



# Department of Defense Legacy Resource Management Program

PROJECT 09-436

## **Rural Industries of the Sand Hills, Georgia, South Carolina and North Carolina Context Report**

Renee Lewis, Fort Gordon  
Joe Joseph, New South Associates

December 2009

# RURAL INDUSTRIES OF THE SAND HILLS

GEORGIA, SOUTH CAROLINA AND NORTH CAROLINA



## PUBLIC VERSION

THE LEGACY RESOURCE MANAGEMENT PROGRAM  
DEPARTMENT OF DEFENSE  
LEGACY PROJECT # 09-436



REPORT SUBMITTED TO:

U. S. ARMY, FORT GORDON • ENVIRONMENTAL,  
NATURAL & CULTURAL RESOURCE MANAGEMENT PROGRAM  
DIRECTORATE OF PUBLIC WORKS • FORT GORDON, GEORGIA 30905

AND

U. S. ARMY CORPS OF ENGINEERS, SAVANNAH DISTRICT  
100 W. OGLETHORPE STREET • SAVANNAH, GA 36628

REPORT PREPARED BY:

NEW SOUTH ASSOCIATES  
6150 EAST PONCE DE LEON AVENUE  
STONE MOUNTAIN, GEORGIA 30083

J. W. JOSEPH, PHD, RPA – PRINCIPAL INVESTIGATOR  
BRADFORD Y. BOTWICK, MA, RPA – ARCHAEOLOGIST AND AUTHOR



J. W. JOSEPH, PHD, RPA – PRINCIPAL INVESTIGATOR AND CO-AUTHOR

DECEMBER 23, 2009 • FINAL REPORT

NEW SOUTH ASSOCIATES TECHNICAL REPORT 1799

## ARCHAEOLOGICAL SITE LOCATIONS

The specific locations of archaeological sites on DOD installations are considered sensitive. Legacy Program guidelines bar the release of this information. If individuals or installations require site location data, it can be requested from the Legacy Program (Project 09-436).



# TABLE OF CONTENTS

INTRODUCTION AND SETTING.....	1
HISTORICAL SETTING.....	4
THE SAND HILLS PHYSIOGRAPHIC REGION IN GEOGRAPHIC PERSPECTIVE .....	5
REGIONAL PERSPECTIVE.....	10
GRIST AND SAW MILLING IN THE WATER AGE .....	13
A CENTRAL ROLE IN PIONEER COMMUNITIES: GRIST MILLS .....	13
“ONE OF THE CLEARLY DEFINED FEATURES OF INDUSTRIAL DEVELOPMENT”: SAW MILLS.....	17
WATER POWER.....	21
THE MILL SEAT .....	30
MILL STUDIES AT SAND HILLS DOD INSTALLATIONS .....	32
FORT GORDON.....	32
FORT BENNING.....	37
FORT JACKSON .....	41
OTHER SAND HILLS DOD INSTALLATIONS .....	42
SPATIAL PATTERNING .....	42
RESEARCH RESULTS AND DIRECTIONS FOR FURTHER STUDY .....	45
FOREST PRODUCTS—NAVAL STORES AND LOGGING.....	49
NAVAL STORES—“THE RESINOUS PRODUCT OF PINE”.....	49
TAR AND CHARCOAL .....	49
TURPENTINE AND ROSIN .....	55
ARCHAEOLOGY OF NAVAL STORES PRODUCTION AT DOD INSTALLATIONS .....	70
SITE LOCATIONS AND DISTRIBUTIONS (GIS DATA) .....	73
RESEARCH RESULTS AND QUESTIONS.....	75
GETTING GOOD WOOD FROM BAD PLACES LOGGING AND LUMBERING .....	78
ARCHAEOLOGICAL EVIDENCE OF LOGGING AT SAND HILLS DOD INSTALLATIONS .....	90
FUTURE RESEARCH.....	90
CLAY INDUSTRIES: POTTERY AND BRICKMAKING.....	93
POTTERY MAKING: THE FICTILE ART .....	93



## TABLE OF CONTENTS CONTINUED

DISTRIBUTIONS AND RESEARCH .....	102
“MANUFACTURED AT MANY LOCALITIES”: BRICKS.....	105
RESEARCH.....	115
“OTHER INDUSTRIES THAT MAKE A GOOD SHOWING”.....	119
BLACKSMITHING—THE WORKING OF IRON AND STEEL IN EVERY BRANCH OF FORGING.....	119
DISTRIBUTIONS AND RESEARCH.....	124
“ILLICIT DISTILLATION IS CONSTANTLY GOING ON”: STILLS AND LIQUOR DISTILLING .....	125
DISTRIBUTIONS AND RESEARCH.....	134
“THE ALL-IMPORTANT CLAYS OF THE FALL LINE BELT”.....	136
KAOLIN.....	138
BAUXITE.....	143
FULLERS EARTH.....	145
COMPONENTS OF SAND HILLS MINING OPERATIONS.....	146
ARCHAEOLOGICAL STUDY OF SAND HILLS MINING.....	147
“FLUFFY MASSES OF COTTON LINT ADHERING TO SEEDS”: COTTON GINNING.....	149
“THE VALUE OF COTTON SEED WAS LONG UNKNOWN”: COTTONSEED OIL.....	156
SITE ORGANIZATION.....	160
DISTRIBUTIONS AND RESEARCH TOPICS.....	162
EVALUATION, MANAGEMENT, AND INTERPRETATION OF INDUSTRIAL SITES IN THE SAND HILLS.....	165
NRHP EVALUATIONS.....	165
EVALUATION OF SAND HILLS RURAL INDUSTRIES ARCHAEOLOGICAL SITES WITHIN A HISTORIC CONTEXT.....	165
INTEGRITY.....	168
EVALUATING THE SIGNIFICANCE OF HISTORIC ARCHAEOLOGICAL SITES.....	172
GUIDELINES FOR EVALUATING AND MANAGING SAND HILLS RURAL INDUSTRIAL SITES.....	175
MANAGEMENT CONSIDERATIONS.....	185
SITE INTERPRETATION.....	187
REFERENCES.....	189



# INTRODUCTION AND SETTING

This historic context for the rural industries of the Sand Hills of Georgia, South Carolina, and North Carolina was funded by the Department of Defense's (DOD) Legacy Resource Management Program (Project #09-436) and was developed from the existing archaeological and historical inventories and evaluations of rural industrial sites associated with six DOD installations located in the Sand Hills geographic region: Fort Benning, Robins Air Force Base, and Fort Gordon, Georgia; Fort Jackson and Shaw Air Force Base, South Carolina; and Fort Bragg, North Carolina. This context identifies the rural industry property types associated with the Sand Hills region, reviews the attributes associated with each, considers each property type or class as identified at the various DOD installations and reviews the significant studies of each, reviews their physiographic distribution, and considers the research attributes of each class of properties. Recommendations for the future management, interpretation, and National Register of Historic Places (NRHP) evaluation of rural industry properties are provided in the concluding chapter.

*Historic Contexts* are defined by the implementing regulations and guidelines of the NRHP. A historic context, or historical context, establishes the historical events, individuals, and physical characteristics of a property type that are critical in determining whether an individual property is eligible to the NRHP as an example of its respective class of resources. The NRHP specifies that historic properties are eligible for listing on the NRHP under one or more of the following criteria:

- (a) association with events that have made a significant contribution to the broad patterns of our history; or
- (b) association with the lives of persons significant in our past; or
- (c) that embody distinctive characteristics of a type, period, or method of construction, or that represent the work of a master, or that possess high artistic values, or that represent a significant and distinguishable entity whose components may lack individual distinction; or
- (d) that have yielded, or may be likely to yield, information important in prehistory or history.

According to the *National Register Bulletin: How to Apply the National Register Criteria of Evaluation* (1990):

*The significance of a historic property can be judged and explained only when it is evaluated within its historic context. Historic contexts are those patterns or trends in history by which a specific occurrence, property, or site is understood and its meaning (and ultimately its significance) within history or prehistory is made clear* (National Park Service 1990).

While the use of historic contexts are applicable to both historic structures and archaeological sites against all of the criteria outlined above, various researchers have noted that contexts are useful for making evaluations of archaeological sites with reference to Criterion D – “information important in prehistory or history.” Evaluation against this criterion requires assessing an individual property’s attributes and their relationship to scholarly research. However, historic contexts are lacking for many archaeological property types, as has been noted by various practitioners and agencies. Impediments to the development of historic contexts for archaeological sites include the lack of excavations conducted on some site classes, the limited distribution and knowledge of many cultural resource management studies conducted in response to Section 106 and Section 110 requirements of the National Historic Preservation Act (NHPA), and the lack of regulatory mechanisms and project funding to develop historic contexts.

This historic context was developed to address this need with specific reference to a class of resources, rural industrial sites, found in a specific geographic setting, the Sand Hills region. Temporally, this context addresses historical industrial sites from settlement (which ranges from the late eighteenth century to the first quarter of the nineteenth century, depending on location) up to 1960, which is the date 50 years from the present that the NRHP uses as a baseline in evaluating historic properties.

While not one of the major physiographic provinces of the southeastern U.S., the Sand Hills played an important role in the industrial development of Georgia, South Carolina, and North Carolina. The Sand Hills have also had a strong association with the DOD. The six installations identified above cover more than 720 square miles of area, a majority of which has been inventoried for archaeological resources. As a result, these installations have compiled a substantial catalog of industrial sites, and have completed detailed evaluations of several of them as a result of various actions and events. The DOD installations thus offer a robust data set that was used to develop this context. The intent of this historical context is that it can be used to guide future resource identification and evaluation studies at the six installations as well as future inventories and assessments at non-DOD properties in the Sand Hills. Finally, the property type descriptions and research questions have utility for researchers working with sites in other regions.

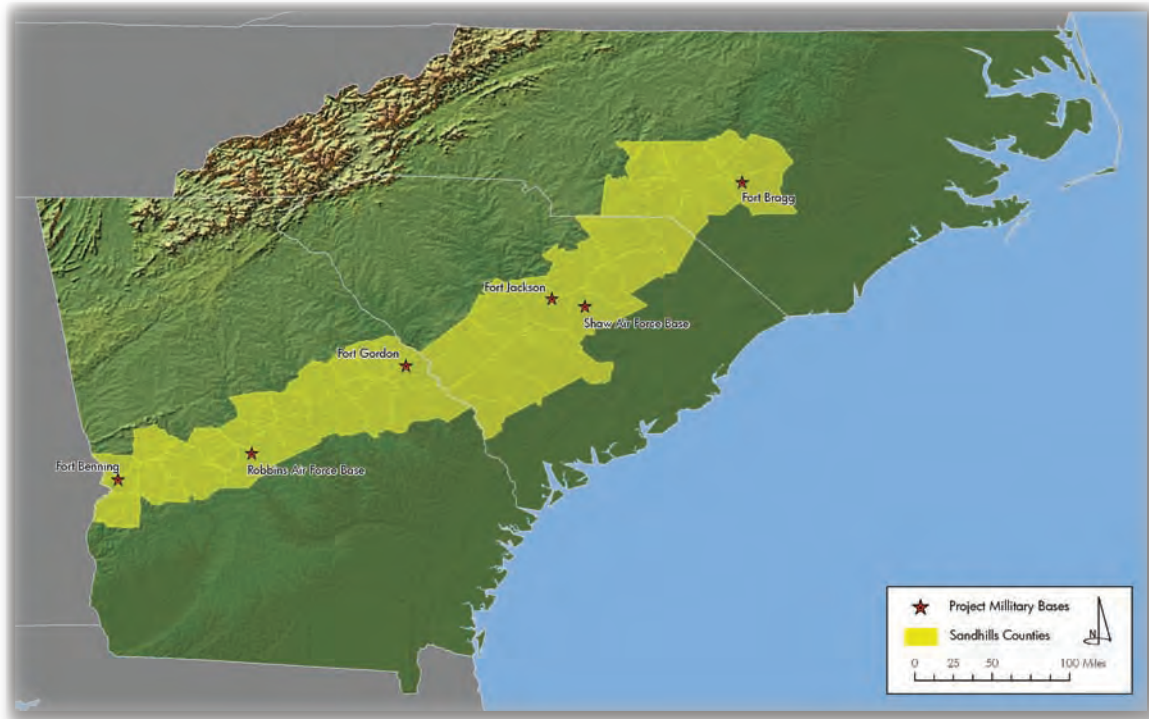

The Sand Hills region extends from North Carolina into Eastern Alabama and is home to six DOD installations distributed across its range.

Completion of this context was the product of a number of hands. Ruth Renee Lewis, Cultural Resource Specialist for Fort Gordon, developed the Legacy Program proposal and project requirements, collaborated on the content and structure of this document, provided information on the resources of Fort Gordon, and served as the project manager. At Fort Benning, Dr. Christopher Hamilton, Acting Director of the Environmental Resources Branch, searched, compiled, and shared the voluminous data sets developed by Fort Benning over the past 30 years. Chan Funk, Archaeologist at Fort Jackson, assisted in our research efforts into the recorded history and archaeology of that installation and provided access to all reports and direction to on-going studies. Dr. Linda Carnes-McNaughton, Cultural Resource Manager CRM at Fort Bragg, likewise shared the installation's reports, site inventory, and resources. As the timber and naval stores industries were more critical facets of Fort Bragg's cultural landscape than they were at the South Carolina and Georgia installations, Dr. Carnes-McNaughton also assisted New South Associates with resources and perspectives on this industry type. Finally, Dave Davis, CRM for Shaw Air Force Base (AFB) and Steve Hammack, Base Archaeologist at Robins AFB, provided industrial reports and resources from their installations, although industrial sites were not as critical a component at either AFB. Judy

Wood of the U.S. Army Corps of Engineers, Savannah District, served as the overall task order manager. Cecilia Brothers is the Legacy Program's Cultural Resources Management Specialist and provided review comments on the document and other projects of this study.

This context is organized as follows. The remainder of this chapter presents the historical setting of the settlement of the Sand Hills region in each of the respective states, reviews the physiography of the Sand Hills region itself, and provides a geo-cultural setting for industrial sites of the Sand Hills using statewide GIS data from Georgia. The context then presents and reviews the data collected for various classes of rural industrial sites. These include saw and gristmills (Chapter 2), naval stores and lumber (Chapter 3), brick kilns and potteries (Chapter 4), and other industrial site types including stills, mining, blacksmith shops, and cotton gins (Chapter 5). Conclusions and Recommendations for the management of rural industrial sites are provided in Chapter 6, while the References Cited follow.

## HISTORICAL SETTING

The three states included in this study – Georgia, South Carolina, and North Carolina – have different histories that are summarized here, since they provide the settings and settlements that would influence the historical development of their respective Sand Hills regions.

All three are among the 13 colonies established by the British Empire. South Carolina is the first of the three to have been settled, beginning in 1670 with the creation of Charles Towne, which was relocated two years later to its current position. South Carolina was governed by the Lords Proprietors until 1729, at which time its administration reverted to the British crown. During the Lords Proprietors administration, "Carolina" was recognized as a single colony, although separate governors were assigned to the northern and southern parts of this large colony. This separation was formally recognized by the crown in 1729, when the colony was split into North and South Carolina (Edgar 1998:35-46; Powell 1989:84-104).

Conflict with Native Americans of the region structured early settlement, which was restricted to the coastal regions. The Yamasee War of 1715 to 1717 represented a major clash between Native Americans of the coast and the British colonists, and the war's successful resolution in the colonist's favor relieved some of the spatial constraints. In its aftermath, the British began to establish outposts in the upcountry, such as Fort Moore along the Savannah River and Fort Congaree on the Congaree River. Because rivers served as the major transportation spines of the era, and because the Fall Line at the upper reaches of the

Sand Hills limited navigation further upstream (see below), the Sand Hills became the focus of interior expansion. Subsequent settlements established in South Carolina's Sand Hills region were all along the major waterways, including New Windsor on the Savannah River, Saxe Gotha on the Congaree, and Fredericksburg on the Wateree. All of these settlements were established by the 1750s (Edgar 1998:131-152).

This era also saw creation of the colony of Georgia along Carolina's western border. Georgia's colonization began in 1732 under the direction of James Oglethorpe, who's intent was that the colony provide an outlet for overcrowded British prisons and the poor. Seeing the presence of Fort Moore on the South Carolina side of the Savannah River as a threat to its desire to control upcountry trade and commerce, Georgia established Augusta on the Savannah River's west bank in 1736 (Coleman 1991). After the coast, the Sand Hills was the second line in the historic settlement of the region. This was true in North Carolina as well, where Fayetteville was formed in 1762 from the merger of two communities on opposite banks of the Cape Fear River, Cross Creek and Campbellton.

The post Revolutionary War years saw the expansion of the settlement of the upcountry and Eli Whitney's invention the cotton gin in 1793 provided the interior with a cash crop that spurred settlement and the removal of the remaining Native American tribes. The post Revolutionary War era saw the formation of a number of Sand Hills cities, often building off of earlier forts and trading posts. Columbia, South Carolina was established as a state capitol in 1786, near the location of Fort Congaree. As westward expansion removed the Creeks and Cherokees from Georgia, Macon was created in 1823 on the Ocmulgee River near the location of Fort Hawkins (constructed in 1806) and Columbus, Georgia was established on the Chattahoochee River in 1828 (Edgar 1998; Coleman 1991). All of these communities shared a reliance on their waterways (the Cape Fear, Congaree and Santee, Savannah, Ocmulgee, and Chattahoochee, respectively) as avenues for receiving and shipping goods and produce, and all used the waterpower of the region for industry. A description of the geology and geography of the Sand Hills, as well as other physiographic provinces, follows.

## THE SAND HILLS PHYSIOGRAPHIC REGION IN GEOGRAPHIC PERSPECTIVE

The natural environment forms a framework within which humans have structured much of their activity. Understanding industrial development in North Carolina, South Carolina, and Georgia must



take into account the physical conditions that people faced. Important aspects of the environment for understanding industrial growth include geology, landscape, watercourses, and natural environments, all of which provided opportunities and constraints to the commercial exploitation of raw materials and their transformation into commodities.

The three states covered by this study encompass five principal physiographic or landform regions. From east to west these are the Coastal Zone, Coastal Plain, Sand Hills, Piedmont, and Blue Ridge/Appalachian Mountains. The one of most relevance to the present study is the Sand Hills, which represent a unique region in the Carolinas and Georgia that overlaps the Fall Line and marks a rough boundary between the Coastal Plain and Piedmont. The Sand Hills have been described differently in the three states. Kovacik and Winberry (1989) treated the region the most explicitly. For Georgia, Clark and Zisa (1976) termed an area roughly corresponding to the region the “Fall Line Hills District” while Wharton (1998:8) divided roughly this same area into the “Fall Line Sand Hills” and “Fall Line Red Hills.” Diemer and Bobyarchick (2005) defined the Sand Hills in North Carolina as a sub-district of the Fall Line. Others (North Carolina State Climate Office 2001; North Carolina Sand Hills Conservation Partnership 2009) recognized the region as a distinct zone, however. In North Carolina, the Sand Hills are less extensive than in South Carolina and Georgia, covering a small area extending only as far north as Harnett and Lee counties.

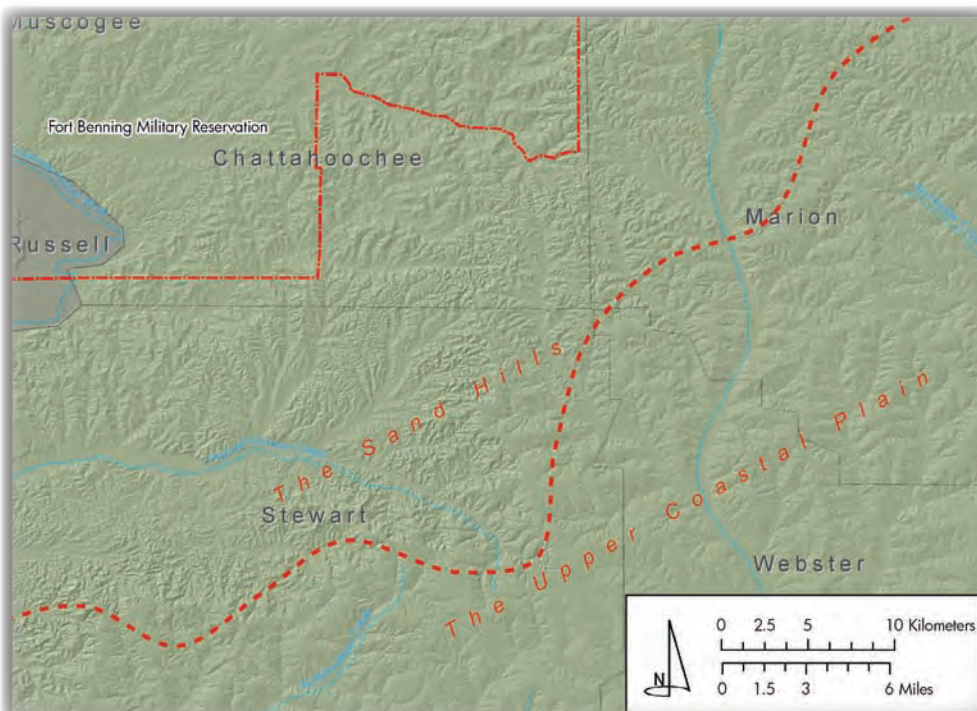

Relief Map of the Fort Benning Vicinity Showing the Change in Terrain from the Coastal Plain to the Sand Hills.



Characteristic Terrain in the Sand Hills. Wilkinson County, Georgia (photo by Brad Botwick).

The region is narrow, approximately 30 miles at most, and discontinuous. Hills are rounded and have gentle slopes and relief is typically moderate, although it becomes more rugged in places, with ridge and hillcrests reaching heights of 50-250 feet above adjacent valley bottoms. It lies higher than the Coastal Plain and reaches heights of 725 feet above sea level (asl) in some areas (Clark and Zisa 1976; Kovacik and Winberry 1989; Murphy 1995:8; Diemer and Bobyarchick 2005).

The Sand Hills originated as an ancient shoreline during a higher stand of the Atlantic Ocean. Rivers carried sand and clay eroding from the mountains to the coast, where the ocean reworked them into beaches and dunes. When the ocean retreated about 40 million years ago, it left these shoreline features inland. Windblown sands and silt also contributed to the creation of these sandy hills (Kovacik and Winberry 1989:18; Diemer and Bobyarchick 2005).





Soils are typically permeable, well drained, acidic, and deficient in plant nutrients due to rapid leaching (Kovacik and Winberry 1989:41; Diemer and Bobyarchick 2005). Areas with low water tables form a “semi-desert” habitat supporting species adapted to these conditions. Plant species that thrive here include turkey oak, longleaf pines, various cacti, briars, and berries (Murphy 1995:9). The vegetation exhibits irregular distributions, broken canopies, and areas of bare soil. The natural forest cover was long leaf pine. Frequent natural and human-made burning helped this fire-resistant species flourish by burning off much of its competition. Long leaf pine survives in the Sand Hills, but because fires are now controlled, other species, such as turkey oak, a low scrubby variety, now proliferate. Also, cultivated loblolly and slash pine have been introduced for forestry industries (Kovacik and Winberry 1989:44).

Pine is the natural forest cover in the Sand Hills. Fort Gordon, Georgia (photo by Diana Valk).

Modern activities have allowed turkey oak and other species to thrive in the Sand Hills. Shaw Air Force Base, South Carolina (Photograph by Mason Sheffield).



The Sand Hills contains numerous natural resources that were and/or are important to regional industries. Mineral resources include sand, especially industrial sand (Carpenter et al. 1995). Eolian deposition in some areas produced very pure silica sands that are mined extensively in Lexington County, South Carolina area (Murphy 1995:94). The Sand Hills also yield a variety of clays with industrial uses, the chief among these being kaolin, a white clayey rock composed of khandite minerals, mainly kaolinite. Kaolin found in the Sand Hills is a sedimentary material derived from weathered igneous and metamorphic rocks of the Piedmont (Schroeder 2003). It has been and continues to be mined extensively in Georgia and South Carolina (Schroeder 2003; Mining Association of South Carolina 2009). Other Sand Hills minerals with past or current economic importance include gravel, fuller's earth, and bauxite.

Sand Hills vegetation also had commercial significance before it was largely replaced with introduced species. In particular, the extensive stands of long leaf pine were extremely significant to the naval stores industries of the Carolinas and Georgia as well as the lumber industry. Planted pines remain important for lumber and pulpwood.

The Sand Hills overlies portions of the Fall Line and it is worth describing this related geophysical feature. The Fall Line, as noted, marks the zone where the Coastal Plain meets the Piedmont and is marked by changing stream characteristics. Geologically, this is the point where the younger and softer Coastal Plain sediments meet the older, crystalline rocks of the Piedmont. Because the Coastal Plain materials are softer, they are more extensively eroded. As watercourses make the transition from the Piedmont, they drop down to the lower Coastal Plain. Where the resistant Piedmont rocks are exposed, they form falls and rapids (Clark and Zisa 1976; Diemer and Bobyarchick 2005).

Historically, the Fall Line was closely related to settlement and the development of certain industrial activities. The region marked the furthest inland point that ocean-going sailing vessels could reach, making it a good location for port towns and commercial centers. Furthermore, the changes in stream gradient provided important sources of waterpower. The early growth of manufacturing plants in South Carolina, for example, took place in the lower Piedmont and Fall Line area (Kovacik and Winberry 1989:98) because of the combination of waterpower and access to commercial and shipping facilities.

## REGIONAL PERSPECTIVE

The Sand Hills association with industrial development is a product of several factors: the availability of mineral resources of the region, the use of the Fall Line for water powered industries, and the presence of upland towns and cities requiring industrial products such as lumber, flour, and meal.

Georgia's NAHRGIS (Natural, Archaeological, and Historical Resources Geographic Information System) was consulted to develop a regional perspective on industrial sites in that state. NAHRGIS contains records of 1,254 industrial sites (including both archaeological sites and historic structures) that have been recorded in Georgia. These include Agricultural Processing Sites, Blacksmith Shops, Breweries, Brickyards, Cotton Gins, Distilleries, Extractive Sites, Factories, Forges, Furnaces, Kilns, Manufacturing Sites, Mills, Mines, Potteries, Quarries, Stills, Tanneries, Warehouses, and Woodworking sites. Some of these classes of sites are broadly defined; for example, "Kilns" contains tar kilns, charcoal kilns, and pottery kilns. Of these 1,254 resources, 712 (56.78%) are archaeological sites.

## INDUSTRIAL SITES BY REGION

Resource Type/Region	Mountains	Piedmont	Sand Hills	Coastal Plain	Coast	Totals
Agricultural processing		1				1
Blacksmith Shop	1	5	1		1	8
Brewery					1	1
Brickyard	1	4	1		1	7
Cotton Gin	1	14	1	4		20
Distillery					1	1
Extractive facility or site	1					1

Resource Type/Region	Mountains	Piedmont	Sand Hills	Coastal Plain	Coast	Totals
Factory		3		2	2	7
Forge		2			1	3
Furnace		4	1	1		6
Kiln	1	15	11	1	3	31
Manufacturing		1		1		2
Mill	76	302	73	127	35	613
Mine	66	152	1	1		220
Pottery			1			1
Quarry	3	20	1	6		30
Still	20	184	18	29	42	293
Tannery		2	1			3
Warehouse	1			4		5
Woodworking		1				1
Total	171	710	110	176	87	1,254

Mills are the most common industrial sites recorded in NARHGIS, accounting for 48.88 percent of all industrial sites. Stills are next most common, with 293 resources or 23.36 percent of the total. Mines represent 220 sites, or 17.54 percent of the total number of industrial sites. In combination, these three classes of sites represent nearly 90 percent of all industrial sites and no other site type accounts for more than 31 resources.

By region, the Piedmont contains the greatest number of sites, accounting for 56.62 percent of the total. This figure is somewhat skewed by sampling bias, and the presence of Atlanta, the state capital, in the Piedmont. The Atlanta metropolitan area has experienced a large number of Phase I Cultural Resource Surveys in response to development, road construction, utilities, and infrastructure, which has resulted in a higher percentage of areas surveyed and a greater number of sites recorded.

The Coastal Plain is next in total number of sites, with 14.04 percent, followed by the Mountains region, representing 13.64 percent. The Sand Hills contain 8.77 percent of the recorded resources.

These regional distributions are skewed by the size of the physiographic regions. Spatially, the Coastal Plain is the largest, containing 27,634 square miles (sq mi) (~17,685,483 acres). The Piedmont is next with



17,824 sq mi (~11,407,181 acres). The Sand Hills is the smallest of the physiographic provinces, containing only 2,971 sq mi (1,901,410 acres). Looking at the distribution of industrial sites by area, there is a clear difference in the distribution of sites in the upland regions (including the Sand Hills) versus the Coastal Plain and Coast. The density of recorded sites per sq mi in the uplands is tightly clustered, with one site per 25.10 sq mi in the Piedmont to one site per 29.19 sq mi in the mountains. Sand Hills industrial sites have the second highest density in the state, after the Piedmont, at one site per 27.00 sq mi. The site densities in the Coast and Coastal Plain are significantly lower, at one per 157.01 sq mi and 60.65 sq mi, respectively. Notably, the frequency of mill sites is highest in the Sand Hills, averaging one mill per 40.69 sq mi. Mill sites in the Piedmont were found at a rate of one per 59.01 sq mi., in the Mountains at a rate of one per 65.68 sq m, along the Coast at a frequency of one per 150.77 sq mi, and in the Coastal Plain at a rate of one per 217.59 sq mi.

The recorded resources of the three Georgia DOD installations reflect the general trends seen above, and further illuminate distributions. Considering Fort Benning, Fort Gordon, and Robins AFB, six types of industrial sites are recorded: blacksmith shops, kilns, mills, mines, quarries, and stills. A total of 54 resources are recorded on the installations; of these, 29 (53.70%) are mills. This is a percentage distribution that is higher than seen for the state as a whole, but less than seen as the percentage of all Sand Hills industrial sites; 66.36 percent of all industrial sites in the Sand Hills are mill sites.

The densities of mill sites on the Georgia DOD installations also appear to reflect geographic trends noted above. Fort Benning, at 284.37 sq mi in area, contains 33 industrial sites, or one per 8.61 sq mi. Fort Gordon, which is 87.08 sq mi in area, contains 20 sites, or one per 4.35 sq mi. Robins AFB, at 13.68 sq mi, contains only a single site. The densities of all are higher than the recorded density of industrial sites in the Sand Hills (1 per 27 sq mi), which is a product of the intensive survey all three have received. Robins AFB, which is partially located in the Coastal Plain, contains the lowest industrial site density, reflecting the trend noted above.

Notably, Fort Gordon contains the highest number of mill sites from the three installations (n=15) as well as the highest density of mills, at one per 5.44 sq mi. In comparison, Fort Benning contains 13 mills and a density of one per 21.87 sq mi. The next chapter of this context looks at historic mill sites as a resource type.



## GRIST AND SAW MILLING IN THE WATER AGE

Among the most important and early industries in the Sand Hills, gristmills and sawmills processed crops and forest products through the nineteenth and into the twentieth centuries. Although these two industries handled distinctive materials, they shared certain features in terms of how they were set up and operated. Both types of mill drew power from the region's streams. Often saw- and gristmills lay near one another, powered by the same stream or millpond, and sometimes they were owned by the same operator (Jeane 1974). For these reasons, they are discussed under the same heading. Large water-powered manufacturing mills were also established in the Sand Hills. Such operations, producing textiles, gunpowder, and other commodities, tended to concentrate in urban areas. Smaller establishments serving the needs of local communities to process grain and timber were more common and widely distributed throughout rural parts of the Sand Hills.



Leitner's Grist Mill, Prior to Demolition. Fort Gordon, Richmond County, Georgia, circa 1940. (courtesy of Fort Gordon)

### A CENTRAL ROLE IN PIONEER COMMUNITIES: GRIST MILLS

Gristmills processed grain into meal or flour. The term "grist" technically refers to ground corn, but in practice a gristmill would handle both corn and wheat (Messick et al. 1997:42). In the Sand Hills, corn was the principal grain put through the mills and they turned out mostly cornmeal and

Label for Eelbeck Mill Meal, circa 1920s (Oakley 1992).

animal feed (Reed et al. 1994:192). Grist- and flourmills could be the same or separate operations. A business described as a flourmill, however, specialized in flour for commercial markets rather than custom work (Jeane 1974:36). "Custom work" referred to the practice of farmers bringing their corn to the mill to having it ground for their own use, the miller keeping a portion of the product as payment. This was the main practice in the Sand Hills (Reed et al. 1994:192).

Milling in rural areas served primarily as a source of extra income rather than a primary occupation. Most mills were small, ran a single set of stones, had limited capacities, and performed custom work (Jeane 1974:90). Mill sites identified at Fort Gordon and its vicinity conformed to this description from the nineteenth to the early twentieth centuries (Reed et al. 1994). The pattern was not entirely universal in rural

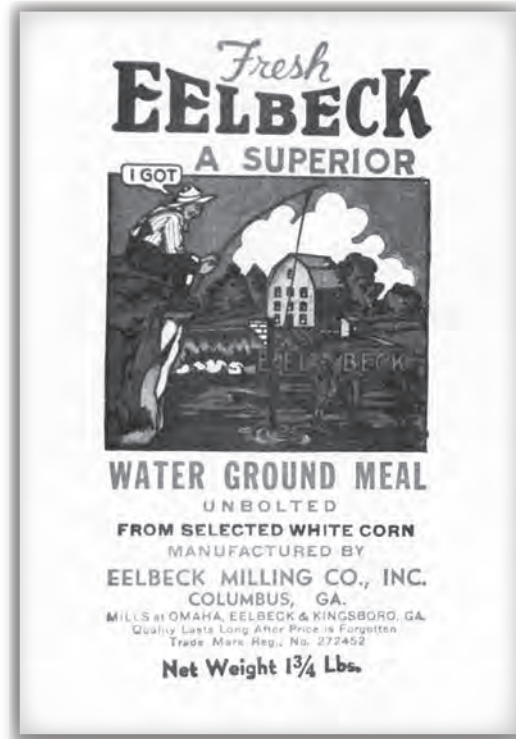

The Power Train of a Water-Powered Grist Mill (McVarish 2008)

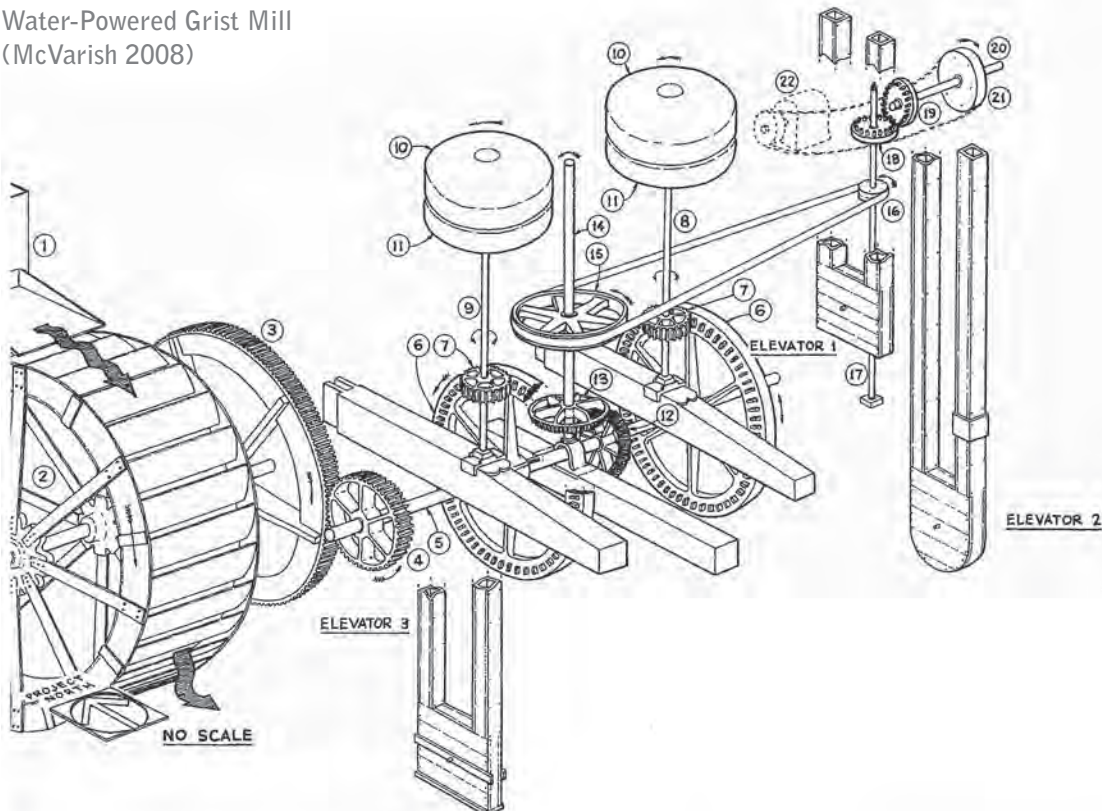

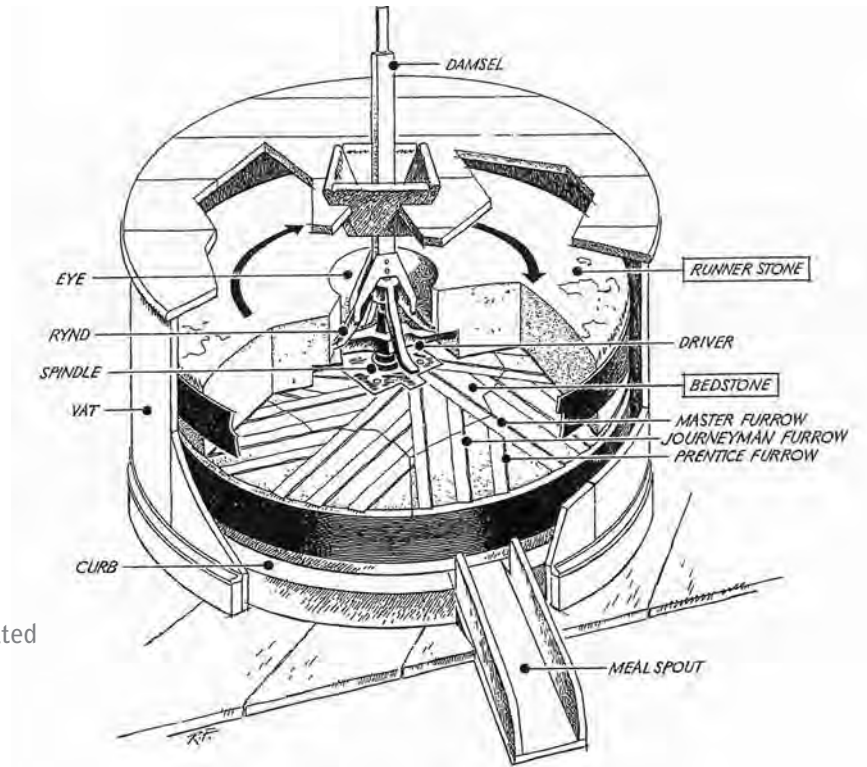

Diagram Showing  
Millstones and Related  
Grinding Elements  
(Howell 1976)

districts, however. At Fort Benning, Cook's Mill at Eelbeck developed into a "merchant mill," a commercial operation that produced meal for markets beyond the local community. By the end of its operating life in the twentieth century, this mill ran three sets of stones and was affiliated with other mills under the auspices of the Eelbeck Milling Company (Smith 1992).

Gristmilling technology remained relatively stable for hundreds of years. In the more familiar example of a water-powered gristmill using a vertical waterwheel, the wheel rotated a horizontal shaft that in turn operated a vertical gear. This gear meshed with a smaller horizontal gear or pinon that drove the vertical shaft supporting the millstones, which were housed in a wooden casing. The principal changes to this system consisted of introducing metal components and replacing cog gears with bevel gears (Jeane 1974:30). A simpler system involved a horizontal waterwheel connected directly to the stones with a vertical shaft. Horizontal waterwheels in the United States were known as "tub wheels." These relatively simple systems were common and persisted into the twentieth-century in some parts of the country (Hunter 1979:73).

Millstones were typically made locally (as opposed to imported from abroad) and varied in diameter and thickness. The types of stone used depended on what was available (Sass 1990). Examples identified at Fort Benning included two made from granite (at an unnamed mill at Site 9RU424) and one made from a "cherty material" (possibly a siltstone or limestone) at Woodruff Mill (Site 9CE1735). A series of grooves and channels carved into the grinding surfaces cut the grain and allowed it to work its way outward and



Eelbeck Mill, Illustrating the Size of a Typical Large Gristmill. Fort Benning, Chattahoochee County, Georgia, circa 1940 (Cowie 1992).



Interior of Leitner Mill Showing the Stone and Meal Floors. Fort Gordon, Richmond County, Georgia, circa 1940 (courtesy of Fort Gordon).

Diagram Showing the Process of Grinding Grain in a Water-Powered Mill (Palmers and Neaverson 1998).

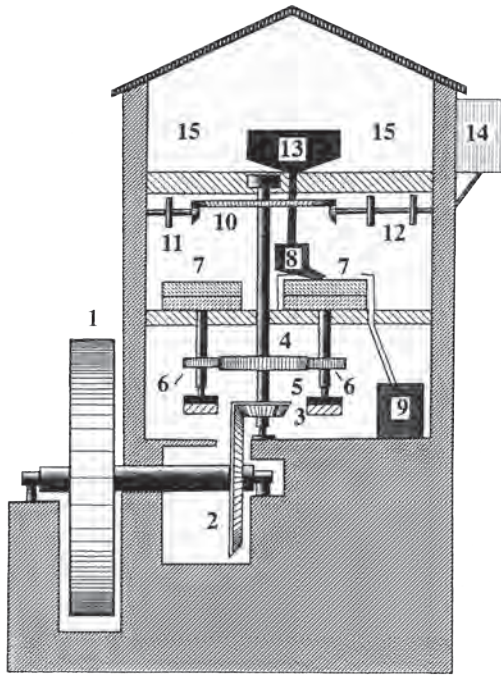

*Figure 13* Diagrammatic section of water-powered corn mill with a vertical wheel driving several pairs of stones and auxiliary machinery via gearing. 1 – Waterwheel, 2 – Pit wheel, 3 – Wallower, 4 – Main shaft, 5 – Great spur wheel, 6 – Stone nuts, 7 – Millstones (upper driven), 8 – Grain hopper and feed shoe, 9 – Meal bin, 10 – Crown wheel, 11 – Auxiliary machine drive pulley, 12 – Sack hoist and auxiliary machine drive pulleys, 13 – Grain bin, 14 – Lucam, 15 – Grain storage.

into the wooden casing where it emerged from a spout on one side (Jeane 1974:31-32). The mill building consisted of a two- or three-story structure with stout timber framing to support the weight of heavy, vibrating machinery. The gears and power train were in the basement. The first floor was the meal floor while a half story above it was the stone floor. The upper story was used for storage, sifting, and other activities related to the milling process and might also contain bins for feeding the stones (Jeane 1974:93; McVarish 2008:237). The basic operation entailed first pouring grain into the millstone hopper or feeding it from a bin on the floor above. As the millstones began to turn, the miller lowered the runner stone (the upper stone) to the stationary stone, producing an increasingly finer product (McVarish 2008:240-241).

## “ONE OF THE CLEARLY DEFINED FEATURES OF INDUSTRIAL DEVELOPMENT”: SAW MILLS

Although saw- and gristmills shared certain aspects of site location, distribution, and community relations, once lumber production became more industrialized in the later nineteenth century, southeastern sawmills developed along different lines. These variations are worth highlighting to provide further context for these site types.

Water-powered sawmilling appeared in the colonial period and finally all but replaced hand sawn building materials by the end of the American Revolution. Until the mid-nineteenth century when steam-powered machinery and other mechanical, technological, and transportation innovations brought significant changes to the lumber industry, mechanical saw milling fell into two categories: commercial milling for markets out of the region and small-scale milling intended for local or small regional markets. Large

commercial sawmills concentrated along the coast where river and ocean access facilitated transportation of their larger output. Smaller mills, mainly supplying local markets, were scattered throughout the region (Bishir et al. 1990:196). Many operators of small-scale mills ran them only seasonally or to meet specific lumber orders (Bishir et al. 1990; Reed et al. 1994:197).

Water-powered sawmills were the most common type until the last quarter of the nineteenth century. Steam power was available by mid-century, but its use was confined to the larger cities. Smaller regional mills did not adopt them immediately because the small annual production of these mills did not yield large enough returns on the investment in steam equipment. The equipment was also difficult to obtain and bring to a rural district without adequate land transportation and there were few mechanics in these areas that could install and maintain it (Bishir et al. 1990:208-211). By the early 1900s, however, the lumber industry was almost universally steam powered (Compton 1916:36).

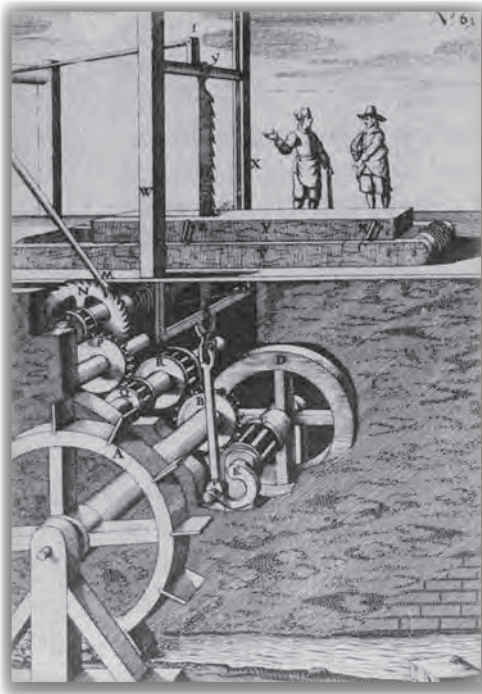

Sawmill with a Single Straight Blade  
(Peterson 1976).

Early sawmills mechanized the process of making lumber with a single straight saw. In a water-powered mill, a crank connecting the saw blade and waterwheel converted the wheel's energy to an up-and-down motion. An overhead spring pole maintained tension on the blade, keeping it taut while guide blocks on either side of the blade exerted side pressure to keep it cutting straight. A later development entailed stretching the single saw blade in a wooden frame, or sash (Bryant 1922a:3-4). In early mills, the carriage that moved the log forward was adjusted by hand (Compton 1916:36). Eventually, power from the saw sash was diverted to a gear called a "rag wheel," which pulled the log carriage across the saw when the blade recoiled on the upstroke (Evans 1848).

Technological developments included the introduction of the circular saw, a round metal disc with teeth around its circumference, and the gang saw that mounted multiple straight saws side by side in a sash and cut a single log into several boards at one pass. Neither of these developments was entirely satisfactory because they produced considerable amounts of waste. Moreover, gang saws required strong continuous power



Varieties of Circular Saws. The lower example is powered with a turbine and belting system (Bishir et al. 1990).

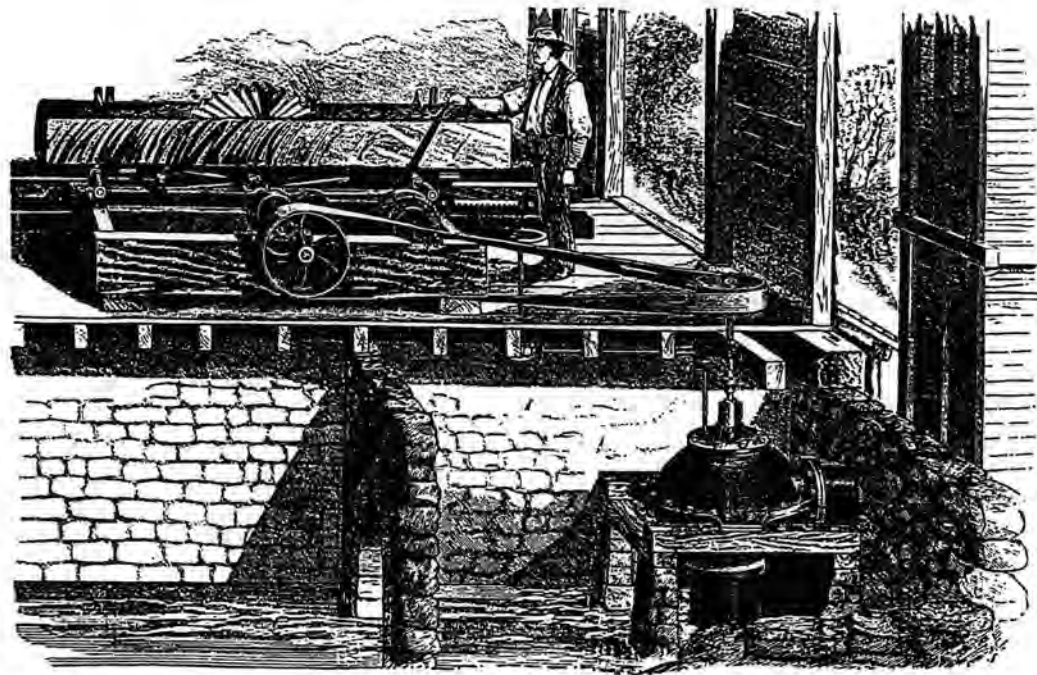
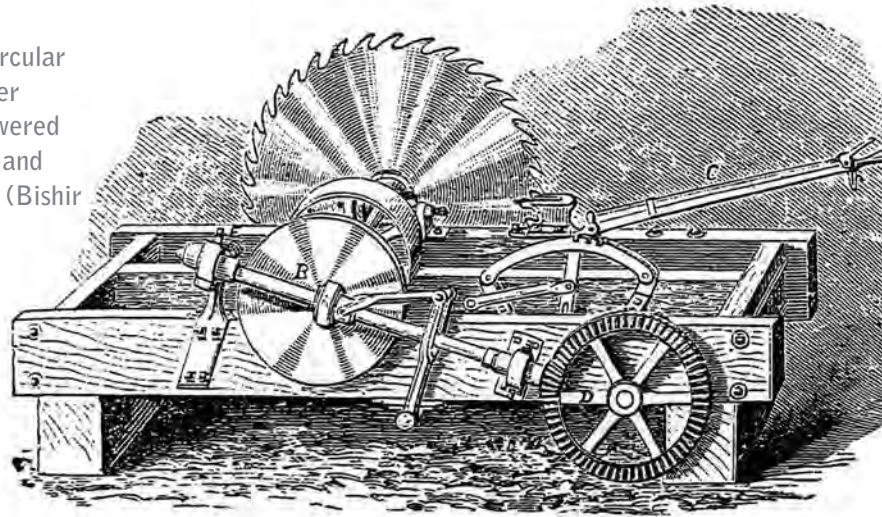

that water mills could not always provide. Steam engines were adopted primarily in conjunction with gang saws. In addition to waste, circular saws had the additional problem of wobbling at high speeds, which produced an uneven cut face. By the 1880s, however, these problems were overcome and circular saws quickly replaced sash saws (Compton 1916:37; Bishir et al. 1990; Reed et al. 1994:197). By 1880, almost 90 percent of North Carolina sawmills operated circular saws (Bishir et al. 1990:206). Finally, the band saw was introduced in the 1880s and by the turn of the twentieth century had become common in southern mills except for the smallest ones, which continued to operate circular blades (Compton 1916:38).

Water Powered Gang Saw (Sloan 1965).

Other innovations included the endless chain for running the log onto the mill; direct steam feed, which replaced rope or belt and friction devices; and various appliances to handle the logs, the lumber, and the debris. Mechanical devices were also developed to recycle waste into the furnaces used for steam engines. In addition to sawing up logs, sawmills added kilns, thus eliminating the lengthy seasoning process of air-drying cut lumber (Compton 1916:36-37).

As steam power became more common and transportation technology improved, sawmills gained greater flexibility in terms of locations, no longer being tied to permanent water sources and water navigation. In the South, lumber producers found no significant benefits in concentrating production in large mills. Although such mills could turn out more board

feet annually, the financial gains did not pay back on the investment. Additionally, it was more economical to place the mill closer to the timber supply than to bring logs over long distances. The optimal arrangement called for greater numbers of medium-sized mills. In pine regions producers holding large timber tracts thus tended to build several mills rather than a single large one and it was normal to find mills in multiple locations turning out the same products under the same or affiliated ownership (Compton 1916:40).

An alternative to building several mills was to utilize portable sawmills. These could be taken apart, moved, and re-established at a new location over the course of a few days. A second alternative to a large permanent plant was the semi-portable sawmill. The main difference between this type and the portable variety was that the semi-portable plant usually possessed a rough structure housing it as well

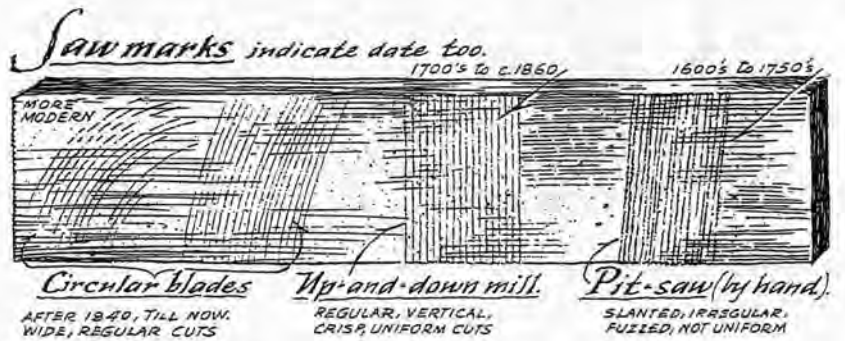
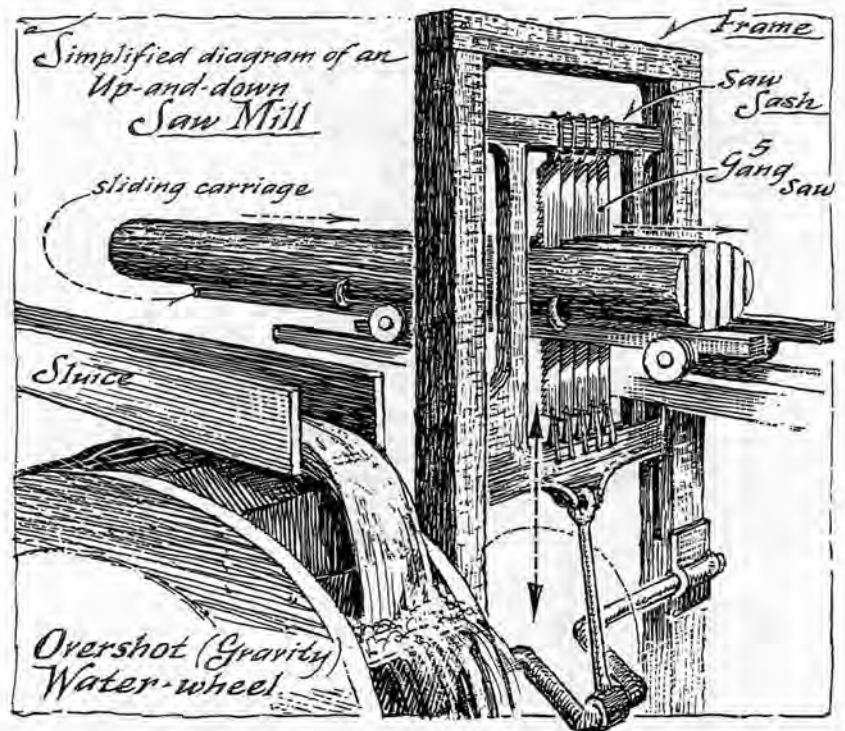





Portable Sawmill, Newberry County, South Carolina (courtesy of South Carolina Forestry Commission).

Portable Sawmill Showing the Circular Saw, Steam Engine, and Belting System. Newton County, Georgia, unknown date (Georgia Archives).

as a greater variety of equipment for more complete processing of the logs (Bryant 1922a:4- 5). In practice the semi-portable plant might be equivalent to the medium-sized mills established in several locations.

## WATER POWER

In rural districts, water-powered grist- and sawmills were the principal facilities for processing grain and lumber. Both types of mill had similar requirements for power and location, and therefore they shared basic components and were arranged in roughly the same way (Jeane 1974). The following overview describes the operation of small water-powered mills and their arrangement. In addition, the major elements of a mill seat are discussed.

Water-powered mills derived energy from the drop in a body of water and the rate of flow. Power was generated by the height of fall, known as the “head.” The position of the mill, along with certain features of the site, could be manipulated to increase the head. Stream flow was fixed and could not be increased, although it could be evened out and made more reliable by adding reservoirs.

The basic elements of a mill site were the millhouse, the millrace, and the dam. The millrace consisted of an artificial channel that took water from the stream to the mill and returned it to the stream. The

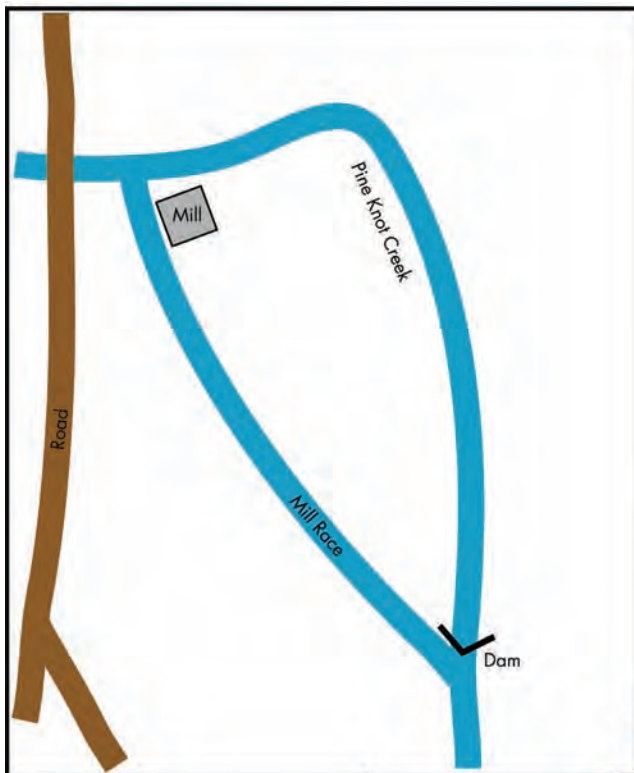

Schematics of Water-Powered Mill Layouts Showing Principal Elements

A. With Mill Race. Based on Eelbeck Mill, Fort Gordon, Chattahoochee County Georgia. (Cowie 2000)

B. Without Mill Race. Based on Maxwell/Read Mill, Fort Gordon, Richmond County, Georgia. (Reed et al 1994)

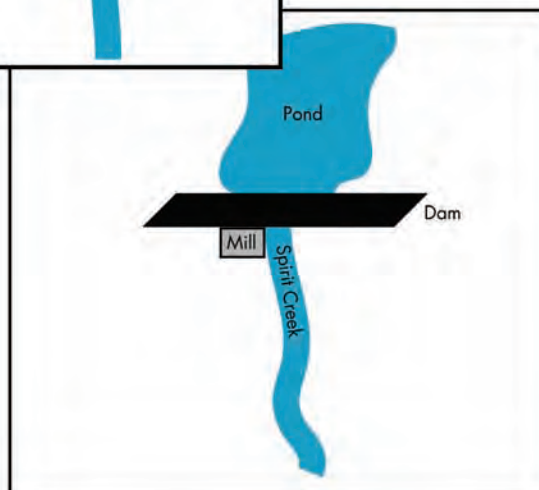

upstream segment, which took the water from the stream and delivered it to the mill was the headrace, while the tailrace carried the water away from the mill.

The headrace typically consisted of an earth, wood, or stone channel that tapped into the watercourse upstream from the mill, and typically above a shoals or fall, which increased the head. The race could extend several hundred feet, inclining slightly along its course, and in the process gaining 10 to 15 feet in elevation before dropping the water onto the wheel (Jeane 1984).

Another element of a mill seat was the dam, “the most prominent feature of a water mill and the least dispensable” (Hunter 1979:54). An artificial barrier across the stream, the dam could consist of a simple structure for diverting the water flow into the headrace or a more substantial construction that raised the height of the fall and increased the power potential of the site. (Power potential of a site was expressed as horsepower, which equaled weight of water multiplied by the height of fall in a given time. Thus, 550 foot-pounds per second was one horsepower). Two basic arrangements were possible in establishing the dam. One was to create a storage reservoir behind the dam. The reservoir collected water that would otherwise flow downstream and be wasted during off-hours. Saving this water could substantially extend to the daily operation. Additionally, if large enough, it helped smooth out seasonal fluctuations in water availability. Building a reservoir depended on the right conditions upstream: high banks and no low-lying pasture or cropland that would incur damage payments to another landowner. If the fall could not be increased sufficiently with the dam alone, the millrace could be used to augment it or provide the majority of the necessary height. In this case, the dam was placed a distance above the falls and the headrace carried the water on a course with enough gradient to deliver the necessary volume of water to a point where it reached the desired head. This system had the advantage of avoiding extensive flooding and damage to productive land above the dam and allowing the mill to be placed above the reach of most floods (Hunter 1979:54, 58).

Dams exhibited considerable variation. Mill engineer James Leffel (1881) discussed factors that influenced dam construction, including its setting and the available construction materials. Stone was the optimal building material, but often was not available, particularly in coastal plain settings. In the Sand Hills, stone was not always available in surface deposits, but could be found in river and stream cuts as well as in the adjacent Piedmont region. Wood was the most ubiquitous and easily obtained building material in the Sand Hills, and was commonly used for dams. These could take various forms. Log dams, consisting of courses of felled trees laid into a wedge-shape, were practical for regions with sandy soils. Wooden or metal spikes secured the logs, while they were sealed with a covering of earth, branches, and other



debris. The crib dam consisted of two log-built wings embedded in the stream banks and connected by a barrier made of stacked logs backed with earth. A third type, the “hollow frame dam,” was composed of a heavy timber frame or crib filled with stones or gravel, sheathed with wooden planks, and covered with earth. Leffel (1881) called a fourth variety “a safe and economical dam.” This consisted of a version of log-crib dam in which logs were embedded across the stream bank and successive courses of logs were laid on top of these to form a wedge pointing upstream. As with the hollow frame dam, the cribs or compartments formed by stacking the logs were filled with rock or gravel. A final type Leffel described was a pile dam, built of pilings driven into the streambed and then sheathed with horizontal logs and earth. This type was recommended for streams with muddy bottoms. In locations near urban areas, brick might be utilized for dam construction. In Richmond County, Georgia, mills that continued operating into the twentieth century sometimes used poured cement to replace older dams and other structures (Reed et al. 1994; Botwick et al. 2003; Norris et al. 2005). In many instances, the wood or cement dams were tied to the banks with earthen levees or embankments that served as abutments and helped contain the millpond.

### Mill Dam Types (Leffel 1881)

Crib Dam

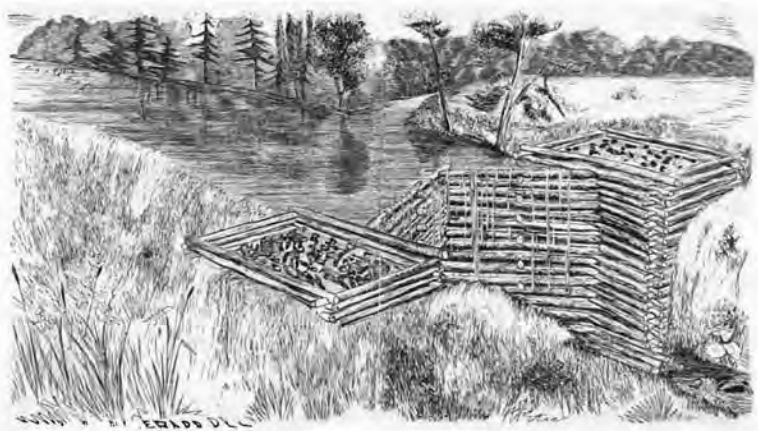

Hollow Frame Dam



Pile Dam

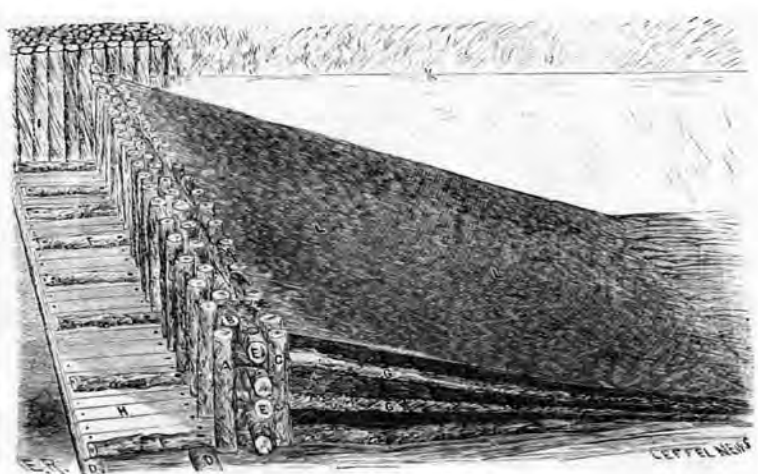



Archaeological Remains of Mill Dams



A. Earthen Mill Dam Remnant, Site 9RI1044, Fort Gordon, Richmond County, Georgia (Photo by Diana Valk).

B. Wooden Structural Remains, Eelbeck Mill Dam (Site 9CE1734), Fort Benning, Chattahoochee County, Georgia (Cowie 2000).

C. Timber Frame Dam Remains, Garners Mill (38RD536/620), Fort Jackson, Richland County, South Carolina (Dawson et al. 2007).

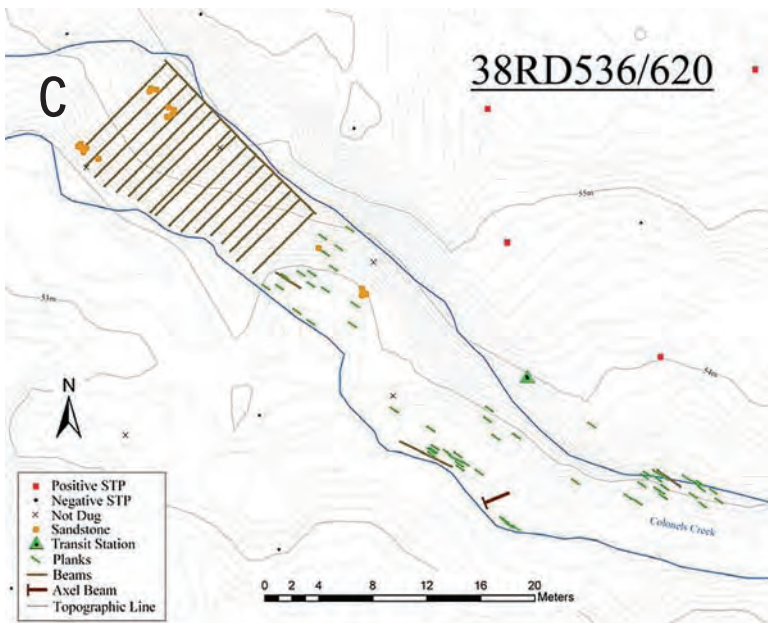

Waterpower was exploited by having the stream or falls turn a wheel or turbine, which in turn operated a series of gears or belts that powered the mill equipment. Different types of wheels, with varying gearing existed. Although all relied on water for energy, they produced different percentages of efficiency (Jeane 1974:27). Hunter (1979:61-62) characterized the basic design and operation of a waterwheel as "simplicity itself."



*[The waterwheel consisted of] a circular structure of varying diameter and breadth around the circumference of which at regular intervals were arranged floats or buckets for intercepting the falling water and capturing a portion of the energy produced by the fall of water in a given volume from a higher to a lower level. For the height of fall and volume of flow available at the mill seat, the capacity of a waterwheel depended upon the type and dimensions of the wheel, its efficiency in the use of water, and its design, construction, and installation. Rotating speeds, measured in revolutions per minute, varied inversely with the diameter of the wheel. The quick motion desired in small gristmills with horizontal wheels and in the undershot "flutter" wheel driving the up-and-down saw directly through connecting rod and crank in the sawmill was obtained commonly by wheels ranging roughly between three and five feet in diameter. The undershot, breast, and overshot wheels on which mills and manufactories chiefly relied were given diameters appropriate to the medium range of falls characteristic of the eastern United States. Such wheels, with diameters usually ranging from eight to thirty feet, revolved much slower, typically between twenty and five rpm, with speeds decreasing as diameters increased. Waterwheels . . . relied largely on gearing and on cam takeoffs on wheel shafts to obtain the operating speeds required in most manufacturing operations.*

Hunter (1979:62) went on to say that the traditional "water motor" involved a single moving part, the wheel, which could be built with simple tools and skills. On the other hand, considerable skill and experience were required to determine the best wheel type and size for a specific purpose at a particular mill site.

The three principal types of water wheels used by industrial-scale milling operations were overshot, undershot, and breast. Another variety, the tub wheel, was mostly used in small-scale establishments, but was common and persisted into the twentieth century. Turbines were a later development that came into common use during the second half of the nineteenth century (Jeane 1974).

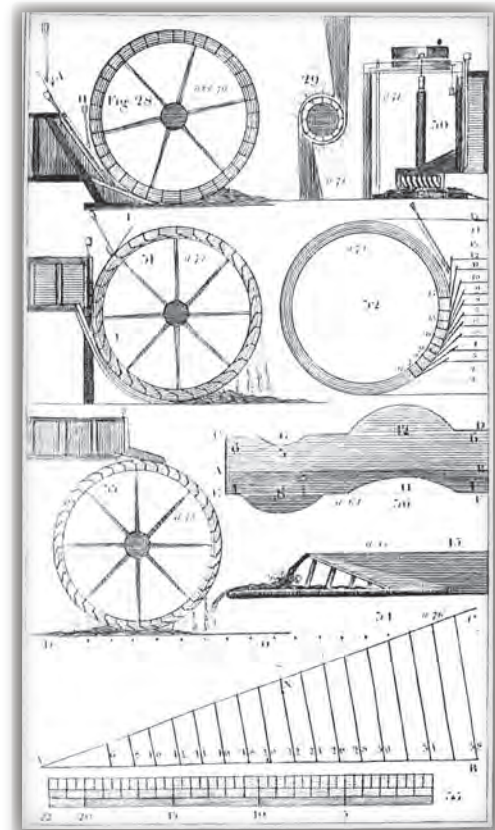

Examples of Mill Wheels (Evans 1858).

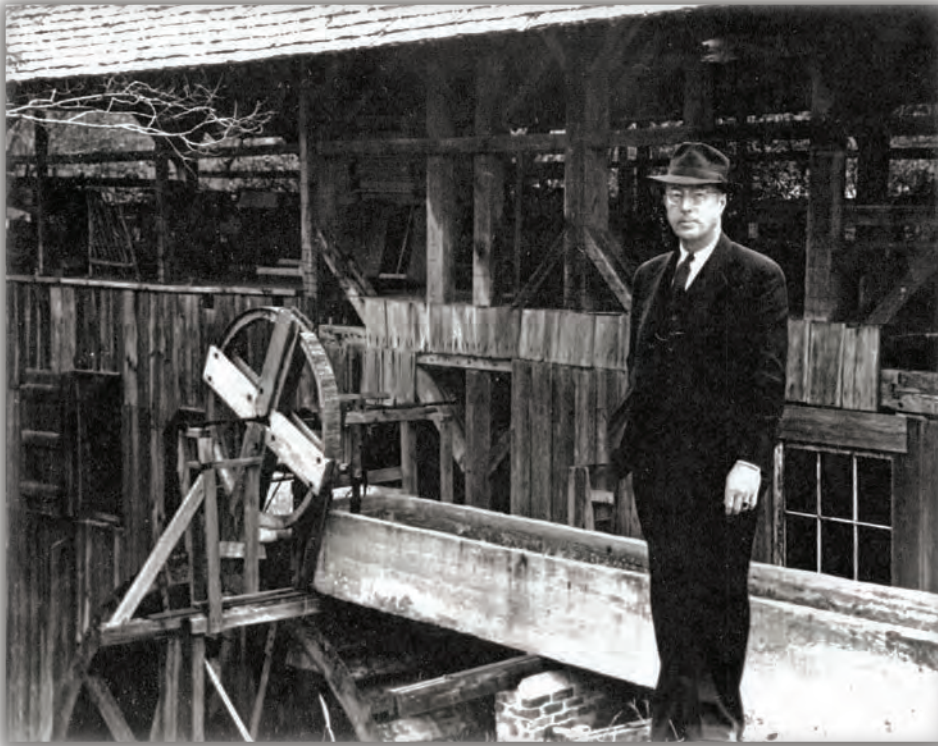

Overshot Wheel at Boardman Mill, Fort Gordon, Richmond County, Georgia, circa 1940 (courtesy of Fort Gordon).

The most common type of waterwheel was the overshot wheel, so-called because the headrace emptied at the top of the wheel, tangent to its circumference. Overshot wheels were efficient and relatively easy to build. The main drawback was that it was difficult to control the power generated by this system. Also, with this type, water could more easily back up into the wheel pit, creating a drag on the wheel and reducing efficiency. This type of wheel was most commonly installed in the upper reaches of a stream, below a dam (Jeane 1974:29).

Overshot Wheel, Woodruff Mill (Site 9CE1735), Fort Benning, Chattahoochee County, Georgia (Cowie 2000).



With the breast wheel, the water struck on the upstream side at about the point where the axle lay. Compared to overshot wheels, the power generated by breast wheels was easier to control and, because they rotated outward from the bottom, breast wheels moved the backwater out of the wheel pit, whereas the overshot wheel tended to scoop it back into the pit. Breast wheels were suitable for locations where large

falls could not be had, and could substitute for overshot wheels (Jeane 1974:29). Both of these types of wheel were common in the Sand Hills.

The undershot wheel was a third type. The water met the wheel at its lower tangent, and simple versions involved placing the wheel directly in a stream, letting the natural current turn it. This type generated less power than the overshot and breast wheels because it relied entirely on stream velocity instead of combining speed with head. However, its simplicity made it a good choice for small operations or locations with low fall or large quantities of water. They were most common in lower, wider reaches of a stream (Jeane 1974:28).

A fourth variety was the tub wheel, which like the other types turned as water pushed against a series of paddles. In this case, however, the wheel was set horizontally and placed inside a wooden casing (the "tub"). This type achieved high speeds and because the waterwheel was horizontal, it could be connected directly to the stones without intermediate gears. Horizontal wheels ultimately led to the development of the turbine.

Turbines maximized the efficiency of water flow. They can be classified as impulse or reaction types. Impulse turbines operate as fast-moving fluid is directed at the blades, which are bucket shaped to deflect the flow of water. A common type of

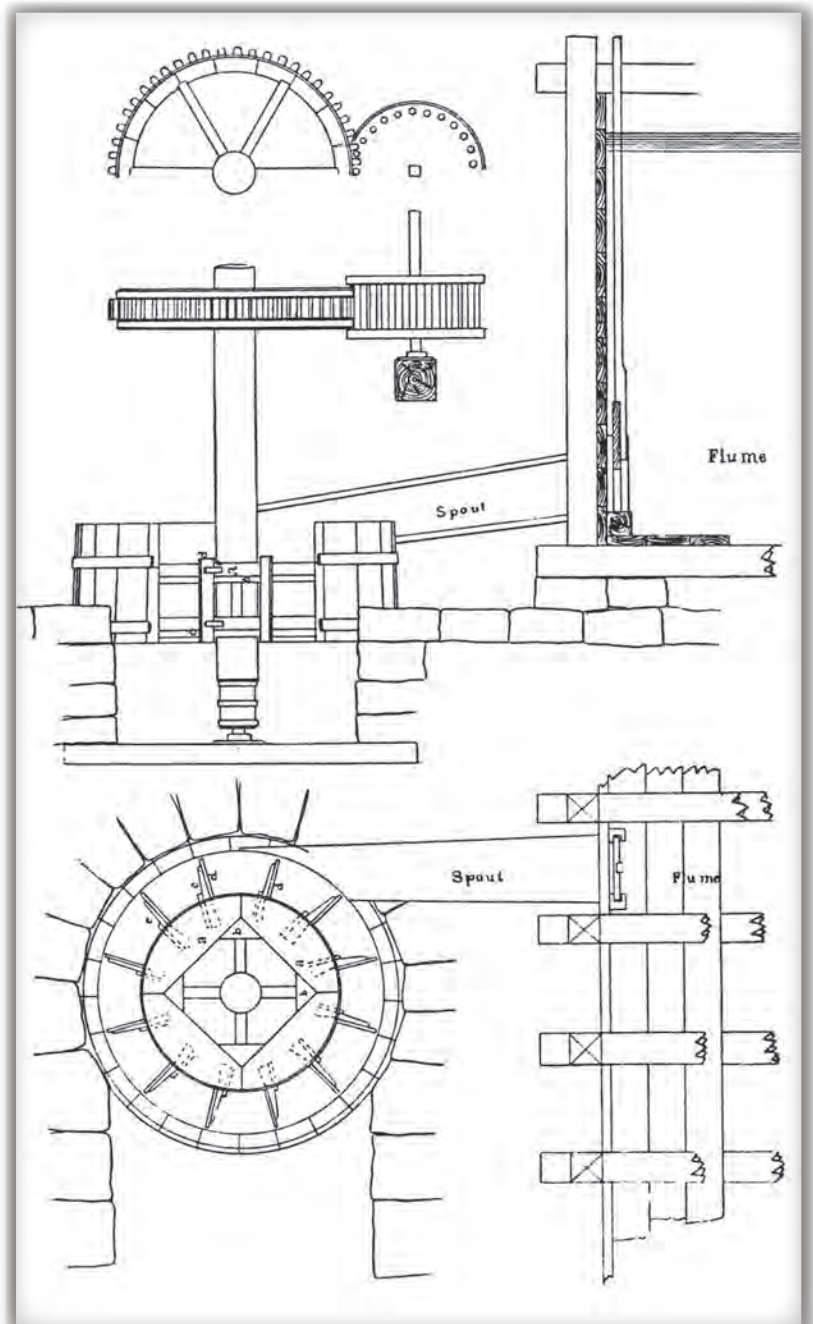

Profile and Plan  
of a Tub Wheel  
(Hunter 1979).



## Water-Powered Turbines

- A. Leffel's Improved Turbine, A Variation on the Francis Turbine (Leffel 1881).  
 B. Archaeological Remains of the Late Nineteenth to Early Twentieth-Century Turbine Pit Used at Eelbeck Mill (Site 9CE1734), Fort Benning, Chattahoochee County, Georgia (Cowie 2000).  
 C. Diagram Showing the Position of a Vertical Turbine in a Mill (Dedrick 1924).

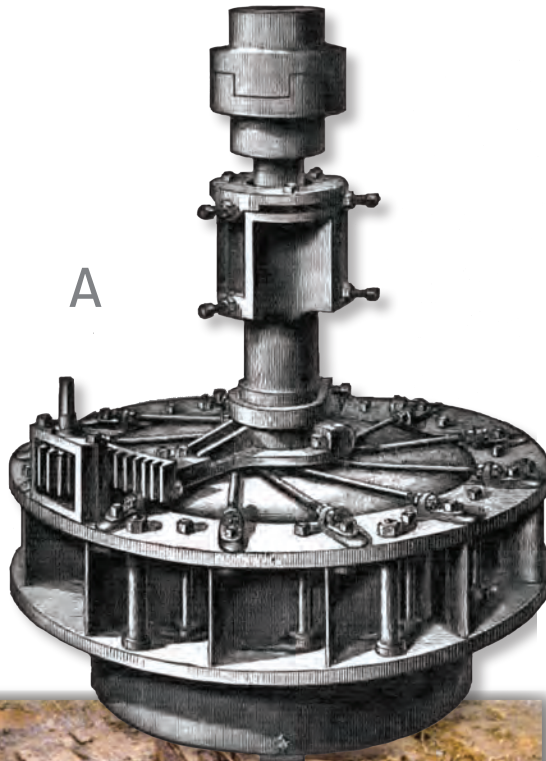

B

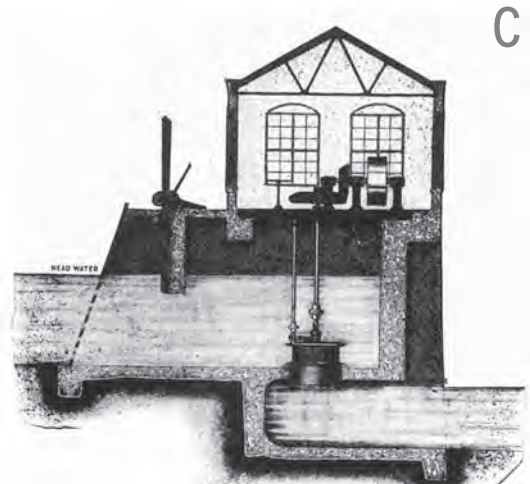
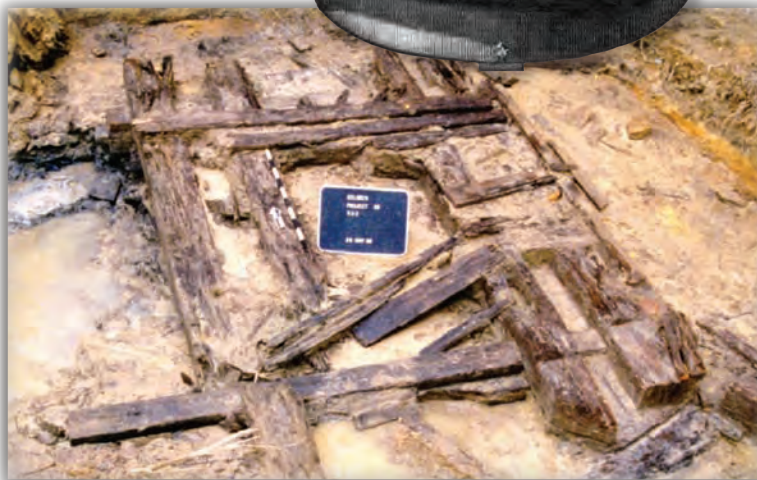

impulse turbine used in milling consisted of the scroll case, which was also called the snail or globe case turbine. In this type of system, the turbine blades or buckets were inside a circular case. Water entered through an opening at the outer edge of the case and flowed through a spiraling tube that decreased in diameter until it terminated at a nozzle. The decreasing diameter increased water pressure before releasing it on the blades. The water hitting the blades provided a constant stream of impulsive energy to the device (Woodford 2008).

Reaction turbines sit in a volume of water and turn as the fluid passes over them. As opposed to impulse turbines, which operate as the blades redirect the flow of the water, reaction turbines generate power by spinning as the water passes over the blades. Ideally the water remains in contact and pushing the blade

as long as possible (Woodford 2008). The Francis turbine, introduced in the 1840s, was an example of this type. These turbines contained a set of vanes on a rotating wheel (the “guide blades”) and a second set of blades (the “runner”) attached to the drive shaft. Both sets of blades were curved. The water first passed over the guide blades, which directed it down and outwards and against the runner. An advantage over conventional water wheels was that the water acted on all of the turbine blades at once, as opposed to the conventional type in which only some of the blades or floats were engaged at one time (Hunter 1979:321). This type of turbine became the most common used in American mills (Jeane 1974:30), and they were quickly adopted for gristmills and other industries with adequate river and stream flow (McVarish 2008:240).

Steam power represented an advancement of waterpower. As noted for sawmilling, however, steam technology did not come to rural districts quickly. It was expensive to acquire and maintain and not worth the financial outlay given the expected returns (Hunter 1979:508; Bishir et al. 1990). Eventually, however, small and portable steam plants were developed that could be used at rural mills. Steam power entailed forcing steam under high pressure into a cylinder through a series of valves. Inside the cylinder, the steam pushed a piston back and forth. A connecting rod converted the back-and-forth motion to a rotary motion that turned a large wheel (the flywheel). The flywheel thus formed the basis for operating machinery in the mill by connecting it to drive trains with a series of belts.

## THE MILL SEAT

Components of typical water-powered mill seats included the mill, the dam, and the millrace. These were arranged in ways intended to make efficient use of available water sources. Mills also had certain requirements with respect to topography and transportation routes. An ideal setting was level and rose slightly above the stream to avoid floods. If level ground was not available, the mill could be terraced into a valley wall. Access to transportation was critical as well because of the necessity of bringing in unprocessed raw materials and moving out the meal or sawn lumber.

Saw mills had the additional requirement of easy access to the resource (logs), especially as lumber production became more industrialized in the last part of the nineteenth century and mills became less reliant on waterpower. Because lumber had relatively high shipping costs with respect to its value and because unprocessed logs were more difficult to transport than milled lumber, sawmills were often placed closer to the forests than to distribution outlets (Compton 1916:4).

Often, natural landscape features met the mills' requirements for topography and transportation. Mills were typically located at shoals or rapids, which traditionally served as fording points. Thus, mill locations were sometimes associated with established travel routes. Alternatively, a milldam might be modified to serve as a bridge, and therefore draw the transportation to it.

Mill seats included a complex of buildings and structures. In addition to those related to the power train (the dam and/or reservoir, millrace, and mill itself), mill sites might include secondary facilities such as storage buildings, wagon yards, the miller's house, and others. Furthermore, the stream might supply power to more than one operation so that separate grist- and sawmills might lie near each other or be combined (Bryant 1922a:6; Jeane 1974).

For sawmills, these qualities applied mainly to small operations turning out custom work for local farmers. A larger commercial venture that used portable, semi-permanent, or smaller permanent mills had slightly different requirements, especially for storage. Logs had to be stored as they came from the forest, sometimes for lengthy periods to allow for seasoning, and then the milled lumber also required storage while it waited for shipment. Unlike gristmills, commercial sawmills generated profuse waste products that required storage until they could be disposed of. Semi-permanent sawmills had additional requirements. Because they were established for a moderate length of time in areas that might be remote from settlements, they might need housing and facilities to sustain workers (Bryant 1922a:6).

Jeane's Model of a Mill Complex Showing a Gristmill and Associated Settlement (Jeane 1974).

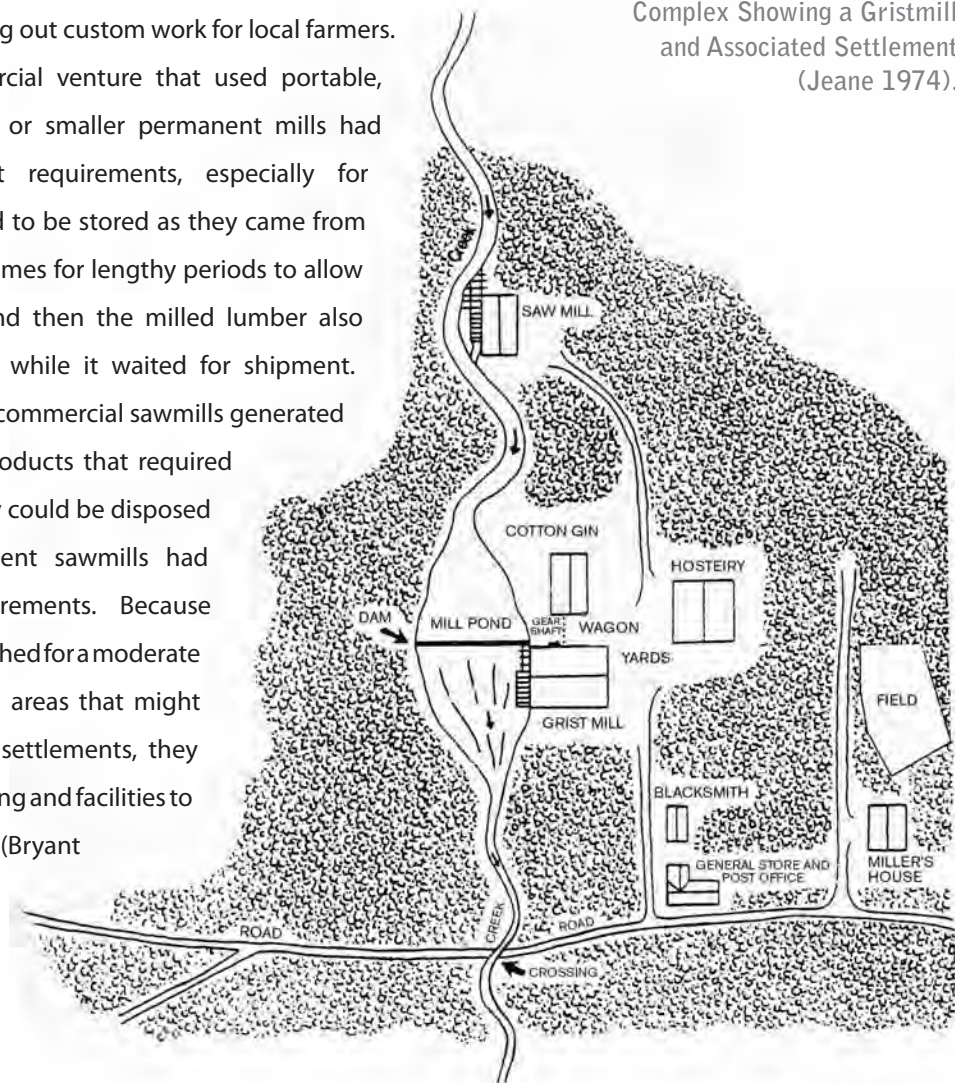



Activity and Land Use  
Associated with Sawmills

- A. Small Sawmill, Heard County, Georgia, 1940s, Showing the Sheds and Yards for Storage (Library of Congress).  
B. Sawmill Waste Products: Slabs and Sawdust. South Carolina, Date Unknown (courtesy of South Carolina Forestry Commission).



## MILL STUDIES AT SAND HILLS DOD INSTALLATIONS

A number of mill sites have been identified and studied at the six Sand Hills DOD installations. The most detailed of the prior research has taken place at Fort Gordon and Fort Benning. Mills have been recorded at the other installations but no studies beyond identification and evaluation have been conducted to date.

### FORT GORDON

The mill studies at Fort Gordon were the products of destructive flooding that breached several historic dams within the installation. Cultural resources investigations ahead of planned reconstruction or replacement of the dams provided opportunities to study aspects of milling and dam construction. Of 15 known mill/dam sites at Fort Gordon, nine were examined in detail (Lewis et al. 2009). The mills at the installation were small rural operations devoted to grain and/or lumber processing.

Braley and Froeschauer (1991), with Southeastern Archaeological Services (SAS), studied Boardman Mill (9RI430), situated on a tributary of Butlers Creek. Historical information indicated the mill seat here was initially developed in the 1770s, although it was modified over time before being demolished in the 1940s. This mill operated as both a grist- and sawmill, either simultaneously or alternately. Archaeological investigations revealed several features related to the operation. The principal feature was the dam, composed of a wooden frame in the streambed combined with earthen dikes on the adjacent valley walls. Braley and Froeschauer (1991:26) stated that only the central part of the dam was wood while the other sections were earth held in place by vertical planks or cribbing. The description implied that the wooden section of the dam did not extend into or underneath the earthen portions. The wooden portion of the dam was also described as being wedge-shaped, with the taper pointing upstream. Illustrations in the report, however, do not clearly show this construction.

Immediately downstream from the dam, Braley and Froeschauer (1991) identified a sandstone and brick wall they interpreted as the mill house foundation. Also downstream was the turbine mount, consisting of a brick and rock wall with a circular, metal-lined shaft. A remnant of a cement-block wall was associated with this feature, indicating a twentieth-century date or alterations. Upstream from the dam, a wooden deck of hand-hewn beams was interpreted as a support for the penstock or flume intake. A cement pad that partially overlay this platform was identified as a modern base for a spillway that replaced the flume after the Army dismantled the mill. Other features included two masonry pillars with metal brackets, identified as the supports for the original water wheel, which historic documents stated was 22 feet in diameter. These had been displaced and pushed downstream when the mill was demolished. Finally, a relatively unique feature (among the mill sites in this study) consisted of a dump pile of slabs cut from the outer circumference of logs. The dumpsite was on the bank of Boardman Pond, which later rose high enough to submerge the dump. Alternatively, the slab dump could reflect scraps from construction of the frame dam (Braley and Froeschauer 1991:10, 26-27).

The Boardman Mill exhibits certain attributes that were common to the mill sites at Fort Gordon. First, the mills used earthen levees to increase the pool level of the reservoir. Typically, the levees or dikes were built perpendicular to the stream for a desired distance. The stream was dammed with a structure of wood or later cement. None of the mill sites included lengthy headraces. Instead, the mills were set immediately downstream from the dam and the water was carried to the wheel or turbine in a short sluice or flume. Additionally, the mill remains exhibited episodes of repair and/or modernization. For instance, a turbine replaced the waterwheel, while cement and cement blocks replaced wood, stone, and brick for structural elements. Also, the rising pool level of Boardman Pond, indicated by the slab dump becoming

submerged, indicates the dam height was increased at some point. Several dams in the vicinity show this pattern of change and upgrades over time.

Wilkerson Lake Dam (9RI377), on McCoys Creek, comprised a second site investigated at Fort Gordon. Also studied by Braley (1994), historical sources suggested the site included a gristmill and electrical generator during the 1930s and 1940s. Backhoe and hand-excavation on the earthen dam did not identify any wood or masonry structural remains. Moreover, no evidence of the mill site or related features was identified. Archaeological and archival sources did not conclusively demonstrate the presence of a mill in this location.

Reed, Joseph, and Elliott (1994), of New South Associates, conducted surveys and investigations at seven mill sites on Sandy Run and Spirit creeks. Three mill sites were on Sandy Run Creek. Moving upstream, these were Union, Lower Leitner, and Leitner.

Union Mill (9RI453), consisting of a mill house, an earthen dam, and a brick and concrete raceway lay along the middle portion of Sandy Run Creek. Archival sources suggested a mill seat in this location by the 1860s. Archaeological investigations involved documenting exposed features but no substantial excavation took place. The principal feature of this site consisted of a dam and millrace, both of concrete, brick, and metal, and therefore reflecting twentieth-century changes to the original structure. Between 1916 and 1930, map data suggested that the millpond and race were substantially altered and the addition of cement structures might relate to this event. The dam consisted of a poured cement wall with buttresses on the downstream face. A lower portion of the dam wall at its east end was interpreted as a spillway. The site also included earth levees connecting to the poured cement dam abutments and extending onto the valley walls to create an impoundment. Evidence for the mill building and millwheel or turbine location were not clearly identified (Reed et al. 1994:63).

About a mile upstream, Lower Leitner Mill (9RI452) sat just below the confluence of Leitner Branch and Sandy Run Creek. The archaeological site was evaluated with a survey-level effort that identified an earth and concrete dam and a channelized segment of Sandy Run Creek that was interpreted as a tailrace. The dam was a cement and iron structure with a sluice gate at its west end and a cement walkway above it. The abutments were poured cement and brick, and tied into earthen levees that extended away from the creek to retain the pond. Downstream from the sluice, the cement abutment walls continued up to 93 feet south of the dam and for much of this distance cement slabs lined the bottom of the race to control erosion. The cement floor of the race was slightly lower (about 9.6 inches) than the sluice, indicating this

was the location of the wheel or turbine. No direct evidence of the mill was found and archival sources were not clear regarding its possible construction and demolition dates (Reed et al. 1994).

Reed et al. (1994) completed HAER documentation at Leitner Mill (9RI374), situated about 1.5 miles upstream from Lower Leitner Mill. This gristmill was in operation by the 1810s and might have been built during the late eighteenth century. It stood until the mid-twentieth century, and its appearance at that time was documented with photographs showing exterior and interior views. The archaeological remains included sections of a concrete dam with earthen levees and parts of a road and bridge that formerly crossed Sandy Run Creek at the dam. The extant remains indicated the earthen levee segments contained a wooden core. The dam was built from cement pillars. The spaces between the pillars were filled with poured cement walls that reached partway to the deck, creating a spillway. Portions of the dam were open at the foundation, having been closed with wood and metal gates, to allow the pond to be drained completely. The entire structure sat on a poured cement foundation. In its last years, the mill operated a turbine and an integral turbine pit of poured cement had been built on the upstream side of the mill.

Photographs taken in the 1940s provide further information about the mill's superstructure and layout. The photos show a frame structure with a two-story section containing a possible exterior belting conduit or grain elevator shaft. A shed addition was on one side of the building and a porch was on the front. As shown in the photographs, the top of the dam formed a wide walkway to access the sluice gates, while a shed straddled the upstream side of the dam turbine intake. An interior view showed the two main millstones emptying into meal troughs. A third grinder or possible sifter was behind the others.

Reed, Joseph, and Elliott's (1994) study also included four mills on Spirit Creek: Thomas Lake (9RI456), Maxwell (9RI455), Scout/Signal (9RI454), and Gordon. Thomas Lake lies on Middle Fork of Spirit Creek. Archival sources mention a mill that might have occupied this position in the nineteenth century, but in general did not point to a specific location of a mill and did not conclusively indicate one ever existed here. Archaeological survey identified scattered timbers that might represent the dam and/or a mill. These lacked integrity and so no additional research was conducted here (Reed et al. 1994:32).

Maxwell Mill, also known as Read's Mill, occupied a position on Marcum Branch, a tributary of Spirit Creek. Archival sources did not clearly indicate when the mill was constructed, but it was tentatively dated to the early part of the nineteenth century. Documentary sources indicated that Silas Read, the owner of the property in 1870, operated a sawmill. Archaeological evaluation (Reed et al. 1994) and subsequent HABS/HAER documentation by Panamerican Associates (Putnam 1995) recorded remnants of the mill

and dam. Like the other sites documented at Fort Gordon, the dam included earthen levees extending to the stream. A difference at this site was that rather than timber or cement, a structure of dry-laid granite faced with cement spanned the berms. The cement veneer represented a later addition, along with a cement retaining wall at the dam's east end where it tied into the levee. To the west, a stone wing wall was probably an earlier abutment. In the stream just below this wingwall, several vertical planks were interpreted as internal cribbing for an earthen dam at the base of the sawmill (Putnam 1995). It is worth noting that the stone portion of the dam was relatively narrow, being no more than three feet thick at the top, and probably was not watertight (Reed et al. 1994:79). Given this construction and the plank cribbing located downstream, it is possible that the stonework represented a core for an earthen dam. The base of the dam contained a channel that acted as a sluice and suggested the mill ran an undershot wheel (Putnam 1995).

Remains of the mill house were partly exposed in the west stream bank. This section consisted of a frame structure held together with mortise and tenon joints. Flooring and wall boards were nailed directly to the frame and sill timbers. The small section of the millhouse did not provide details about its size or internal organization (Putnam 1995).

Scout Mill, located on Scout or Signal Pond along McCoy's Creek, has an indeterminate history with regard to when or if a mill operated at this location. Historical documents do not indicate the presence of a millpond here until 1940, and do not specifically refer to a mill. Archaeological evidence, however, included well-preserved remains of wooden cribbing that suggested nineteenth-century construction typical of milldams. In this instance, the cribbing lay directly underneath the earthen dam and was exposed as a result of flooding. Exposed portions included wooden timbers in the streambed that were faced with vertical planks. Wooden wing walls on the north side of the structure tied into the stream bank/earthen levee. The exposed section of this dam did not provide enough information to determine how the mill operated. However, the all-wood construction and absence of cement, which was found at all other sites in this study, suggested the dam was built in the early part of the nineteenth century and abandoned before the twentieth century (Reed et al. 1994:86).

Finally, Gordon Mill lies on Spirit Creek and operated as a sawmill from at least the late nineteenth century to the 1940s. Archaeological remnants of this mill included scattered timbers and planks, with few being found in situ. The site lay partly within the right-of-way for U.S. Route 1, and prior road construction had probably disturbed the remains. Construction of a modern cement dam as part of the Fort Gordon Golf Course development also caused some damage. Extant fragments of the mill house indicated mortise



and tenon construction along with the use of wooden peg fasteners. The poor condition of the remains, however, did not provide extensive information about the mill's construction or operation (Reed et al. 1994:96).

## FORT BENNING

Fort Benning contains 11 recorded grist- or sawmill sites. Three (Eelbeck/Cooks Mill, Woodruff Mill, and Site 1RU424) have been subjects of archaeological evaluations and/or historical studies. A fourth site, 9ME757, was described as an antebellum steam-powered textile mill. Archaeological evidence, however, indicated the presence of a milldam and possible waterpower system.

Eelbeck was a historic community that grew up around a milling complex established sometime before 1836. This community was extensively documented with a historical and archaeological assessment (Smith 1992) as well as an oral history project (Kane and Keeton 2003). Additionally, a Phase II archaeological evaluation dealt specifically with the mill site (Cowie 2000). In the 1850s the gristmill came under the ownership of partners James Cook and Henry Eelbeck, the mill becoming known as "Cooks Mill" and the associated settlement as "Eelbeck." In the 1870s, the ownership began to change, first being passed on to family members and after 1910 it passed from the family to new owners. During the 1910s the business developed from a custom to merchant mill and became affiliated with two other mills under corporate ownership. The Eelbeck community essentially ceased to exist in the 1940s when the US government acquired the land associated with it and established Fort Benning (Smith 1992:26-29).

Information about Cook's Mill came from both archival and archaeological sources. Although its initial product—lumber or meal—was not definitively established, by the second half of the nineteenth century it was operating as a custom gristmill and was powered by tub wheels. In contrast to the mills at Fort Gordon, Cook's Mill drew water through a headrace that tapped Pine Knot Creek about 650 feet above the mill rather than from a pond located immediately adjacent to the mill house. Archaeological investigations indicated the presence of several structures representing the mill house, millrace, and dam as well as subsidiary features. A possible second mill was also identified that was located just downstream from the milldam.

Twentieth-century photographs provide further information about Cook's Mill and associated features. The mill house was a two- or two-and-a-half-story structure located on a terrace of Pine Knot Creek at the point where the headrace discharged into the stream. By the 1930s, it operated three sets of grindstones,

one being devoted to wheat, and was powered with a turbine (Smith 1992:36; Cowie 2000:122). Archaeological study of the millhouse identified concrete posts and columns that supported the building, and part of a concrete machinery mount. Test excavations exposed portions of the wooden turbine pit and flume sills. The turbine seat consisted of a box-shaped structure mounted on bedrock. The timbers were fastened with mortise and tenons and reinforced with milled lumber. Further excavation exposed beams leading to the turbine pit that were interpreted as the foundation of the flume. Associated artifacts found with these features included fragments of a millstone, pieces of canvas belting, an iron spout, and fragments of turbine blades and blade arms (Cowie 2000:139-142).

The millrace consisted of an unlined channel dug across a meander in Pine Knot Creek. No excavation of the feature was conducted to examine its construction. Two concrete wing walls at the upstream end of the race comprised the head gate remains (Cowie 2000).

At the point where the headrace opened to Pine Knot Creek, survey identified remnants of three separate structures spanning the stream (Smith 1992). The subsequent Phase II investigation added a fourth structure that had been mapped initially but not designated separately (Cowie 2000). The first three structures represented milldams. Visual inspection indicated they were frame dams built of hewn timbers with stone ballast. Archaeological excavations of a portion of one dam revealed it resembled a type known as a "tumbling dam," essentially a frame dam resting on piles. At least one of the other dams was also built atop vertical piles. The fourth structure consisted of submerged and possibly loose beams that could have washed downstream (Cowie 2000:112-119, 134). These structures lay within a few feet of one another and the most likely explanation for three dams being so close together is that they represent successive replacements, although Cowie (2000:119) suggests one might have been associated with another mill. Map data indicated that the millpond, labeled "Cook's Mill Pond" on topographic maps, was relatively narrow, essentially consisting of a widened segment of Pine Knot Creek. This suggests that the dam was a weir type, designed to raise the water level slightly but not to create a reservoir. In the case of this mill, the headrace created the desired fall.

It is important to note that while this discussion focuses on the mill at Eelbeck, the mill comprised only a part of a larger rural community. The mill site exhibited the most extensive and obvious array of archaeological features, but surface inspection of the mill area identified stone and concrete building foundations that might represent other industrial and commercial activities. Archival sources and informant interviews indicated that a store was once located near the mill, along with a cotton gin (part of or attached to the millhouse), and a blacksmith shop. Located at a greater distance from this industrial zone were several

residences and other businesses (Smith 1992; Cowie 2000; Kane and Keeton 2003). Although some of these structures have been identified and mapped by archaeologists, no intensive testing or excavation has been completed on any.

A second gristmill studied at Fort Benning is Site 9CE1735, which apparently dated to the turn of the twentieth century. Known as Woodruff Mill, this site lay less than a mile from Eelbeck on Sally Branch, a tributary of Pine Knot Creek. Inspection of the site identified several surface features including remains of the mill house, parts of a millwheel, a millrace, and a dam. The area of the mill house contained brick piers and remnants of milled wooden sills. A cement slab outside the building could reflect a porch or later addition to the main building, which measured only about 17x17 feet (Cowie 2000:88-90).

The millwheel at this site was found in situ just west of the millhouse and situated in the now-dry wheel pit. The wooden wheel measured just over nine feet in diameter and eight feet wide with an iron shaft connecting the two sides of the wheel as well as the gear wheel or master gear. The wheel exhibited a mix of traditional and modern (for the time) technology. For instance, building with wood was traditional, although metal versions (as well as turbines) could be had at the turn of the century. However, the spokes or arms of the wheel were not mortised to a central shaft, typically composed of a single log. Instead, iron plates were mounted on the metal shaft, essentially a pole, and the arms were fitted into sockets on the outside of the plates. Although the buckets were no longer present, the grooves into which they fit slanted back toward to the headrace, suggesting that the wheel was an overshot type. The wooden gear wheel also exhibited modern features. Rather than having teeth around its circumference to turn the mill's machinery, it possessed a pair of rims mounted at the ends of the spokes, the space between the rims being covered with thin wood sheeting. This configuration indicated that it acted as a flywheel, turning a belt rather than interlocking with a set of gears. Structural remains indicated that the wheel was mounted to cement wing walls. The wheel pit consisted of poured cement walls on three sides of the wheel (Cowie 2000:90-94).

This site also contained a headrace that extended from the millwheel for about 100 feet where it terminated at a rubble pile. A feature identified as a dam lay another 100 feet south of the rubble pile, indicating the headrace once extended further. The race consisted mostly of an earthen channel. Mortared sandstone and cement lining was noted along some portions, and appeared to reflect repair or maintenance episodes rather than a complete lining. Finally, the site contained remnants of an earthen dam. The portion of the dam at Sally Branch had eroded away, leaving only the earthen embankment of the millpond. Inspection of this feature identified brick and scrap metal in the fill. Its size and content suggested that it was built or

augmented by Fort Benning after the mill's abandonment. The same conclusion was reached regarding a concrete spillway at one end of the dam. This study did not determine if the milldam extended to the other side of the stream (Cowie 2000).

A third mill site examined at Fort Benning was 1RU424, representing a small gristmill located on a tributary of Uchee Creek in Russell County, Alabama. The site dated between the late nineteenth and early twentieth centuries and was represented by several features and artifacts indicative of a steam-powered gristmill. Structural remains noted here included a brick machine mount and a small mound of earth that appeared to cover a possible second brick machine mount. These features were footings for the boiler and engine. To one side of the earth mound was a circular pit that was interpreted as a well or reservoir for the boiler. Finally, two granite millstones lay on the ground surface in the same area as the other features (Cowie 2000:149-156). No remains of the mill house were identified and no evidence of a dam or pond was present, indicating a significant difference in the features associated with a steam-powered mill from those of water-powered mills.

Finally, Site 9ME757 reportedly was an antebellum textile mill that became the focus of a community known as Steam Factory. The community acquired a post office in 1851, suggesting that the mill had been established by that time. An initial survey of this site recorded several features, including a stone building foundation, an earthen dam, and three charcoal kilns. The subsequent Phase II work could not locate the charcoal kilns. The evaluation study, however, did find the stone building foundation, measuring approximately 200x55 feet, and a large deposit of brick rubble. A test unit in the brick rubble exposed a brick foundation, suggesting another building here. An additional feature of the site was an earthen dam that impounded two small drainages. The report stated that the dam was built of earth, but did not indicate if any sections were of other materials (Carruth et al. 2007:325, 331). Based on archaeological and archival sources, Carruth and her colleagues (2007:348-349) interpreted this site as a steam-powered textile mill established by Peter Guerry around 1849. Records indicate the factory became known as the Muscogee Steam Factory in 1851, and was involved with all aspects of producing cotton cloth. The excavators felt that the dam created a reservoir for powering the steam engine.

If Site 9ME757 represents a large commercial textile mill, then it stands out among the other mills discussed in this section for several reasons. Although this section is concerned primarily with water-powered grist- and sawmills, and specifically does not include commercial manufacturing mills, this site was included because it appears to contain features associated with waterpower and because of its rural location. Hunter (1975:172-173) stated that steam power was generally not available for industrial use in

the first part of the nineteenth century, except in cities, in locations where no waterpower was available, or where easy transportation made it possible to move the required and extremely heavy machinery. Water was the principal power source of manufacturing plants even in large industrial cities of the northeast. With this in mind, it seems unlikely that Guerry would have established a steam-powered factory in rural Georgia in the 1840s. Moreover, the presence of a dam at the site suggests that a waterpower system was in place. The question of how this mill operated, and what it produced, cannot be addressed here. Because of the lack of clarity regarding these issues, this site cannot be included in characterizing aspects of water-powered mills in the Fort Benning area.

## FORT JACKSON

Fort Jackson contains three recorded mill sites. Garners Mill (38RD536/620) represents a mill seat on Colonel Creek that predates 1820 and ceased operating by the end of the 1800s. Historical research conducted for this site did not determine if it was a grist- or sawmill (Clement et al. 2007:45-48). Phase II investigations documented several features including timber and earthen dam remnants, a possible spillway or overflow channel, and scattered timber fragments that might reflect structural and mechanical elements of the mill house. Although no longer present, historic maps indicated that a millpond formerly lay upstream from the dam (Roberts et al. 1992; Clement et al. 2007). The dam comprised the most substantial and recognizable feature at the site, consisting of an earthen levee extending south of the stream. The levee did not continue to the other side of the stream, but the pond here was retained by higher natural terrain. Remains of a timber frame dam lay in the stream. An additional feature included a ditch that extended around the projected location of the mill house, which was interpreted as a possible spillway. Downstream from the dam there were several loose planks and beams, as well as a gear shaft, consisting of a log with mortises cut into it (Clement et al. 2007).

A second site, 38RD498, was identified as a mill on the basis of millstone fragments and architectural debris at the head of a small Colonel's Creek tributary (Braley 1993). Phase II investigations identified evidence of burning, along with assorted hardware and plumbing equipment that suggested a late nineteenth- to twentieth-century date. Nails were the only direct evidence of a structure. No evidence of a milldam was found, although the plumbing hardware suggested steam power (Southerlin et al. 1995:55, 58-61). If this site is a mill, it further illustrates the different siting requirements for steam power. In this instance, the stream comprised a small, intermittent drainage with no clear signs of being impounded to provide a water supply. The site setting, moreover, was in the uplands near a drainage head.



The third site at Fort Jackson (38RD717) consisted of timbers located in Colonels Creek south of Messers Pond. The timbers were interpreted as possibly reflecting an early dam at this location, although extensive disturbance from a more recent dam, bridge, road, and spillway have eliminated traces of older features (Steen and Braley 1992:74).

## OTHER SAND HILLS DOD INSTALLATIONS

Of the other installations covered by this study, only Fort Bragg contains recorded grist- and sawmill sites. To this point they have been recorded only at the survey level and so little can be said regarding their construction or layout. Preliminary investigations, however, revealed that mill sites at Fort Bragg are in good condition and offer a strong potential for future study. For example, remains associated with Site 31HK1645\*\* include an earthen dam on Cabin Branch, wooden structural remains, and a depression on the adjacent stream bank that was interpreted as a saw mill pit. In addition, immediately adjacent to this site are two others (31HK1640/1640\*\* and 31HK1641\*\*) that represented a dwelling and possible office associated with the mill. Other dwellings are known to have existed in this vicinity as well (Steen 2006). The mill thus formed a part of a site complex that can be studied as a whole to better understand the social and economic contexts of milling in this region.

No mill sites have been recorded at Shaw Air Force Base or Robins Air Force Base. Given their locations and the area these installations contain, they almost certainly contain traces of nineteenth to twentieth-century saw and gristmilling that have yet to be discovered.

## SPATIAL PATTERNING

GIS data on historic mill sites was available for Fort Gordon, Fort Benning, and Fort Bragg. The research of mill sites completed at Fort Gordon suggested a model of site locations that could be tested in other parts of the Sand Hills (Reed et al. 1994).

Hunter (1979) provided a context for understanding the locations best suited for water-powered mill seats. He stated that mills had to be built adjacent to falls or rapids because changes in elevation concentrated at these locations. Ideal terrain was rolling and hilly, such as existed in the Sand Hills and Piedmont. In lowlands, such as the Coastal Plain, the streams were too wide and offered little fall. Mills here required long dams and these could cause excessive flooding upstream because of the limited relief. Sites in the mountains were constrained by steep slopes, which limited the volume of millponds, provided poor

access, and offered variable water flow. A mill seat also required areas that were level and protected from flooding the mill house, associated structures, yards, and other facilities, conditions that were harder to find in the mountains or low-lying Coastal Plain (Hunter 1979:121-122).

The Fort Gordon study revealed certain patterns in mill locations. They were closely spaced, typically within one to two miles apart, and numerous mill seats lay along the same valley. The data suggested mill locations coincided with two physical landscape features. First, sites were usually a short distance downstream from stream confluences to provide the millpond with multiple feeders. Second, sites were at naturally occurring narrow points in the valley, and so required shorter dams (Reed et al. 1994:177-178). Maps showing mill sites at Fort Gordon, like the one above, show this clearly. In addition, highlighting the slope of the valley walls revealed that the mill sites lay at transition points where the valleys became both narrower and more vertical. The area just upstream was wider and less steep, allowing for greater pond volume. The millwrights in the Fort Gordon vicinity thus used the narrow parts of the valleys as natural walls for the dam and reservoir, using wood and cement structures to fill the gap between valley walls. This design also had economic benefits as it permitted a minimum investment in timber framing or cement construction. In every example seen at Fort Gordon, the valley walls on the downstream side of the millpond were augmented with embankments to raise the pool elevations.

To test this model's usefulness in predicting mill site locations, data from Fort Bragg and Fort Benning were examined. The GIS analysis indicated that at Fort Bragg, the mills showed a pattern similar to Fort Gordon. Two mill sites selected as examples were both downstream from confluences. One of these was located on a second-order stream at a point where the topographic data suggest a drop in elevation, making it an ideal site for a mill. A difference here, however, is that the terrain as shown on the topographic map did not indicate a natural constriction. Instead, one valley wall was only moderately sloped, which would require a more extensive dam to develop a millpond. The second site, located downstream from the first, sat on a larger stream and, as predicted by the model, lay at a narrow section of the valley. It is worth noting that overall, the terrain at Fort Bragg was smoother than at Fort Gordon and valley walls were less steep. This difference might have implications for accurately predicting mill locations.

At Fort Benning, mill sites mostly followed the model, being located downstream from confluences and at narrow points in valleys. Three mill sites in the northeastern portion of the installation illustrate this. Site 9CE1734 lay downstream from a confluence of Mill Creek and a tributary, the dam forming Kings Mill Pond. This site did not take advantage of the best available location for a mill seat in this valley, a potentially better one being just downstream where the valley narrowed and the walls on both sites

became steeper. However, influences not visible on the topographic maps, such as the position of a fall or historic property boundaries, might have affected the mill's location. Immediately south of this mill, Site 9CE1603 lay on a feeder to Kings Mill Pond just below a confluence with a first-order drainage. This site was very close to the first one, which is unusual. More typically, closely spaced mills lay on the same watercourse. Site inventory data for this second site, however, described the site as a historic mill dam but does not indicate the presence of a mill house, leaving open the possibility that the dam here was intended for water management rather than power. Finally, Site 9CE2133 fit the model very neatly, sitting at a constricted portion of a valley just downstream from confluence. Moreover, the dam lay at a point where the valley walls were quite steep, while above the dam, the valley not only became wider but the eastern walls sloped less, which provided additional volume for the pond.

Sites 9CE1734 (Cook/Eelbeck Mill) and 9CE1735 (Woodruff Mill) at Fort Benning showed divergence from the model and used the landscape in different ways than other mills discussed thus far. These two mills occupied relatively wide valleys and achieved desired fall with headraces rather than impoundments. These variations could reflect one or more influences. The millwright might have preferred the technique of using a headrace rather than building a pond. Alternatively, upstream landowners might have objected to construction of a reservoir that would flood bottomlands and low terraces. Finally, having to work with the land they had, the mill owners might have used the headraces because it was the most efficient option available.

In sum, analysis of mill site locations indicated they mostly occur within a few hundred meters downstream from confluences and at locations where the valley walls form natural constrictions. The valleys also commonly had lower slopes upstream from the dam location. There were exceptions to this model, however, indicating the model would require additional data and refinements to improve its reliability. Additionally, the North Carolina portion of the study area showed more moderate relief, which might affect the application of the model there.

The study of mill distributions thus indicates that they fall in mostly regular and predictable locations. However, their locations will also reflect aspects of local terrain, land ownership, the negotiation of water privilege use, and possibly other influences. Predicting water-powered mill locations, therefore, can best be done by combining archival sources, which point to possible locations of sites, and consideration of the physical factors that affect where mills are most likely to be built.

## RESEARCH RESULTS AND DIRECTIONS FOR FURTHER STUDY

Consideration of the recorded mill sites at the DOD installations included in this study indicated certain patterns in location, technology, land use, and other variables, as well as suggesting possible avenues to guide further research of rural mills in the Sand Hills. The development of research questions is an important step in evaluating the archaeological and historical significance of sites (and thus their NRHP eligibility), and therefore provides the basis for effectively managing them.

Because it took in several sites in a single study, Reed, Joseph, and Elliott's (1994) investigation of mill sites on Sandy Run and Spirit creeks at Fort Gordon provides an excellent starting point for looking at patterns in the data and establishing important research topics. The study revealed a number of similarities with respect to water management, dam construction, and setting, although certain variations were also noted. The physical landscape features associated with mill locations at Fort Gordon were noted above: mills were located at constricted points of stream valleys and all occurred at or immediately below stream confluences. The mills in this study were closely spaced, typically within one to two miles apart, and numerous mill seats lay along the same streams. Historic maps indicated that in 1908 five mills were located within five miles of Leitner Mill. Close proximity was apparently a cultural norm dictating that mills provide service to relatively constricted areas for the benefit of local farmers. The mills at Fort Gordon, however, appeared closer than was considered typical. Another study of mill distributions in Georgia indicated that a mill's service area was usually around 20 miles in diameter (Thompson 1953). The smaller service areas of Fort Gordon area mills might be due to their emphasis on lumber over grain. Reed, Joseph, and Elliott (1994) found that all of the Fort Gordon mills were initially established as sawmills during the late eighteenth to the early nineteenth centuries. Because these mills were focused on providing building materials to Augusta, they did not need to space themselves to accommodate a sparsely dispersed farming population. Instead, they were spaced to handle a resource that was common and widely distributed (Reed et al. 1994:177-179).

They also shared other attributes in their arrangements. For example, they all utilized millponds to cache water for use during operating hours and did not use headraces. Instead, they utilized levees or embankments extending across the valley walls from the dams to achieve higher pool levels. Dam construction was another common attribute of the mills in this study. The stream valleys between the embankments were spanned with dams of wood or poured cement. Although Leffel (1881) describes several types of dam that might have been used in the Fort Gordon area, archaeological investigations have suggested that the most likely types used here included hollow-frame dams or the "Safe and



Economical Dam” (Braley and Froeschauer 1991; Reed et al. 1994). The use of poured cement reflects a switch in the twentieth century to a material that was economical, durable, and widely available (Reed et al. 1994:184).

Waterpower equipment was also considered for the Fort Gordon mill study. Although in most instances, the type of waterwheel used at a particular mill was not determined, archival sources combined with archaeological data provide some information about this topic. Prior to the common availability of turbines in the later nineteenth century, all of the mills at Fort Gordon would have used a waterwheel. Census data for 1880 indicates that throughout Richmond and Columbia counties, although turbines were the most common, six mills at this time operated tub wheels. In this same year, the census indicated no undershot or overshot wheels in the two counties and only one breast wheel. While some mills continued to operate older types of equipment, most (n=15) ran turbines, indicating that area millers had largely made the switch to newer systems (Reed et al. 1994). Based on archival and archaeological sources, Reed, Joseph, and Elliott (1994:202) concluded that the switch to newer technology was not a systematic process of constantly experimenting with and upgrading production. Rather, they believed that these improvements came during rebuilding episodes following natural disasters, such as floods that severely damaged the older equipment.

Expanding the view from Fort Gordon to include the other installations, one difference that became immediately apparent was that some mills documented at Fort Benning used a different dam and millrace arrangement than the ones seen at Fort Gordon, Fort Bragg, and Fort Jackson. At Fort Jackson and Fort Bragg, documented mill sites included dikes across the stream with a central structure of wood. At Fort Gordon, poured cement was also used in more recent dams. At Fort Benning, however, the mill at Eelbeck used a weir-type dam to raise the level of the stream and then increased the fall with a lengthy headrace. A second mill (Woodruff’s) also used a headrace. An earthen dike was noted at this site, although it was not clearly associated with the historic mill. An initial topic for further research, therefore, is to categorize milldam types in the Sand Hills, examine their distributions, and consider what influences affected their use.

A second topic addresses the types of equipment used by mills in other Sand Hills locations. At Fort Gordon, turbines were common, although in the broader region, tubmills remained in use as late as 1880 while other waterwheel types were not. Of three mills recorded at Fort Benning, one operated a turbine during the early twentieth century, one used an overshot wheel around the turn of the twentieth century, and the third had a steam engine around the same time (Cowie 2000). The overall data sample is too

small to identify patterns here. Therefore, additional archaeological and archival research is necessary to determine the types of power sources in use throughout the Sand Hills, and then to look for patterns that might have been present.

Another topic deals with the locations of mill sites. At Fort Gordon, mills seemed to lie at natural constrictions in stream valleys, and the topographic map associated with Garners Mill on Fort Jackson seems to show a similar placement (Clement et al. 2007). It is not clear if the mills at the other installations were also sited this way. Additionally, it would be important to examine the average distances between mills and determine if they are consistent or significantly different in different parts of the Sand Hills. At Fort Gordon, the explanation for the atypically close spacing of mills was that they were supplying lumber to a growing city rather than processing grain to a dispersed farming population (Reed et al. 1994). Therefore, what is the average spacing of mills at other regions and do their distributions appear to relate to nearby urban centers or other influences?

A further issue that is worth addressing deals with the management of water for mill use within a particular drainage system or geographic area. A study by Gradie and Poirer (1991) of New England mill sites found correlations between water management techniques, size of the milling operation, and certain environmental characteristics. In the Sand Hills, it would be worthwhile to look at how millers utilized different drainage basins and water resources. For example, if a particular drainage lacked sufficient capacity to operate a mill continuously, secondary upstream impoundments could be created to help refresh the millpond (Gradie and Poirer 1991:59). At Fort Gordon, at least two of the dams (Wilkerson and Signal/Scout) on McCoys Creek, a tributary of Spirit Creek, did not yield conclusive evidence of a mill, suggesting they could have functioned to store water to replenish downstream ponds.

Finally, the relationship between the mill sites and other industrial and non-industrial sites needs to be addressed. The mill sites identified at the DOD installations show variation, with Eelbeck at Fort Benning being at the center of a settled community, while others, such as the mills at Fort Gordon and Garner's Mill at Fort Jackson appearing to be located in relative isolation. In a middle position, Site 31HK1645\*\* at Fort Bragg is associated with a few domestic sites but not the same kind of community that included assorted industrial, commercial, and residential activities as Eelbeck. This issue might require investigations into the nature of settlement in different regions. It seems to indicate, however, that the milling in the Sand Hills did not follow a single trajectory of settlement and land use based on its unique environmental characteristics.





## FOREST PRODUCTS— NAVAL STORES AND LOGGING

### NAVAL STORES — “THE RESINOUS PRODUCT OF PINE”

Naval stores encompass various products made from pine forest resources. Tar and pitch, a refined tar product, mainly had applications for nautical purposes as preservatives and sealants, although they were used for a variety of other functions as well. Turpentine and rosin had little economic significance until after 1800. Spirits of turpentine emerged as a common lamp fuel and an important solvent in the rubber industry. It was also used in the manufacture of various products while rosin was put to use in various other manufactures. The demand for these products led to expansion of the naval store industry in the southeast throughout the nineteenth and early twentieth centuries (Outland 2004:6). These industries were particularly significant to the Sand Hills because they relied on the exploitation of pine trees, the dominant forest cover of the region. Also, together with lumber, naval stores comprised one of the largest industrial economies of the Southeast.

Included in the following discussion is charcoal. Although not specifically applied to the naval stores industry, charcoal production shared many attributes with tar manufacturing and sometimes comprised a by-product of tar. The application of charcoal was mainly to the iron industries that emerged in the Valley and Ridge region.

### TAR AND CHARCOAL

Tar production was an early and important industry in the southeast. Extensive pine forests and access to navigable rivers and coastal ports combined to make in the southeastern Coastal Plain and Sand Hills into one of the world’s most significant naval stores regions (Spangler 1921:41-42). It remained prominent in the regional economy from the colonial period through the early twentieth century (Abbott et al. 1995:51), although the production process as described below did not change substantially until modern methods became widely available during the twentieth century.



Tar came from smoldering pine logs in earth-covered kilns. Making pitch involved extra steps to refine the basic product. Tar-making was done in the winter or at odd times between other seasonal tasks (Greeley et al. 1873:983). Seasoned pine constituted the optimal raw material for tar, and in the south longleaf pine was the main source. Sections of forest were clear-cut well in advance of burning to allow the wood time to season. The wood was later cut and split for stacking in the kilns. The trees used for tar and pitch might include exhausted turpentine trees (see below) (Harmon and Snedeker 1993:102-104). After repeated harvesting, the raw turpentine gum oxidized near the scarred surfaces and changed the nature of the wood, making it highly flammable, but also infused with sap considered no good for turpentine but suitable for tar (Greeley 1873:982-983).

To build a kiln, tar makers cleared their site and excavated a shallow circular or rectangular depression 15 to 25 feet in diameter. Next, a trench was dug from the center of the depression to the outer edge, to drain the tar as it seeped from the wood and take it to the outside of the kiln for collection. Pipes could also be used for this purpose. At the outflow point of the drain, a hole or trench was dug to about six feet deep to collect the tar, from which it would be dipped out and into barrels (Harmon and Snedeker 1993:104).

## FLATLAND TAR KILN

Cross Section of a Tar Kiln Showing Typical Components (Harmon and Snedeker 1993).

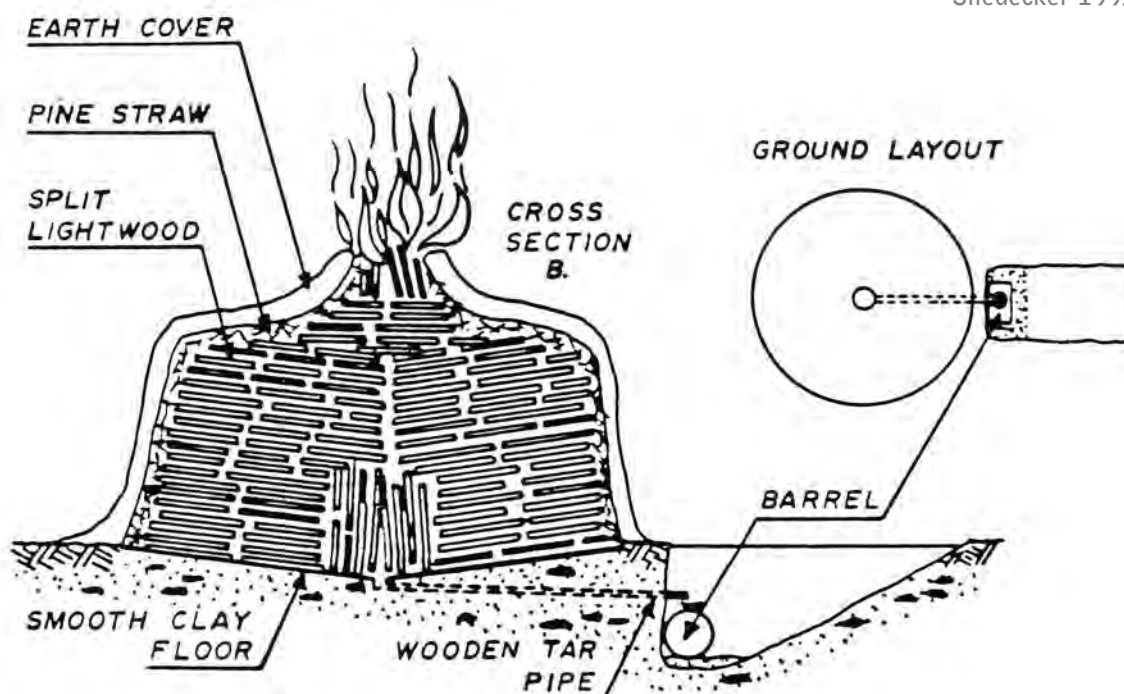



#### TAR KILN CONSTRUCTION

A. Wood Being Stacked for a Tar Kiln.  
Chesterfield County, South Carolina, Date  
Unknown (courtesy of South Carolina Forestry  
Commission).

B. Logs Stacked and Ready to be Covered in  
Turf. Location and Date Unknown (courtesy of  
Fort Bragg Department of Public Works).

The kiln was built by stacking the wood in a circular or octagonal shape up to 30 feet in diameter and 10 to 15 feet high. Kilns typically contained 12 to 15 cords of wood and were described as looking like haystacks (Harmon and Snedeker 1993). The tar makers threw stumps and scrap wood into the center of the kiln, which







A

B

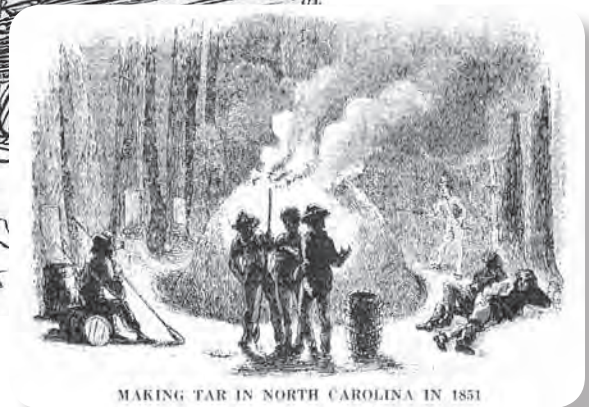

MAKING TAR IN NORTH CAROLINA IN 1851

### FIRING A TAR KILN

A. Small Shelter Used by Workers Monitoring a Kiln, 1800s (courtesy of Fort Bragg Department of Public Works).

B. After Covering with Turf and Ignition, mid 1800s (courtesy of Fort Bragg Department of Public Works).

helped fuel the burn. The kiln was covered in turf and earth to dampen the fire and maintain the low heat necessary to release the tar without incinerating the wood. The burning process continued for several days to several weeks, during which time the kiln had to be managed constantly (Spangler 1921:42; Bizzell 1983:165).

As the kiln heated up the wood began releasing the tar, which ran into the deep collection trench outside the kiln. From here, the tar was dipped out of the trench and into barrels to be transported out of the forest. When the tar stopped flowing, the kiln would be sealed to let the wood smolder and produce charcoal. After firing, the kiln would be dismantled and the charcoal collected for other uses.

A



B

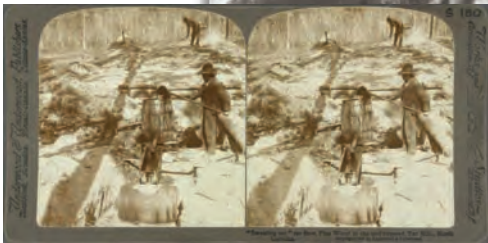

### TAR COLLECTING

A. Detail of Tar Accumulated in a Kiln's Collection Pit, South Carolina, 1900s. (courtesy of South Carolina Forestry Commission).

B. Dipping the Tar from the Collection Trench. In this instance, the worker poured the tar into an upright barrel that then drained into a second barrel. North Carolina, Date Unknown (NY Public Library).

Components of a tar-making operation included the kilns themselves and associated activity areas. The related areas would not necessarily produce extensive archaeological materials, however. Although the tar makers camped at the locations where the work took place, the process did not involve permanent structures and facilities. Kilns were used only once, and the process was carried out at a distance from settled areas and not in regular or reused locations (Spangler 1921:42). Therefore, it did not give rise to long-term, intensive occupations or related infrastructure like other industries did. Surveys of tar kiln locations at Fort Bragg in North Carolina confirm these suggestions, as very little material culture was recovered from the vicinity of the kilns (Gray and McNutt 2004).



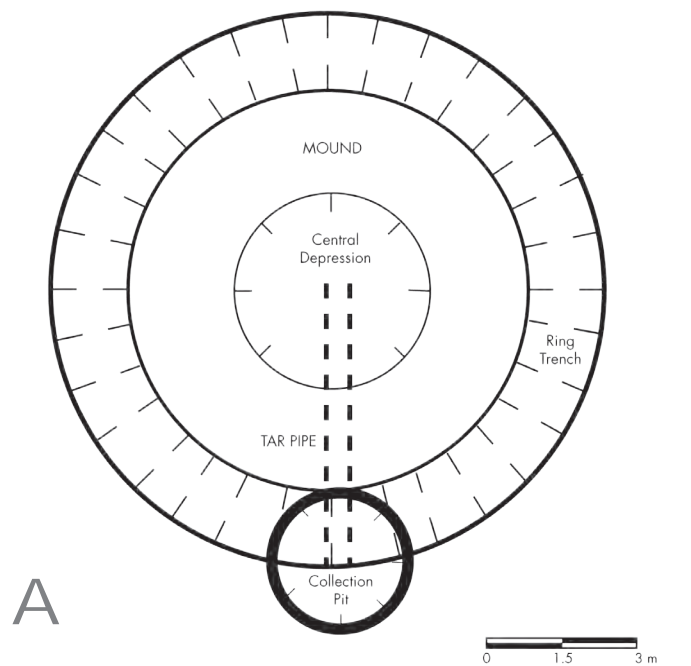

A

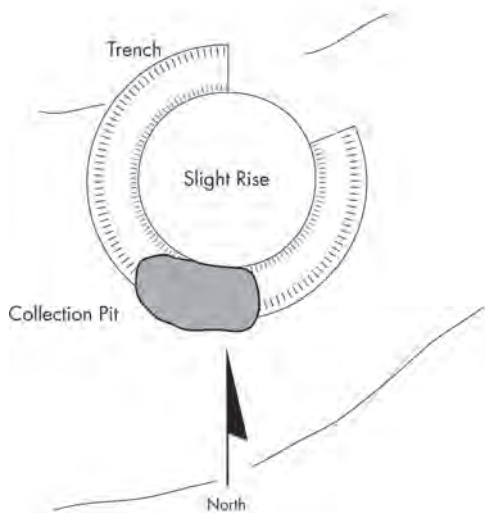

B

ARCHAEOLOGICAL REMAINS OF TAR KILNS

A. Typical Archaeological Remains of a Tar Kiln (Harmon and Snedecker 1993).

B. Round Tar Kiln (Site 31HT928) at Fort Bragg, Harnett County, North Carolina (Gray and McNutt 2004).

C. Rectangular Tar Kiln (Site 31HT929), at Fort Bragg, Harnett County, North Carolina (Gray and McNutt 2004).

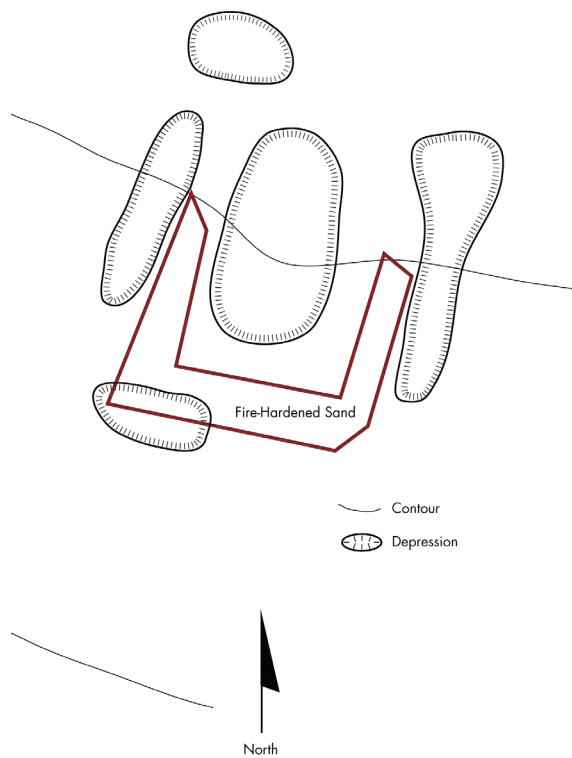

C

Harmon and Snedeker (1993:108-113) generalized about the locations of tar kilns and the character of archaeological sites associated with them. Kiln remains typically consisted of raised mounds with central depressions encircled by a shallow ditch or "ring trench." The purpose of this trench is not understood, although Harmon and Snedeker (1993:112) suggested that they reflect the borrow pit for the soil used to cover the kiln during burning. A deeper pit or trough representing the tar collection pit should be present at one edge of the feature, most likely on its down-slope side. Metal drainpipes might also be present leading to this pit. Few other artifacts or structures have been found in association with these features. Kiln locations mostly occupied low ridges and knolls; placing them on a slope would help the tar flow to the collection pit (Spangler 1921:42). Often they were placed near seasonal drainages. Also, Harmon and Snedeker found kilns often occur in proximity to one another, presumably because crews worked on specific tracts of forest at one time before moving on to another location. Although these features are usually round or oval shaped, examples from the 1920s and later might be rectangular (see Tar 5) (Harmon and Snedeker 1993:121).

Pitch was a refined and less caustic tar product made by boiling tar in iron kettles or in-ground pits until it lost about one-third of its weight (Mohr 1897:68). The boiling pits varied in size, with different sources from the eighteenth century suggesting diameters between four to six feet and depths of three to six feet. The pits were lined with clay if the natural soils were too porous (Harmon and Snedeker 1993:105).

As noted, charcoal could be made as a by-product of tar manufacturing. In the Sand Hills this might have been the norm because the pine forests were best suited for tar production. Burning trees explicitly for charcoal without collecting the tar would have wasted a valuable commodity. Also, charcoal was used mainly for the iron industry, which was situated in the Ridge and Valley, and therefore the market for charcoal was more distant and not as accessible as the river and coastal ports that tar products were destined for.

Kilns devoted solely to charcoal production were built similarly to those for tar, but eliminated the drainage trench and collection pit. Given the similarity in raw material and fuel, charcoal operations probably had similar distributions to tar kilns in terms of being situated in relatively isolated locations.

## TURPENTINE AND ROSIN

Turpentine production was significant in the southeast from the Colonial era to the twentieth century and particularly during the nineteenth and first part of the twentieth centuries. The regional focus of the

turpentine industry moved south and west as pine forests were exhausted in one region after another (Abbott et al. 1995).

Unlike pine tar and pitch production, which entailed the “destructive distillation of the wood” (Mohr 1897:68), turpentine production involved collecting crude turpentine from living pine trees and distilling it into a refined material. The same trees could be harvested for several years before becoming exhausted. Specific tasks essentially included harvesting and processing/refining. Rosin was a by-product of turpentine manufacture, being the residue remaining after distillation.



Cutting a Box in a Living Pine Tree, Georgia, 1903 (U.S. Forest Service).

Next, the bark was scarred or removed from the face of the tree above the box to encourage gum to flow, a process known as “chipping” or “hacking”. A special tool, the “hack” was used for this purpose and consisted of a curved blade attached to a handle with an iron counterweight at its opposite end (Mohr 1897:69). The cuts were freshened frequently and new ones were added throughout the summer and fall, moving up the

Turpentine production began with the collection of the crude turpentine or gum. The ideal time to begin work was in the spring when sap began to flow. Workers first cut cavities called “boxes” or “chop boxes” near the bases of the trees. Typically eight to 12 inches above the ground and seven inches deep, they were cut downward into the tree’s face at an angle. A single tree could have more than one box, but they were never deep enough to cut into the tree’s heart. Each box could hold one to two quarts of gum (Mohr 1897:69; Outland 2004:68). The cutting process required a degree of skill and experience to ensure that the tree was not severely injured while at the same time maintaining a brisk work pace.

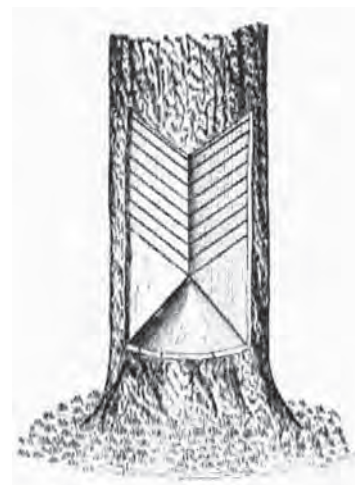
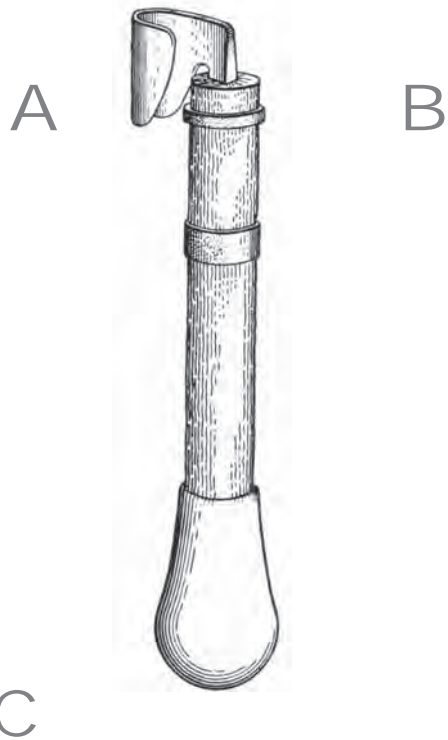

Diagram of Turpentine Box and Cuts Made to Encourage Gum to Flow (Bryant 1917).



### HACKING

A. A "Hack" Used to Scar Turpentine Trees (Gamble 1928)

B. Sharpening the Cutting Blade of a Hack (U.S. Forest Service)

C. Using a Hack to Scarify a Turpentine Tree. This twentieth-century photograph shows the process being used with a metal collecting cup instead of a box cut into the tree. Unknown Location (U.S. Forest Service).





trunk. Like cutting the boxes, hacking was a skilled occupation. It was important that cuts were not so deep that the tree's health was compromised. Also, if the cuts were too broad, the face would become too high for the tree to be harvested (Outland 2004:73). Hacking caused the gum to ooze down the face into the box. This raw material was dipped out and into buckets, and later transferred to barrels for shipping to the distillery. The tool used to dip the raw turpentine consisted of a flat trowel-shaped implement. When cool weather arrived in the fall, the gum stopped flowing and began to dry. At this point, the hardened gum was chipped from the scarified tree face and the box with special tools including a spatula-shaped blade mounted on a wooden pole (the "pusher") and a curved blade on a pole (the "puller") (Mohr 1897:70). Workers performing this task also used special containers, consisting of boxes with wheels or struts that they propped against the tree to collect the dried gum.

Dipping Raw Turpentine from Boxes (courtesy of Fort Bragg, Department of Public Works).



Scraping Hardened  
Gum from the Cut  
Face at the End of  
the Season. Unknown  
Date and Location  
(U.S. Forest Service)



By the late nineteenth century, techniques for harvesting the crude turpentine were introduced that were less injurious to the trees. These included replacing the box with containers that could be nailed to the tree. "Herty cups" were ceramic or terracotta vessels about the size and shape of flowerpots, with a hole near the rim to hang it on the tree. V-shaped cuts made into the tree directed the raw turpentine toward the pot, while wedges or flat strips of metal or wood driven into the tree at angles, helped funnel



the gum to the cup. Later, cups and trays made from folded metal sheets were introduced to compete with the ceramic cups. An advantage of the new system over the older box method was that the cup could be moved up toward fresh cuts, thus decreasing the distance the gum had to travel down the face of the tree and reducing its exposure to air (Mohr 1897:71). Despite yielding cleaner and better quality material, this method was more expensive to set up and operate. It never gained widespread acceptance and cut boxes persisted well into the twentieth century (Outland 2004:213-215).



#### IMPROVED COLLECTION METHODS

A. Turpentine Trees Equipped with Ceramic Herty Cups to Collect Raw Turpentine (courtesy of Fort Bragg Department of Public Works).

B. Close-up of Gutters and Cups for Turpentine Collection (U.S. Forest Service).



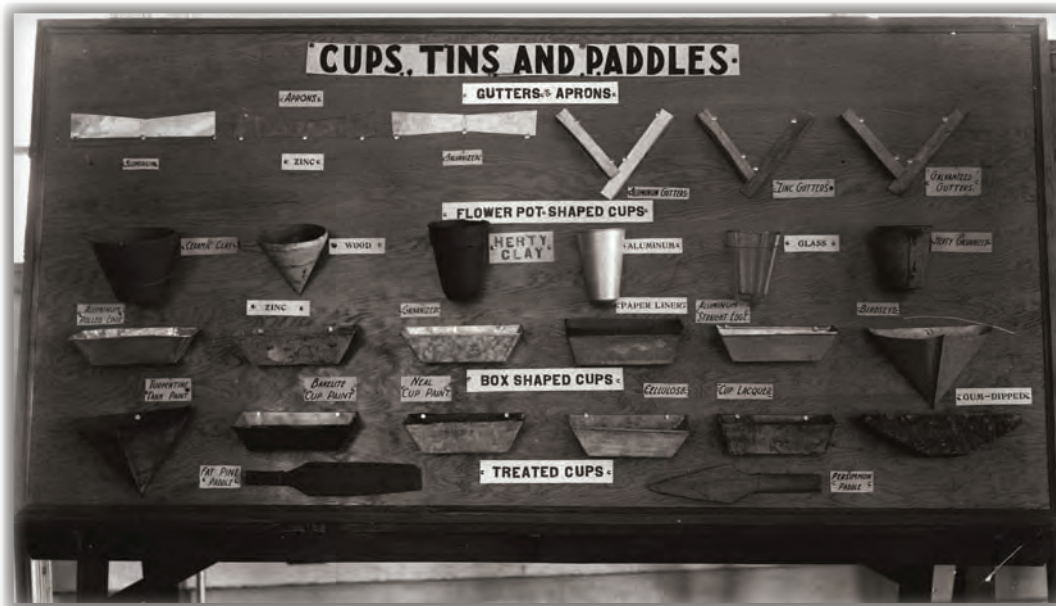

Cups, Gutters, and Dippers ("Paddles") Used for Turpentine Collection (U.S. Forest Service).

Turpentine manufacturers employed specialized terminology to refer to the various products and qualities generated by the chipping. The raw turpentine was referred to as "dip" and the hardened sap gathered at the end of the season as "scrape" (Mohr 1897:70). The first crop of gum that a tree yielded was "virgin dip" and produced the highest quality rosin, described as "limpid as honey and of a pale straw-color; exposure to the air soon causes it to grow opaque and creamy" (Greeley et al. 1873:978). Sap produced the second year was known as "yellow dip," and each successive year the sap was darker, thicker, and contained less volatile oil (Mohr 1897:67). By the end of the 1800s, four years was the maximum time a tree remained in use by larger turpentine manufacturers because of decreasing returns compared to the costs of harvesting. Small landowners, however, might continue to harvest trees for 10 years or more, often giving the trees a rest for a few years (Mohr 1897:70). Prior to the Civil War, planters making turpentine might be able to carry on longer because the cost of labor was lower and any initial capital outlay was repaid during the initial years of operation.

Distillation was the second stage in producing turpentine. The raw turpentine was barreled at the orchard (the term applied to the stand of trees being harvested) and taken to a distillery. The distillery typically consisted of a two-story structure, the upper floor containing the still and associated activity areas while the furnace





for heating the still was on the ground floor along with vats for the rosin. Distilleries were often located at streams, which provided the water necessary to cool the condensing tube. Locating the facilities on a larger watercourse also provided transportation (Mohr 1897:69; Abbott et al. 1995:54). After the Civil War, railroads became involved in shipping naval stores and actively solicited distilleries to set up along the rail lines (Outland 2004:134). Wells also supplied water for distilleries, and combined with railroad service, freed the distillery from the requirement for a surface water source.

Collecting the Crude Turpentine in the Orchard (U.S. Forest Service).



Typical Rural Turpentine Distillery Showing the Still on the Upper Floor and Furnace Below. Northwest Florida, circa 1910 (Florida State Library).





Activities Associated  
With Turpentine  
Distilling (courtesy  
of Fort Bragg  
Department of  
Public Works).

The process of distilling turpentine involved several steps. Separating and condensing the spirits of turpentine from the crude raw material was one phase of the process, while preparation of the rosin was another. A nineteenth-century lithograph illustrated the different activities of a distillery. The main distilling activities took place in a central, open-sided wood-frame structure that housed the still and furnace. To the right, an enormous wooden tank contained the coil for condensing the steam. The tank was filled with cold well water from the tower at its right, and the resulting product exited the coil at the base

of the tank, shown taking place under a shed roof. In a second shed to the left of the distillery, rosin was drawn off from the still via a trough and deposited into tanks for filtering. Specifics about each step of the process are provided below.

Distilling began with the raw turpentine being poured into a cauldron or boiler, a copper vessel mounted atop the furnace. (Emptied barrels were placed on racks to drain and collect the residue from



Charging the Turpentine Still  
(courtesy of Fort Bragg Department  
of Public Works).





Emptied Barrels Being Drained of Crude Turpentine Residue. Note the draining channel on the ramp with spout and collection barrel. Unknown Location and Date (Florida State Library).

The Traditional Method of Gauging Distillation Progress: Listening to the Sound of the Heated Gum. The spirits are being double-separated. Unknown Location and Date (U.S. Forest Service).





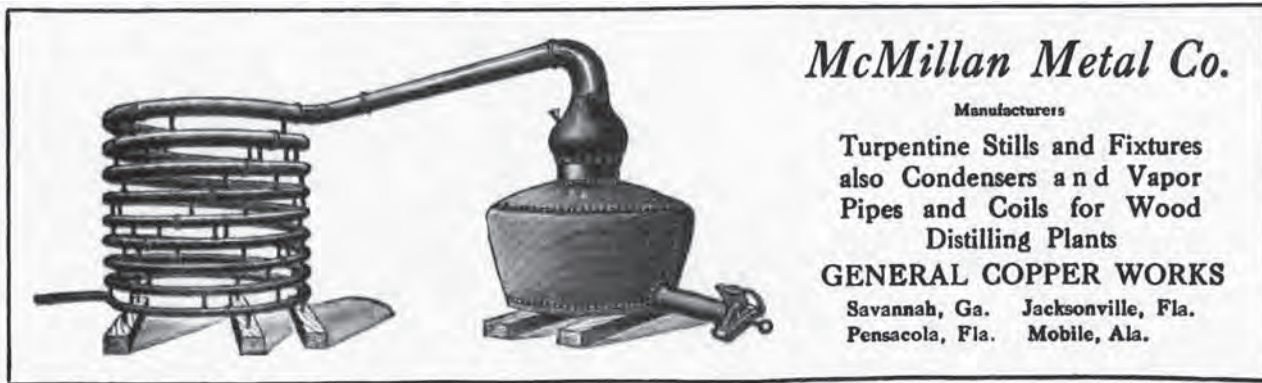

Turpentine Still and Fixtures. When in use, the coil would be inside a large tank filled with cold water (Gamble 1921).

the charging). The furnace, consisting of a masonry structure below the still, heated the raw turpentine to a temperature necessary to produce steam but not boil. The steam, composed of turpentine and water, passed through the water-cooled condensing tube or worm, producing a liquid composed of two parts spirit and three parts water. The liquid collected in a barrel or tank and the lighter spirit was skimmed off into barrels for storage and shipping.

Collecting the Turpentine Spirits. The mixture of turpentine spirits and water emptied into a tub. The spirits were skimmed off and barreled (courtesy of Fort Bragg Department of Public Works).

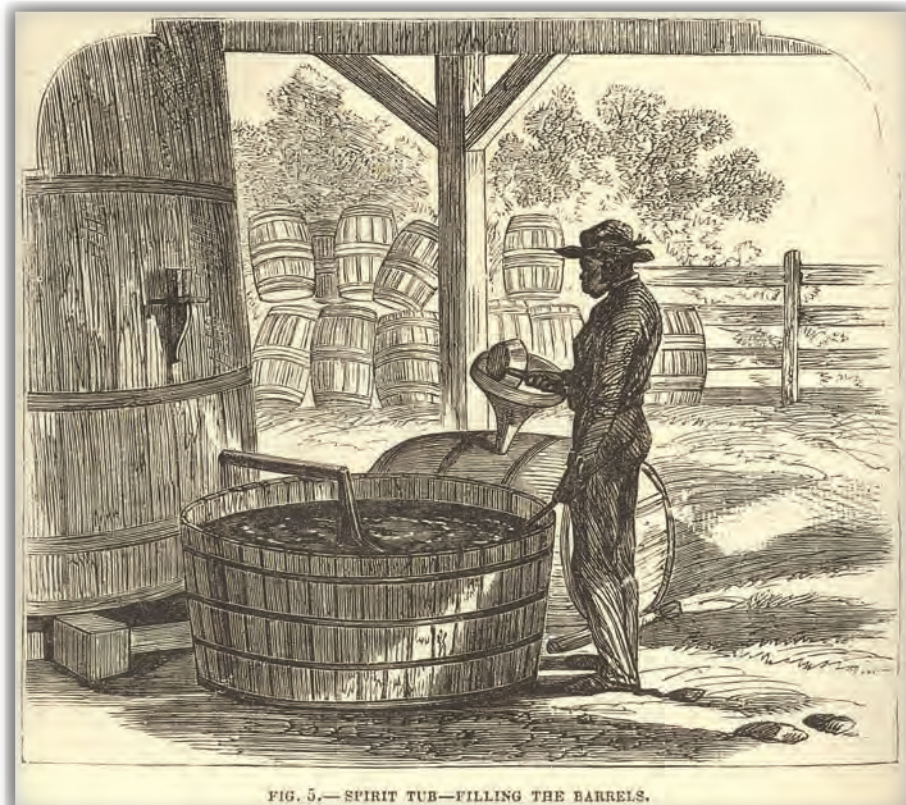





#### ROSIN COLLECTION

A. The rosin was drained from the still out of a conduit behind the firebox. The stacked wooden boxes are strainers. Wauchula Area, Florida, 1920 (Florida State Library).

B. Dipping the Rosin into a Storage Barrel. Florida 1928 (U.S. Forest Service).



Following the distillation, the boiler was cooled to prevent scorching the left over rosin. This material was then drained from the still through an outlet valve known as a “tailgate” on the rear of the hearth structure. The rosin poured from the tailgate through several screens of decreasing mesh size to remove impurities and debris, finally settling into a tank or trough on the ground floor of the distillery. From here, a worker dipped the rosin into barrels for storage and shipping (Greeley et al. 1873:981; Abbott et al. 1995:54; Outland 2004:75-77).

The turpentine industry involved various specialized skills. Cutting boxes and hacking, as noted, comprised skilled activities. Additionally, during the distillation process the fire and still

required careful monitoring and maintenance without the aid of gauges or other measuring equipment. Coopers were also skilled workers employed by turpentine producers. Barrels were a critical component of turpentine making, and, on average, one man per five workers engaged in making them (Abbott et al. 1995; Outland 2004). With respect to the organization of the industry, the harvesting and distilling might be owned by a single concern but more often they were handled as separate businesses, at least during the last part of the 1800s (Greeley et al. 1873:981).



Cooper's Shed and Work Area at a Turpentine Distillery. Note the quantity of barrel staves piled behind the shed (Gamble 1928).

Like the tar industry, turpentine harvesting was conducted in far-flung and isolated areas. The ideal orchard consisted of one to two thousand acres of pines located near water transportation. The distilling, however, was typically performed in centralized locations and often alongside major rivers or in coastal areas that offered water transportation. The harvesting period lasted from spring to fall and operated almost continuously as the cuts made in the trees had to be freshened every few days and the dipping done as often. There was thus no hiatus in the work, once it began, during which time the workers could



Housing for "Colored Help  
Required at a Turpentine Camp."  
Unknown Location, Twentieth  
Century (U.S. Forest Service).

return to their homes and eventually housing was provided near the work areas. During the antebellum era, slaves performed the harvesting and the work was most often organized by task because it required spreading out in various directions and prohibited close supervision (Outland 2004:78).

Archaeological remains and material culture associated with the turpentine industry would include those related to harvesting and distilling. Harvesting areas consisted of large forested tracts of several thousand acres. Workers operated in these areas for several months but did not live in them permanently. However, because the harvesting areas were used repeatedly for several years, central camps might exist with semi-permanent residential facilities, stables, sheds, dumps, and artifact scatters reflecting generalized domestic activities. Adams (2002) documented a possible antebellum workers camp at Neale Plantation in the Lower Cape Fear Valley. Material remains here included evidence for a simple, earthfast structure measuring 15x13.5 feet with a possible shed roof. Associated features included a possible shed, an exterior hearth, and storage pits. Adams (2002:69) cited contemporary sources suggesting that workers' accommodations consisted of little more than lean-tos barely large enough for a few men to crowd into.

Specialized artifacts would also be expected, particularly tools associated with cutting the trees and collecting the sap, such as specialized knives and axes. Later sites might also include Herty cup fragments, folded metal cups, and metal aprons. Studies of turpentine making sites at Fort Polk, Louisiana indicate



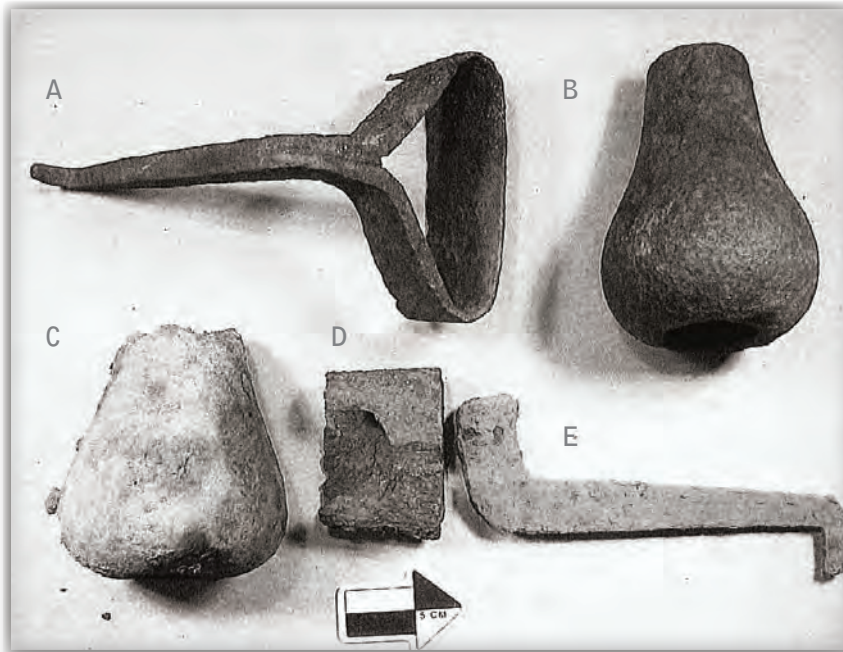

Turpentine Workers' Tools Recovered at Site 31HK1624, Fort Bragg, Hoke County, North Carolina (Steen 2006). a. Scraper; b and c. Hack weights; d. hack blade; e. scraper tang

Remnant of a Box Cut Tree (Site 38RD808), Fort Jackson, South Carolina (Dawson et al. 2007).



that workstations associated with this industry should be distinguished by a high proportion of glass artifacts relative to ceramics, limited or no architectural artifacts, Herty cups would comprise at least one-third of the assemblage, and privies would be present. These sites probably reflect turpentine workers' camps, and an analysis of their distributions indicated they were located mainly in floodplains (Anderson et al. 1988:253, 269).

Other features associated with naval stores are the trees themselves, which, as discussed, were modified in specific ways. Trees and stumps with boxes and chipped faces have been documented at Fort Bragg and Fort Jackson. They typically occur as isolated examples although their presence testifies to former turpentine orchard locations.

Distilleries had more substantial sets of components and potential archaeological remains. The buildings and sheds were typically open-sided, post-in-ground structures. The heat source, a masonry furnace, was on the ground level and contained a full chimney. The distilling process also required the massive condensing tank, which might rest on wood beams or masonry foundations, along with a well and associated tower, used to hoist water up to where it could be poured into the condenser. The rosin-collecting tank or troughs were often sunk into the ground and might be lined. They should leave a distinct archaeological signature next to the furnace. All of the functions of the distillery also had associated activity areas that might leave archaeological features. These include packed or worn earth floors and postholes and molds from the various sheds, ramps, stairways, loading platforms, and other auxiliary structures.





At least one ancillary structure at a turpentine distillery was the cooper's shed. Other buildings observed in historic images include small sheds or cabins that might have served as workers' housing. Larger frame houses were also depicted in some instances. Roads, railroads, and other features related to transportation were also present at some distilleries. Important elements of the distilleries that might not have obvious archaeological signatures were storage yards, particularly those used for storing barrels.

A Turpentine Distillery. This view shows the extensive area used for barrel storage (courtesy of Fort Bragg Department of Public Works).

### ARCHAEOLOGY OF NAVAL STORES PRODUCTION AT DOD INSTALLATIONS

At the DOD installations in this study, archaeological resources associated with naval stores production include tar kilns and materials related to the collection of pine gum. No turpentine distilleries have been identified. Of

the six installations, Fort Bragg has conducted the most research into these kinds of resources. Isolated features and artifacts associated with naval stores have been identified at other installations, however, and, given how widespread this industry was, more sites undoubtedly exist at all of the installations. The site types associated with this industry, particularly tar kilns and turpentine trees, are potentially common but are often overlooked during archaeological surveys because they are not readily identifiable as historic sites. The prevalence of tar kilns at Fort Bragg, in fact, is in part due to surveys being conducted by a particular field director who was familiar with the characteristic features (Linda Carnes-Naughton, personal communication, 2009).

To date, 26 tar kiln sites have been identified at Fort Bragg. Thirteen of these were identified during a single survey by Gray and McNutt (2004) working for Panamerican Consultants, Inc. (PCI). As a result of the survey, three types of tar kilns were identified: circular, oval, and rectangular. Citing Harmon and Snedeker (1993), Gray and McNutt (2004:558) noted that although the rectangular forms were considered to represent twentieth-century types, all of the tar kilns they identified possessed trenches around the circumference, which they stated was a twentieth-century trait. In the sample of 13 tar kilns, eight were circular, three were rectangular, and only one was oval-shaped. Information provided by Fort Bragg indicates that of the 26 kilns, 14 were circular and seven were rectangular. Three were oval and the remaining two were not specified.

All but two of the sites lay in upland positions, either on ridgetops or slopes below the ridge. One kiln occupied a bench, while Site 31HT911 was on a stream bank. This site exhibited several unusual attributes besides its location. For one, the site included an earthen dam, suggesting activities in addition to tar making. Additionally, a circular depression, measuring 2.0 meters in diameter, was found near the terminus of the earthen dam. Gray and McNutt (2004:213) interpreted this feature as a possible pitch-boiling pit. Finally, the site contained remains of at least two kilns whereas all but one other site contained only one kiln.

The only other site with more than one kiln was 31CD1613, which contained two kilns. These included one circular and one rectangular example, which probably indicated the use of the same location at different time periods.

In general, shovel testing in and near the tar kilns yielded charcoal but no other historic cultural materials. This was also true at Site 31HT911, despite its larger size and more extensive array of features (Gray and McNutt 2004).

While Fort Bragg contains recorded sites directly related to pine tar production, no turpentine-making sites have been documented. However, archaeologists have found assorted resources associated with the process. In particular, old pine trees exhibiting the characteristic hacking scars have been mapped throughout Fort Bragg (Culpepper 2006). Additionally, archaeological investigations at residential sites have yielded tools and equipment associated with turpentine making. In particular, Steen's (2006) testing of five sites produced a collection of hardware that included at least one turpentine axe, used to cut gum boxes into the trees, counterweights and blades for hacks, and the blade to a scraper for removing the hardened gum at the end of the collecting season. These items came from domestic sites and presumably belonged to the occupants. They attest to the production of turpentine in the Fort Bragg vicinity and indicate that former residents of the area were involved in it.

To the south, archaeologists at Fort Jackson have also recorded evidence of turpentine production. At this installation, one site (38RD632) was identified as a "turpentine collection and/or storage site" consisting of a small concentration of artifacts. These included two pieces of tin, interpreted as fragments of turpentine collection trays and a complete "embossed turpentine collection bottle made of brown glass" (Roberts et al. 1992:250). The artifact inventory describes the embossing on the bottle as "400,4," making it unclear how the investigators interpreted its function. Moreover, the pieces of tin were not clearly described and it is unknown how they were identified as related to turpentine collection. No other artifacts were found at this site to suggest a function.

Aside from this site, archaeological surveys at Fort Jackson have identified several trees showing scars and equipment from pine gum harvesting. One of these was associated with a prehistoric site, 38RD808, and consisted of a pine stump with a cut box and hack marks. Phase II investigations that were focused on the prehistoric component did not recover any historic artifacts associated with gum harvesting (McLeod et al. 2000:57). In addition, four trees with tin collection cups still attached have been recorded as archaeological occurrences at Fort Jackson (Steen and Braley 1992:183).

At Robins Air Force Base, Site 9HT7 produced numerous Herty cup fragments. These included buff- and red-bodied specimens (buff-bodied being most common). An example shown in an artifact photograph had a wide collared rim and narrow vertical ribs around the entire body. No other historic artifacts were found at this site (Blanton and Reed 1987:65-66). Additional Herty cup fragments were found at 9HT26, another mainly prehistoric site located on Sandy Run Creek (Hammack, personal communication, 2009).

Four sites (9CE557, 9CE661, 9CE716, and 9CE1798) at Fort Benning have also produced evidence of turpentine-making, consisting mainly of Herty cup fragments. Site file data indicated that one site also contained trees with possible hack scars. In addition Site 9ME770 at Fort Benning contained a tar kiln. The feature was described as measuring approximately 13 feet in diameter and having a thick charcoal layer at its base.

Little evidence for tar or turpentine making has been identified at Fort Gordon. One site, 9RI931, was described as a charcoal kiln. Site file data, however, indicated the feature consisted of a low, circular rise measuring around 20 feet in diameter and had a shallow depression at one side. The size and characteristics of this feature are consistent with a tar kiln.

Although few sites related to tar and turpentine production have been recorded at the six installations, this is probably due to the difficulty in recognizing the archaeological features these industries create and their low visibility. At Fort Bragg, once surveyors recognized the characteristic features of pine tar production, numerous kiln sites were identified based on surface features. Shovel testing at standard survey intervals and directly in association with these features, however, produced few or no artifacts, indicating they would be extremely difficult to find unless surveyors specifically looked for them. Similarly, the most obvious residues of turpentine harvesting might be remnant trees, scraps of metal cups and gutters, fragments of ceramic Herty cups, and assorted tool fragments. Many of these might not be identifiable as specifically related to turpentine procurement and, because they were in use at widespread and briefly visited locations, might occur as isolated finds. Consequently, the odd find relating to turpentine collecting might not be recorded as a site representing an industrial activity. Historical evidence, however, indicates that tar and turpentine were extensively produced throughout the southeast and archaeological evidence of these industries should be common at the Sand Hills DOD installations.

## SITE LOCATIONS AND DISTRIBUTIONS (GIS DATA)

Data on tar kiln locations at Fort Bragg is useful for exploring spatial patterns among these features. Twenty-six tar kilns have been identified at Fort Bragg. Looking at how the tar kilns were distributed can reveal behavioral patterns and might indicate how tar makers used pine forests.

As noted, the tar kilns at Fort Bragg are mostly located on certain landforms, particularly ridge crests and slopes. The ideal arrangement was to place the kilns on a slight slope with the collection pit on the low



side of the kiln to assist the flow of tar. Kiln distributions also suggest an affinity toward roads, including improved roads and unimproved trails. It is unclear if these routes comprise historic features that would have existed when the kilns were made. In some instances, the association between tar kilns and existing roads could also reflect greater visibility of features in these locations.

Looking at kiln distributions and spacing suggested inferences about forest use and specifically how forest tracts were divided up for tar production. Data for this analysis came from 14 sites located within the four separate areas that Gray and McNutt (2004) surveyed. The rationale for using only these sites was that the four survey areas were covered systematically and therefore most of the kiln sites in them should have been identified. Although additional sites are recorded outside of these survey areas, the associated tracts have not yet been examined systematically and so the absence of kilns could be a result of sampling error rather than past behavior.

Analysis of the kilns' spacing indicated that they averaged 1,235 feet apart, with a range between 48 and 5,857 feet. The one example (31CD1119) that lay at the extreme long end of the range is anomalous in this sample. The kiln with the next longest distance to its nearest neighbor is 2,557 feet away. Removing just the one outlier from the group brings the average distance apart to slightly less than 820 feet. Of the 14 kilns, 85.7 percent (n=12) are within about 1,530 feet of the next closest kiln. Just over 40 percent (42.9%) are within about 515 feet of their nearest neighbor.

## DISTANCES BETWEEN TAR KILN SITES AT FORT BRAGG

SITE	DISTANCE APART (ft/m)	CLOSEST SITE
31CD1170	48.03/14.64	31CD1168
31CD1168	48.03/14.64	31CD1170
31HT916	249.1/75.94	31HT946
31HT946	249.1/75.94	31HT916
31HT905	517.4/157.71	31HT929
31HT929	517.4/157.71	31HT905
31HT911	902.1/274.97	31HT930
31HT930	902.1/274.97	31HT911
31HT927	1063.2/324.06	31HT929

SITE	DISTANCE APART (ft/m)	CLOSEST SITE
31HT928	1,313.1/400.23	31HT927
31HT926	1,532.4/467.08	31HT931
31HT931	1,532.4/467.08	31HT926
31HT921	2,556.9/779.35	31HT916
31CD1119	5,857.2/1785.27	31CD1170
<b>Average Distance Apart</b>	<b>1,234.9/376.40</b>	

Using the average distance apart (and excluding the outlier) suggests that tar kilns lay in the center of areas measuring approximately 12 acres. This area might comprise the size of the forest tract that was cut to build a single kiln. There are some caveats to this analysis, however, the first being that the calculations based on distances between kilns do not take into account chronological differences. Therefore, the distances between successive kilns might be greater than suggested by these data. Second, the sample size is very small and it cannot be used to confidently draw conclusions about the use of space. Finally, as discussed below, kiln density at Fort Bragg is much lower than has been found in the Coastal Plain of North and South Carolina, which suggests that the number of kilns in this sample substantially under-represents the actual number of kilns that once existed here. Additional research is necessary to determine how closely this sample represents the total population of kilns in the region.

Although this analysis did not provide strong conclusions, the point of performing it was to highlight the potential of spatial data to provide insight into past land use and other activities. To conduct these kinds of studies, however, larger data samples are necessary as well as better chronological information.

## RESEARCH RESULTS AND QUESTIONS

Documentation and research of tar and turpentine making in Sand Hills DOD installations have been very limited to date. Although a number of tar kilns sites have been identified at Fort Bragg, none have been recorded at any of the other installations. Moreover, the 26 kilns at Fort Bragg represent a very small sample. Although tar kilns are relatively uncomplicated features that typically produce few artifacts, they have considerable potential to provide important information on this historically significant industry.

Harmon and Snedeker (1993), who have conducted the most extensive research into these sites to date, provide guidance concerning important research issues and questions. One issue they addressed was site density. They cited their own survey in Croatan National Forest, North Carolina, where kiln density averaged roughly one kiln per every 43 acres surveyed, and compared it to a survey of Francis Marion National Forest, South Carolina, where one kiln was found for every 115 acres. The explanations for this disparity could relate to North Carolina's longer and more intensive involvement in naval stores, or to more extensive agriculture in South Carolina, which has the potential to destroy kiln sites (Harmon and Snedeker 1993:118).

The Fort Bragg survey that documented 13 kiln sites covered 3,600 acres, thus averaging one kiln for approximately every 277 acres (Gray and McNutt 2004). The small number of kilns identified at Fort Bragg, however, does not provide a strong basis for drawing conclusions. Moreover, there is no comparable data from the other Sand Hills installations. A research objective for this industry, therefore, would involve documenting the sites and then making interregional comparisons between installations as well as between the Sand Hills and Coastal Plain.

Distributions of tar kiln sites are a second topic. As seen at Fort Bragg, kilns were mostly located on ridge tops and slopes. Harmon and Snedeker (1993) recorded them on similar landforms, although in their Coastal Plain survey area, the ridges and knolls were lower than in the Sand Hills and typically could not be seen on topographic maps. Harmon and Snedeker noted that the kilns in their survey were also usually placed at seasonal drainages. A difference between the Fort Bragg data and Harmon and Snedeker's (1993) results was that in their Coastal Plain sample, kilns tended to cluster, leading them to conclude that if a kiln were found, others would be nearby (they do not state what degree of proximity constituted a cluster, but indicate that in some cases kilns were located on the same landform and within 300 feet of one another [1993:108].) In contrast, the survey of Francis Marion Forest in South Carolina produced results similar to Fort Bragg, where kilns tended to occur in isolation. Again, additional documentation of kiln sites is required to address distribution patterns.

Questions also remain concerning the chronology of tar kiln sites. Harmon and Snedeker (1997:119) cited historical sources that suggest changes in the formal and functional attributes of kilns over time. These have yet to be tested archaeologically. To deal with this issue, means will have to be found to determine chronology. Harmon and Snedeker proposed dendrochronology as a possible dating tool. They also thought that relative dates could be determined by location: kilns closer to navigable rivers would probably be earlier while those near historic roads would be later. Also, continued testing and

excavation of kilns would eventually yield diagnostic artifacts. These efforts should help to illustrate possible variations in kiln morphology over time, which would then further assist in dating them (Harmon and Snedeker 1993:119-121).

Harmon and Snedeker (1993:121) also propose that comparing kilns at multi-kiln sites as well as between them and single-kiln sites would indicate whether the different types of site reflect dissimilar scales of production or varying organization of the industry. They further suggest identifying wood species used to fuel the kilns. This information would shed light on the relationship between the kiln sites and their local environments. Finally, it would be important to find the sites associated with the kiln workers. These would probably be low-density scatters but might contain evidence of shelters and generalized domestic activities. Harmon and Snedeker (1993:121) pointed out that these sites reflect the only first-hand records of the laborers who made and operated the tar kilns.

For turpentine making, there has been very little documentation of archaeological sites and as a consequence, research issues tend to be oriented around defining the archaeological universe. Thus the first issues are to locate distilleries and begin working out variations in their locations and densities over time. Chronological issues are particularly interesting because this industry persisted for several hundred years in the southeast.

Other areas of interest relate to the scale of the turpentine industry. As turpentine became important for various industrial purposes during the nineteenth century, it would be worth determining how changes in the scale of production and technology were manifested at distillery sites. The organization of the industry also changed as it went from a plantation-based activity to one with more input from corporate interests later in the nineteenth and twentieth century. Again, it would be worth determining how archaeological sites reflected these kinds of changes.

Finally, the industry workforce is an appropriate subject for archaeological study. By the twentieth century, if not earlier, workers were housed in camps near the distilleries and turpentine orchards (Bryant 1922b; Gamble 1922:104). These camps have the best potential to provide information about the lifeways of turpentine workers. The kinds of questions to address at these sites include the entire range of issues dealing with residential activities and industrial laborers. A partial list of topics to study includes how the workers were housed and supplied, diet, sanitation, demographics, ethnicity, gender and domesticity, and occupational identity.



## GETTING GOOD WOOD FROM BAD PLACES: LOGGING AND LUMBERING

The timber industry comprised one of the leading economic activities in the southeast in terms of value. Lumber as a commercial product had existed in the southeast since the colonial era but grew enormously after the Civil War as northeastern forests became exhausted and lumber companies began searching for fresh timber sources. Up to that time, small markets for southern pine, limited transportation routes through the pine belt, and shortages of capital for obtaining large forest tracts and establishing high-volume lumber mills hampered development of a southern-based timber industry and left southern forests relatively unexploited for lumber production except for local use. The industry was primarily developed by northern-owned national lumber interests, which had been spreading throughout the country (Outland 2004:135).

Financed by Northern capital and encouraged by the railroads, the South's lumber industry grew steadily during the 1870s and 1880s before ballooning in the 1890s. The growth of the industry created changes in land use and the organization of harvesting and processing. As the industry developed, the size of property holdings increased. Mill size also grew, and while earlier small, southern-owned mills were dismantled and moved to the timber as necessary, newer mills were established in one place and the timber brought to them. Although sometimes characterized as a complement to naval stores, the lumber industry competed with naval stores producers for the same raw material. At the time, trees that had been harvested for turpentine were considered inferior for lumber (Outland 2004:137). Also, logging interests viewed naval stores production as potentially detrimental because it damaged the lower portions of individual trees, making them useless for lumber, while also putting entire timber stands at risk from fire and wind damage (Bryant 1913:442). Because lumber producers could draw on larger capital reserves, they could out-compete naval stores businessmen and so pushed that industry further south and west (Outland 2004:137).

A forest being logged was an active scene, with several functions spread out over a considerable area. The process of logging included three principal steps: cutting down trees, turning them into logs, and transporting the logs to the mill. These steps required certain skills and knowledge on the part of the loggers to ensure safety and efficiency. Bryant (1913) provided a detailed description of the process, which is summarized below. The following discussion deals only with logging, the process of harvesting trees and bringing them to the mill. The process of turning them into milled lumber is described in Chapter 2.

The first step in the process was felling, which involved not just toppling trees, but consideration of the direction of fall. After taking into account the natural lean of the tree and weight of the crown, the loggers needed to ensure the tree would not become caught in adjacent trees or be damaged during the fall by hitting stumps or other obstacles. Trees could also be felled in a direction that facilitated their removal from the forest ("skidding"). In southern pine forests, sawyers often worked in crews of two



under the supervision of a logging boss who assigned work zones, marked trees for felling, and indicated the length of logs to be cut. The sawyers were responsible for both felling and cutting the trunk into logs. To fell a tree, the sawyers first cut a notch into the trunk on the side it was intended to fall and then cut through from the opposite side and slightly above the notch. Both axes and saws were used for felling along with wedges driven into the cut behind the saw to prevent binding.

#### FELLING A TREE.

A. The first step in felling was to chop a notch in the side of intended fall. North Carolina, 1940 (U.S. Forest Service).

B. Felling a Pine Tree with a Two-handed Crosscut Saw. Arkansas, 1942 (U.S. Forest Service).



The next step was log making, during which the felled tree was sawn into sections for transportation to the sawmill. The bole (the trunk portion between the roots and point where the branches began splitting off) comprised the most valuable part of the tree. The bole had to be separated from the crown and isolated branches were removed from the trunk. A member of the saw crew could perform this task with an axe or it might be the responsibility of a specialist known as a "swamper," "knotter," or "limber."

The trunk was then sawn into logs of specific lengths, an activity called “bucking.” The length of the logs and whether the entire trunk was utilized was determined by intended use. In the pine board-producing region of the Southeast, 12-, 14-, and 16-foot lengths were typical, although longer lengths might be used if power skidding was available. In this case sometimes only the crown was removed and the rest of the bole was hauled to the mill to be cut up. Before segmenting the bole, a member of the sawing crew or a designated person known as the “chipper” marked out the desired lengths with a measuring stick, made from a wooden pole marked at regular intervals. These were often metal-tipped because sawyers tended to chop off the ends while using an axe to mark the bole. As with the felling, wedges were used to keep the saw from binding during log making and kerosene would be applied to the saw to keep the sap from slowing it.

Equipment used for felling and log-making consisted of crosscut saws, usually 6.5 feet long with detachable handles. Saw teeth were available in several patterns, with different ones being better for different wood types. In regions producing yellow pine, such as the Sand Hills, perforated lance teeth in sets of four were preferred. Axes could be either single-bit or double-bit and came with straight or curved handles in different lengths. Sawyers chose the types best suited to their work and preferences. Even



“Bucking”: Sawing Felled Trees Into Logs. Near Columbia, South Carolina, Unknown Date (U.S. Forest Service).



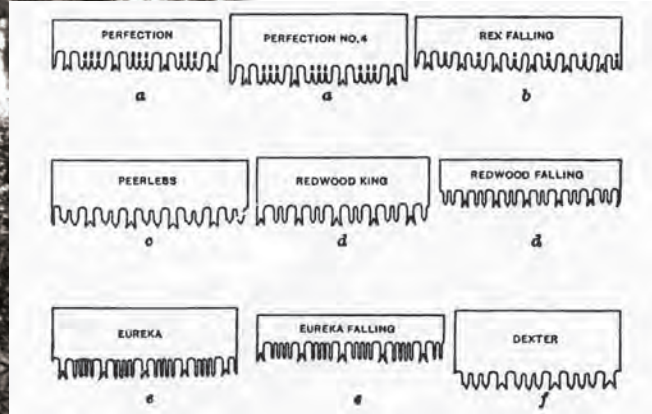
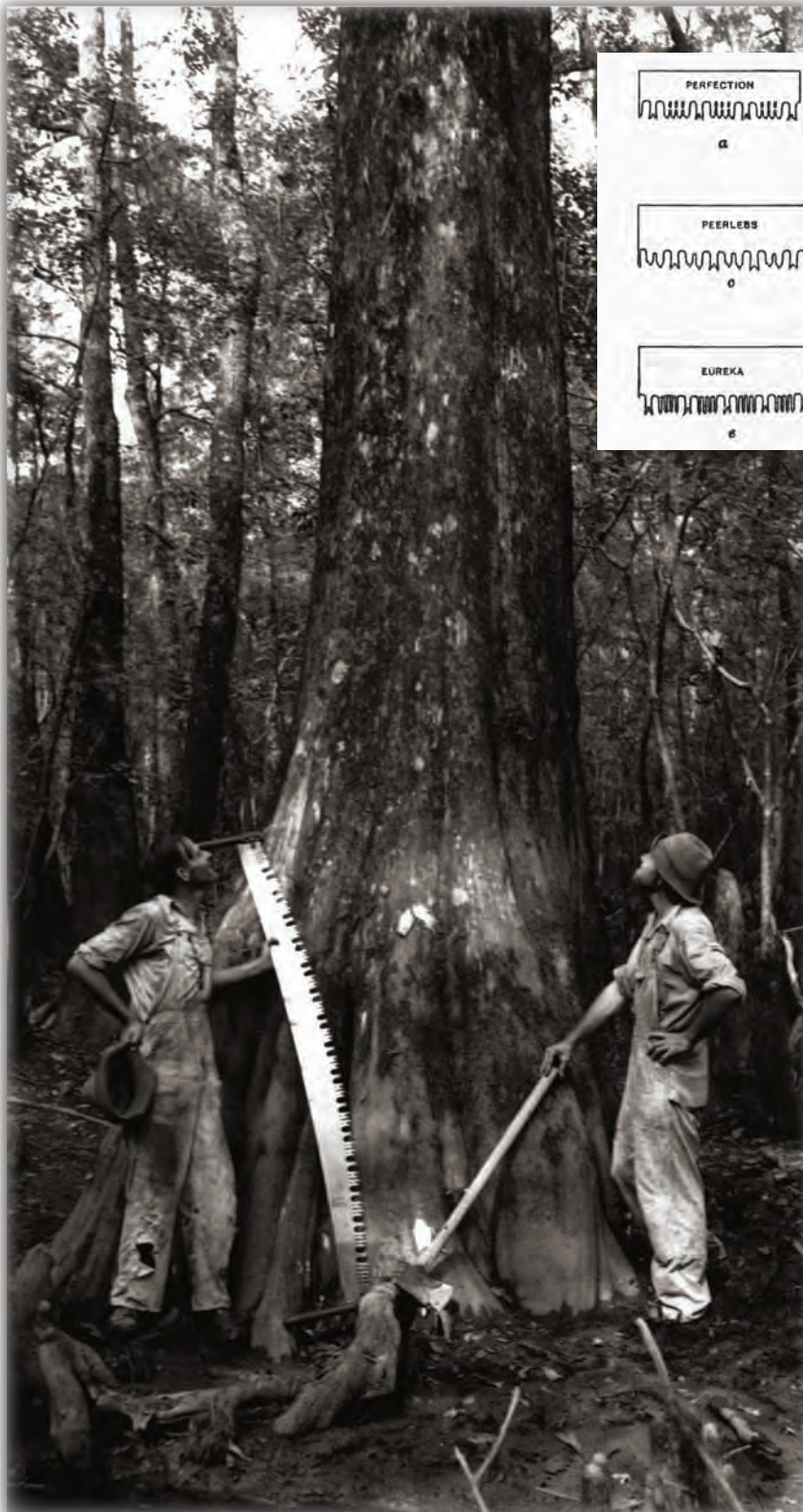

#### LOGGING SAWS

A. Tree felling crew with a crosscut saw and felling Axe, Florida, 1949 (U.S. Forest Service).

B. Examples of saw teeth patterns. "Perfection" was commonly used in the Sand Hills (Bryant 1917).



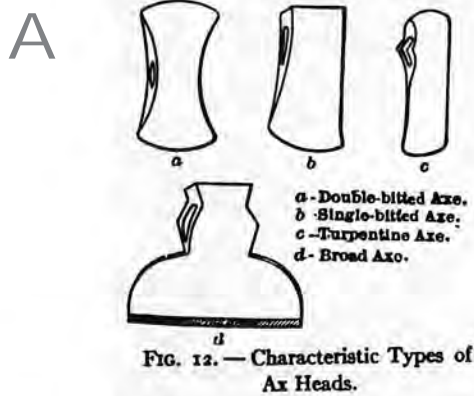

## AXES AND WEDGES

A. Axe Head Varieties. Double and single-bitted were used for Felling (Bryant 1917).

B. Sample Wedge Patterns used by Loggers (Bryant 1917).

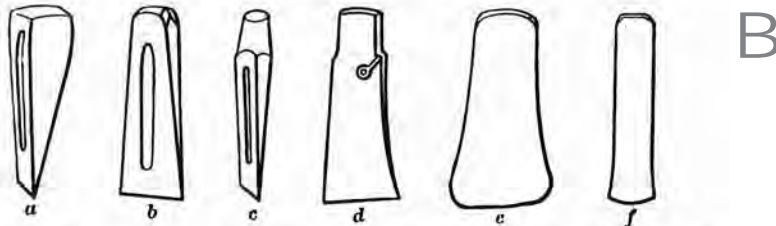

17. — Some Patterns of Wedges used by Loggers. a. A wood chopper's wedge. b. Tie maker's and faller's wedge. c. Wood chopper's wedge. d. Faller's wedge. e. Faller's wedge, Pacific Coast type. f. Log-maker's wedge, Pacific Coast type.

wedges came in various patterns and sizes and could be either metal or hardwood. By the early twentieth century gasoline-powered chain saws had been developed. These were large machines weighing around 1,200 pounds that were mounted on 13-foot long skids and dragged through the forest. They do not appear to have been used in the Sand Hills to any significant degree.

Felling and log making utilized a variety of other tools and equipment, including wooden mauls and iron sledgehammers for driving wedges. Another tool was the "kilhig" or "sampsom," consisting of an eight to 16-foot wooden pole used to lever falling trees in particular directions. These were expedient tools as sawyers tended to cut them as needed rather than carry them ready-made into the forest. The "peavy" was a lever used to handle logs and consisted of a metal spike with an attached hook mounted on the end of a pole. "Cant hooks" were similar implements to peavies but rather than a spiked end, cant hooks were topped with a heavy band of metal and a small projecting "toe." They were used for similar purposes as the peavy but more often in the sawmill or lumberyard than in the forest because they did not mar the wood. Finally, the "pickaroon" was a metal hook attached to a wooden handle used to grab and move pieces of timber or lumber.

Removing the logs from the forest involved two distinct procedures. The first was to collect logs at depots or central locations within the forest ("skidways"), a process known as "skidding" or "yarding." The second operation was to move the logs to the sawmill or an intermediate point for transportation such as a river landing or rail line. Transportation involved specific steps and equipment. Additionally, roads and railroads were built to bring out the logs, and numerous small trails were established through the forest for moving felled trees and logs to various points.



Ox Team Dragging Logs,  
Escambia County, Florida,  
1920s (Florida State Library).

There were numerous means for accomplishing these functions. For skidding, Bryant (1913:428) stated that draft animals were commonly used in the southeast to drag logs along the ground. Later, steam and gasoline-powered vehicles took over this function. Another skidding method used in level pineland was the "snaking system," which employed a steam-powered skidding machine from which cables were pulled to the logs and then reeled back to the machine, located in the skidway. Logs could also be moved around with wheeled vehicles, among which were a single-axle cart known as a "bummer;" a "high cart," having two large wheels between which the logs were slung; and wagons having four, six, or eight





Steam Powered Skidder.  
In this photograph, the  
equipment is being used to  
load logs onto a rail car.  
South Carolina, 1904 (U.S.  
Forest Service).

#### VEHICLES FOR SKIDDING LOGS

A. High Wheeled Cart with Log Slung Underneath.  
Note the established trackway for cart traffic.  
Suwannee County, Florida, 1903 (U.S. Forest Service).

B. Two-Axled Cart for Skidding. Calcasieu Parish,  
Louisiana, Unknown Date (U.S. Forest Service).



wheels. Skidding was facilitated with a network of trails and roads as well as various chutes and slides consisting of shallow trenches, sometimes augmented with logs or planks that acted as tracks or runners for sliding the logs. Establishing routes for skidding required clearing relatively straight pathways through the forest to allow draft animals, carts, and logs or trees to move easily. The cleared areas sometimes formed elaborate networks with smaller trails feeding into larger main lines that led to the skidway. These networks placed distinct imprints on the ground, whether it was cleared or not, because they often cut through the grade and had to be completely cleared of obstacles, including stumps, which were cut to the ground, to keep logs and equipment from snagging.

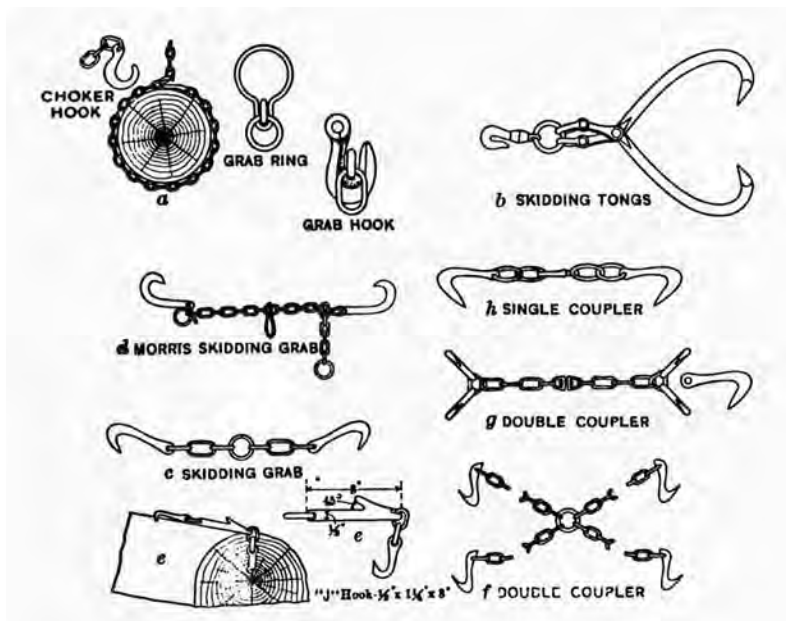

Hooks, Grabs, and Tongs Used for Skidding (Bryant 1917).

The variety of equipment used for skidding or snaking included the harnesses, doubletrees, and other tack used to hitch the draft animals to the logs or carts. Also, various kinds of chains, hooks, grabs, tongs, and couplers were used. "Grabs" consisted of paired hooks attached by short lengths of chain. The hooks were embedded in the log and the chain then attached to the harness equipment. The hooks were embedded with a metal-wrapped maul (the "grab maul") and removed with a pointed sledgehammer, the "grab skipper."

Establishing and operating the skidway involved more than simply dumping the logs until they could be moved forward. These were industrial workplaces that were organized logically and in ways to facilitate overall logging operations. Bryant (1913:140) noted that their character and location depended on the way the timber was hauled and the prevailing terrain. In the southeast, railroads were almost always used at industrial-scale logging operations. In such cases, skidways were linear clearings alongside the track where the logs could be stored prior to loading. The opposite side of the track from the skidway was also cleared to permit foot traffic. If they were to be loaded by animal power, then the logs would be stored parallel to the track in cribs made from rows of upright poles. If power loaders were available, a less orderly storage arrangement was permissible.





Skidway Associated with a Logging Railroad. Logs are arranged in rows parallel to the track for loading. Arkansas, Unknown Date (U.S. Forest Service).

Transportation to the sawmill was the final stage in logging, and railroads were commonly used for this purpose in the southeast until the advent of trucks and tractors. Floating logs on rivers was also done early on (South Carolina Forestry Commission 2009), but as logging areas moved away from the larger watercourses, temporary logging railroads became more prevalent and eventually replaced water transport altogether (Compton 1916:36).

Both narrow and broad-gauge tracks were used to get logs to the sawmill. The logging industry used fully functioning railroads with main lines and spurs that led into separate parts of the forest. Logging railroads possessed the same requirements as any commercial railroad, and had to be built to similar specifications. Right-of-way had to be cleared along the routes, requiring as much as 100 feet of ROW, while in the southeast 120 feet was common to allow skidway space alongside the tracks. Ground preparation necessitated cutting, filling, and removing obstacles to minimize grade changes and curves. Trestles and bridges had to be built for stream or valley crossings, and solid beds had to be established to support the track. These were substantial undertakings that called for the skills of surveyors, engineers, and track builders. These crews remained employed for the duration of the logging operation to perform maintenance and handle the frequent realignment of spurs to new forest sections.

Timber companies operated their own railroads at this time, owning the locomotives and rolling stock. Thus, engineers, firemen, and mechanics were also essential employees of the logging operation. Loading the cars initially could be done with draft animals pulling logs up the car deck on skids. By the 1880s, however, steam-powered mechanical cranes were developed that mounted on railroad cars or that ran on the tracks.

Logging also required camps occupied by the crews and sometimes their families. Bryant (1913:428) stated that portable houses were the most common types used in the southern logging industry. The camps also included a general store, church, and schoolhouse, all provided by the logging company. Where the loggers occupied the camps without their families, car camps were sometimes used. The chief characteristic of portable house camps was that the buildings could be moved as the logging progressed. The buildings were placed in the skidways along the main railroad line or a spur. Two or more buildings

Example of a  
Portable Lumber  
Camp. Montana,  
Unknown Date (U.S.  
Forest Service).



attached together could house a family, while single buildings could act as bunkhouses for two or more men. Large camps could contain over 200 houses and support 200 to 300 people, only 30 to 50 percent of whom were employed by the logging company. These camps comprised small villages and provided a range of functions, including, as noted, churches, schools, and stores, but also quarters for a superintendent, boarding houses for single men, barns for livestock, machine shops, storage buildings, coal bins for the locomotives, and a commissary. The commissary provided goods needed by the logging families, but in isolated locations local inhabitants also came to shop for merchandise, groceries, and feed.

Portable house camps were so called because they could be loaded onto log cars and taken to new locations. They were small (168-200 square feet) frame structures that were reinforced as necessary to facilitate loading. In warmer climates such as the Sand Hills, tents might also be used for some functions such as sheltering animals. Other options for stabling animals were car barns, consisting of flatbed rail cars with a superstructure added for storage. Stalls were partitioned off under shed roofs on either side of the car's exterior.

Car camps were also used in the south and consisted of boxcars modified to include sleeping areas, kitchens, dining rooms, offices, and commissaries. They were moved from site to site as the logging progressed and parked on sidings. Car camps could be moved rapidly and had the advantage of housing the logging crews near their work areas. Because of their expense, they were not considered practical for situations where entire families lived in the camp.

The existence of logging camps where families or only the logging crews lived required further specialized or dedicated workers who were not directly involved in the logging. In particular, the boarding department was in charge of feeding the crews. This division employed a head cook, who was responsible for the kitchen and dining room, as well as ordering and maintaining foodstuffs and related supplies. In larger camps, the cook had assistants ("cookees" and "flunkees") who performed many of the menial tasks such as prep work in the kitchen, waiting tables, dish washing, and other chores. Camps also employed "chore boys" who performed tasks like cleaning the crew's quarters, cutting firewood, building fires, and carrying water.

Bryant (1913:57) summarized the important physical qualities of camps. The site should be well drained and located away from swamps or mosquito-breeding areas. Perennial water supplies were important but not mandatory because water could be brought in on tank cars or wells could be dug. Natural sources

of running water for stock and laundry were desirable, however. The camp should also be convenient to the work areas. Finally, the area should be level and sufficiently large to accommodate the spur tracks and siding needed to move the houses and railroad cars.

Although extensive archaeological study of logging related sites has not been conducted in the Sand Hills, studies from other regions where logging was important provide guidance regarding the types of features and artifacts to expect at such sites. At Fort Polk, Louisiana, sites associated with the logging and lumber industries were divided into two categories: temporary workstations and trams. The criteria for identifying temporary workstations included high proportions of glass artifacts compared to ceramics, limited or absent architectural materials, no more than 33 percent of the assemblage would be Herty (turpentine) cups, and privies would be present. Trams consisted of raised or excavated linear earthen features. Distributions of these sites indicated that trams lay primarily on upland settings, probably to follow ridgelines and other access routes. Temporary workstations did not show definite patterns owing to a small data sample (Anderson et al. 1988:253, 269).

Another study of railroad lines used by logging companies indicated that they should follow an orderly pattern, often being laid out with main lines that led from the sawmill to the forest stands, with spurs extending from the main line. Whelan and Pearson (1988:43-44) reconstructed such an arrangement in use by the Good Land Cypress Company in Louisiana during the early part of the twentieth century. The spurs were parallel to one another and spaced at regular intervals (between 1,200 and 1,600 feet). Bryant (1913:147) illustrated a similar configuration at a West Virginia logging operation.

Logging-related features documented in the Hiawatha National Forest in Michigan's Upper Peninsula included logging dams, railroad grades, stump prairies, logging camps, and logging towns. Logging camps were described as the center of activity in the forest and were a comparatively common site type. Archaeological remains at these sites included earthen berms delineating former structures (the berms were piled up around the foundations for insulation), cellar or privy depressions, borrow pits, drainage ditches, and earthen ramps and mounds. Artifacts included tools, building materials, and domestic refuse (Franzen 1992:74).

Logging sites identified in the Cranberry River Valley in West Virginia were distributed along rail lines and were usually spaced one-quarter to three-quarter miles apart. The sites represented crew housing and consisted of small (less than 600 square feet), leveled shanty-car platforms parallel to the rail lines. They did not contain building foundations or other structural features visible on the surface. Associated artifacts



were dispersed across the site area or concentrated in dumps. Surveys in this region also documented a logging company town, Dogway. Documentary evidence indicated this site contained around 60 car houses and a combined company store and hotel. The archaeological remains covered an area over a mile from the rail line (Brashler 1991:61-62).

## ARCHAEOLOGICAL EVIDENCE OF LOGGING AT SAND HILLS DOD INSTALLATIONS

To date, no archaeological sites associated with historic logging activities have been recorded at any of the DOD installations included in this study. This is not entirely surprising, as the types of resources expected to be found, such as logging roads, skidways, and assorted activity areas would not typically leave distinct archaeological traces. In discussing the potential for identifying old roads and trails at Fort Benning, Gresham (1982:72) noted that in the sandy and hilly terrain, unimproved roads tended to shift laterally as roadbeds became impassible. The sandy terrain would also tend to erode evidence of roads and trails that were not deeply incised. As noted, logging roads in the southeast consisted of tracks from which stumps and other obstructions had been removed, but did not necessarily involve any other improvement for traffic except repeated use.

More substantial transportation methods might leave more visible evidence. For example, southern logging companies built railroads and tramways to haul logs and these can sometimes be identified archaeologically as embankments or other linear features used to support track. Along with road traces, these features can be expected to show definite patterns in the way they are arranged.

Logging camps are another site type that can be expected. These should produce more substantial archaeological remains than the work areas and should exhibit certain functions and features that were necessary in setting up and operating a logging camp, such as housing, sanitation facilities, and supply/commissary activities, among others.

## FUTURE RESEARCH

Archaeological research into the logging industry of the Sand Hills would initially focus on identifying the types of resources that exist and analyzing their locations in order to develop predictions about their locations. It should be remembered that a logging operation consisted of a large-scale and highly capitalized and organized activity covering extensive areas of forest. Individual sites, while not necessarily

significant themselves, can contribute to better understanding the way a landscape was utilized to generate forest products.

The principal types of sites can be categorized as work areas (felling, bucking, and skidways), transportation facilities, and residential camps. The first of these would not likely produce substantial archaeological evidence. At most, work areas would probably generate isolated finds or sparse artifact scatters. The locations of such sites should be mapped and their functions and chronology recorded, if possible, to obtain information on the distribution of work areas in a given region. Unless the site has substantial remains that could indicate the use of space, organization of activities, or other information, these sites do not likely have individual archaeological significance.

Transportation facilities, as noted, might be visible. The chief information potential of these kinds of sites would be their location, type, and construction. In attempting to study broader logging operations, these kinds of sites should be mapped as they are found and details of their construction recorded. Compiling this kind of data might ultimately indicate the scale and organization of logging activities in a given area, as well as the level of effort and investment put into them. Long-term preservation of these sites is not considered necessary.

Bryant's (1922b) field guide for studying logging and lumber operations contained topics applicable to an archaeological study of early twentieth-century logging camps. Issues dealing with these kinds of sites included the following: Factors governing site selection; kinds, size, number, and arrangement of buildings; construction; equipment and furnishings; camp hygiene; blacksmith and machine shop; tools supplied for logging; camp store; commissary department; and transportation of supplies (Bryant 1922b:7-9). This list would generate baseline data in studying a specific labor camp. The topics would have to be addressed with combined archaeological and historical investigations. Whelan and Pearson (1988) dealt with additional topics in their study of a twentieth-century lumber mill workers' village in Louisiana. These issues included diet, consumer patterns, social and recreational activities, ethnicity and socioeconomic status (this community was primarily working-class African-American), and economic relationships outside of the community. Whelan and Pearson (1988) noted that because this site represented a spatially and chronologically discrete occupation, it had a good potential to address a variety of questions without having to filter material from overlapping intensive occupations.

Of the resources associated with logging, camps have the greatest potential for addressing issues about the laborers in the logging industry, especially the domestic aspects of their lives. These sites should

contain privies, refuse deposits, and other features that traditionally provide significant archaeological data. Also, because logging camps were temporary nature and would not be reused over and over, they have a potential to possess tightly dated archaeological materials with good integrity. For management purposes, work areas and transportation-related sites and features, while capable of producing significant data, do not necessarily require permanent preservation, and can probably be dealt with through Phase I and II level investigations. Logging camps, however, if they possess integrity and good data content, should be preserved for study or subject to data recovery if they will be impacted as a result of DOD undertakings.



## CLAY INDUSTRIES: POTTERY AND BRICKMAKING

### POTTERY MAKING: THE FICTILE ART

Pottery making was a widespread industry in North Carolina, South Carolina, and Georgia and its products were integral to everyday life during the eighteenth to early twentieth centuries. Ceramic containers were used for food storage, preparation and serving; dairying; carrying water; sanitary purposes; and numerous other tasks. Many of these functions were met with stoneware and coarse earthenware ceramics turned out by local and regional potteries. Pottery manufacture could take place in almost any location with suitable clay supplies, but several centers of production emerged in the three states. These centers depended partly on the presence of clay sources but also possessed social and family networks that nurtured the knowledge of folk pottery production and brought together the supplies needed for its production (Joseph et al. 2004). In Georgia, centers in Washington and Crawford counties were in the Sand Hills, while the Edgefield District in South Carolina lay at the margin of the Sand Hills. North Carolina lacked a significant pottery center in the Sand Hills although two commercial potteries were established in Fayetteville. Pottery production centers were also located in the eastern and southern Piedmont of North Carolina, with Moore and Chatham counties being in the general region of the Sand Hills (Carnes-McNaughton 1997:13). These centers of production indicate a potential for commercial pottery production in the study area, although thus far no pottery making sites have been identified inside any of the DOD installations.

Pottery making in the Carolinas and Georgia was mostly associated with alkaline-glazed stoneware traditions, although other types of wares, such as salt-glazed and slip-glazed, were produced. Of the three states, North Carolina had the most diverse pottery traditions that originated with the Moravian potters of Salem. Lead-glazed earthenware production was begun in the eighteenth century by Moravian potters who immigrated to North Carolina from Germany and other regions of North America. Additionally, numerous non-Moravian earthenware potters operated in the North Carolina Piedmont (Carnes-McNaughton 1997:18). Earthenware never became a significant commodity in South Carolina and Georgia,



where stoneware dominated. The Moravians also produced salt-glazed stoneware pottery, although the first known commercial production of this ware came from the shop of an immigrant from Connecticut, Gurdon Robins, who moved to Fayetteville and transplanted the pottery making techniques and forms from his native state in the 1810s (Zug 1986). Robins recruited the assistance of Edward Webster, also a Connecticut potter, and his brothers Chester and Timothy. The Websters ultimately operated their own shop in Fayetteville after Robins' closed in 1823. The Webster pottery lasted until around 1837 (Hewitt 1995:30-31; Hewitt and Sweezy 2005). Salt-glazed wares were also produced in South Carolina and Georgia. Burrison (1983:58) mentioned it being important in some pottery-producing areas of Georgia from the 1870s to the mid twentieth century. Both lead glazed earthenware and salt-glazed stoneware were old traditions, having been developed in Europe and brought by waves of immigrants.

In the 1820s a new glaze emerged in South Carolina. Based on mixtures of wood ash and sand, alkaline glaze formed a thick lustrous coating on stoneware. While used in Asia, this glaze had not been adopted to the U.S. until its advent in the Edgefield District of South Carolina. Its emergence was based on the availability of the raw materials (wood ash and sand), its utility in simple groundhog kilns, and on its low cost compared to salt, a valuable commodity on its own (Baldwin 1993:16). Stoneware with alkaline glaze was developed in the Edgefield District of South Carolina and spread quickly into Georgia and North Carolina as well as further south and west as potters with the knowledge to make it migrated outwards (Burrison 1983:59).

Pottery makers in the Sand Hills mostly adhered to traditional methods for organizing their shops. Carnes-McNaughton (1997) described these potteries as cottage industries characterized by small-scale production, low overhead, narrow profit margins, seasonal activity, and direct contact between producers and consumers. The potters did much of the work themselves, having trained in the shop of a family member or neighbor. Greer (1981:39) indicated that the learning process followed a traditional sequence of apprenticing under a master, becoming a journeyman, and finally setting up one's own operation as a master. She remarks, however, that in the rural South, an entrepreneur might open a pottery and perform all of the unskilled work but then hire an accomplished potter to do the turning, which took considerable practice and skill (Greer 1981:41). Moreover, the apprenticeship process relied heavily on kinship, most often having sons, daughters, nephews, nieces, or in-laws learning from older relatives. Confining the learning process to family served to guard trade secrets, secured a reliable labor force, ensured access to necessary resources (e.g., clay deposits, timber supplies), and created networks of reciprocity backed up by blood or legal relationships (Carnes-McNaughton 1997:94-95).

In contrast to the traditional workshop, large pottery factories broke down the manufacturing process into specific tasks to be performed by separate people with little training and used mechanical equipment for many processes. Examples of larger pottery factories include the Stevens Pottery and the Milledgeville Brick and Pottery Works, both in central Georgia. These consisted of large industrial operations that produced not only ceramic containers, but other clay products as well, such as common brick, drain tile, and ornamental ceramics (Ladd 1898). Although the Carolinas and Georgia contained large factories, smaller workshops were more numerous overall. At the turn of the twentieth century, for example, North Carolina contained 40 to 50 potteries, and all were small, characterized as producing a combined capacity of around 25,000 gallons annually (Ries 1897:71). These smaller shops are the focus of this study.

Ceramic production involves obtaining clay, preparing it for molding, turning it into the desired forms, letting the green wares air dry, and firing. Glazing was commonly a step between air drying and firing but could be omitted in instances where the glaze was added during firing. Production required a mill for mixing the clay and glazes, buildings for housing the production process and drying, and a kiln (Joseph et al. 2004:123). Greer (1981) described the process of pottery making, with specific reference to stoneware.

The first step in the process was to obtain suitable clay. Ideal clay possessed plasticity, good wet and dry tensile strength, low iron content, minimal shrinkage, a suitable vitrification point, and adequate silica content. Sometimes mixing separate clays or adding certain components could achieve a suitable raw material. Access to the source was also important before mechanical excavation became available. Potters dug the clay by hand and usually loaded it into a cart for transportation to the shop. Four to five cartloads might be sufficient for an entire year's worth of production. Clay was often mined during the winter and allowed to weather outdoors until needed. Mining likely took place near the shop because it was unusual for traditional potteries to import raw clay from any great distance (Greer 1981:27). Potters mined the clay themselves if the clay pit was near the shop (Bowen and Carnes 2002:197). On the other hand, some potters purchased clay. Ries (1897:71) stated that in some locations, potters paid 50 cents per ton for clay (in the 1890s), and usually bought it on trips to deliver finished wares, taking the clay home in the wagon they made their deliveries with.

The clay was generally not ready for molding directly from the ground and it required washing and sifting to remove excessive grit and other particles. The process involved adding enough water to produce a slip that could pass through screens. From this point the clay was put aside in a vat to evaporate. Traditional potters used open-air pits and troughs lined with wood, brick, or earth to evaporate the clay. These were known as "sun-pans." Once dry enough, it was cut into blocks and stored until needed.



Pug Mill at a Small Country Pottery. Crawford County, Georgia, 1890s. (Ladd 1898).

If the clay did not require washing, it still usually needed processing to make it more malleable. The raw clay was pounded with a sledgehammer or ground in a mill and then mixed with water. While mixing could be accomplished by hand, mechanical pug mills were common. The pug mill consisted of a vertical cylindrical vat with a shaft down the center. As the shaft rotated, rods or blades attached to it mixed the clay. A lever at the top of the shaft was hitched to a horse or mule that circled the mill to activate the mixing process, although motorized types became available later. The clay was removed from the top or bottom of the mill. Motorized versions extruded the clay in a column that could be cut into manageable pieces for storage.

Turning or throwing (forming pottery vessels) was done on a potter's wheel. Early versions operated manually, the potter using his or her foot to move the wheel. Electric motors were added later. As the wheel rotated, the potter molded the clay ball into the desired form. The process used a variety of tools for shaping and removing the pots. For large vessels, which could use as much as 20 pounds of clay, the potter would use a tool called a "ball opener,"

Manually Operated Kick Wheels for Forming Pottery Vessels (Barber 1901).

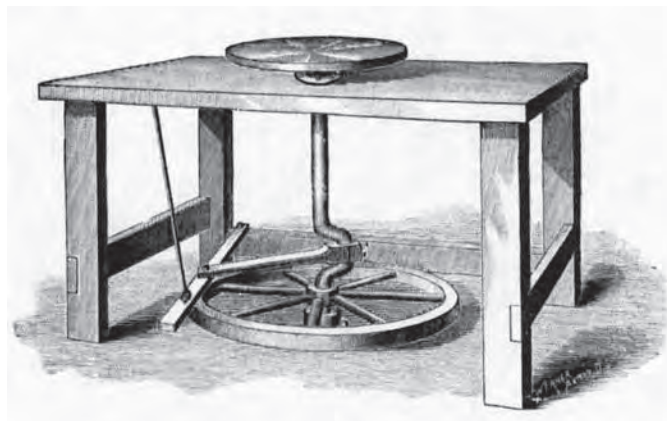



Hand-Throwing a Pottery Vessel (Zug 1986).

consisting of a lever attached to the side of the wheel frame. A piece of wood attached perpendicularly to the lever was placed into the starting piece of clay (the "ball") to open up the center and begin to form the sides. Other tools included wooden ribs used to shape and smooth the body and rim. A wire or cord was pulled under the finished vessel to cut it free of the wheel and it was removed with a set of lifters. The pots were then set aside to dry long enough to remove remaining water and become stiff enough so that handling would not distort them. To speed drying potters might set the green wares on shelves over a hot-air flue (Ries 1897:73).

After drying, the pots could be glazed if desired, using a variety of substances and techniques. In southern folk potteries and smaller commercial operations during the eighteenth to twentieth centuries, the most likely finishes included salt glaze, alkaline glaze,

Tools for Hand-Shaping Pottery (Rhead 1910).

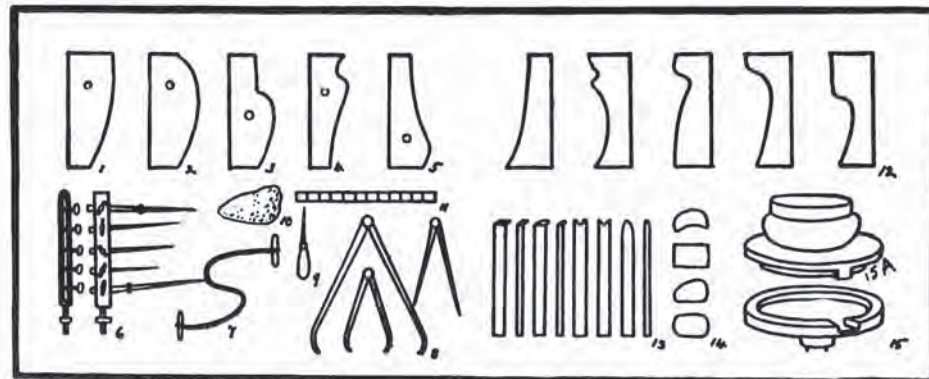
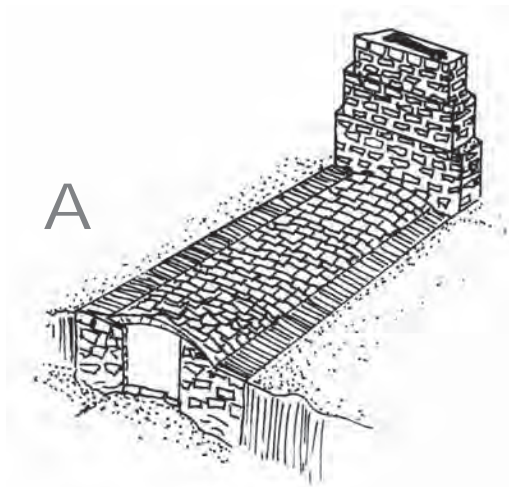

FIG. 52.  
1-5. Slate profiles. 6. Gauge. 7. Wire. 8. Calipers and compasses. 9. Spike or pricker. 10. Flat sponge. 11. Rule. 12. Sheet metal profiles. 13. Turning tools. 14. Rubbers and palettes. 15. Notch setter and top of wheel.





## GROUNDHOG KILN

A. Typical Location and Construction (Greer 1981).

B. Groundhog Kiln with Shed Roof and Associated Work Areas. Crawford County, Georgia, 1890s (Ladd 1898).



slips, and Bristol glazes or slips. Painted, stamped, or stenciled decorations or labels could also be added before or after the glaze was applied. Finally, the process of glazing varied depending on the type of glaze used. Salt glaze, for example, was applied by introducing the salt into the kiln during firing, causing it to vaporize and combine with the clay surfaces as they vitrified. Other glazes were suspended in water and applied directly to the dried clay before firing. Except for Bristol glaze, which was a commercially made product, potters often made their own glazes. This was particularly true of alkaline glaze, a substance made from sand, wood ash, and lime, that Edgefield District potters developed around the 1820s. Alkaline glazed-wares dominated Sand Hills pottery production up through the early twentieth century, when commercial slip glazes became widely available and affordable.

Finally, the kiln was loaded and the pots fired. Greer (1981:29-33) stated that folk potters built their own kilns beginning with making the bricks. They fired the bricks just enough to cure them for kiln construction and other shop structures. Southern potteries commonly used a kiln type known as a "groundhog," consisting of a long, low-lying structure with a firebox at one end and a chimney at the other (Joseph et al. 2004:123). Groundhog kilns were typically rectangular in shape with straight walls and an arched roof. They were usually sunk into the ground, leaving only the roof, firebox area, and chimney exposed. The earth sides therefore supported and insulated the structure.

Diagram of Groundhog Kiln  
Components (Espenshade 2002).

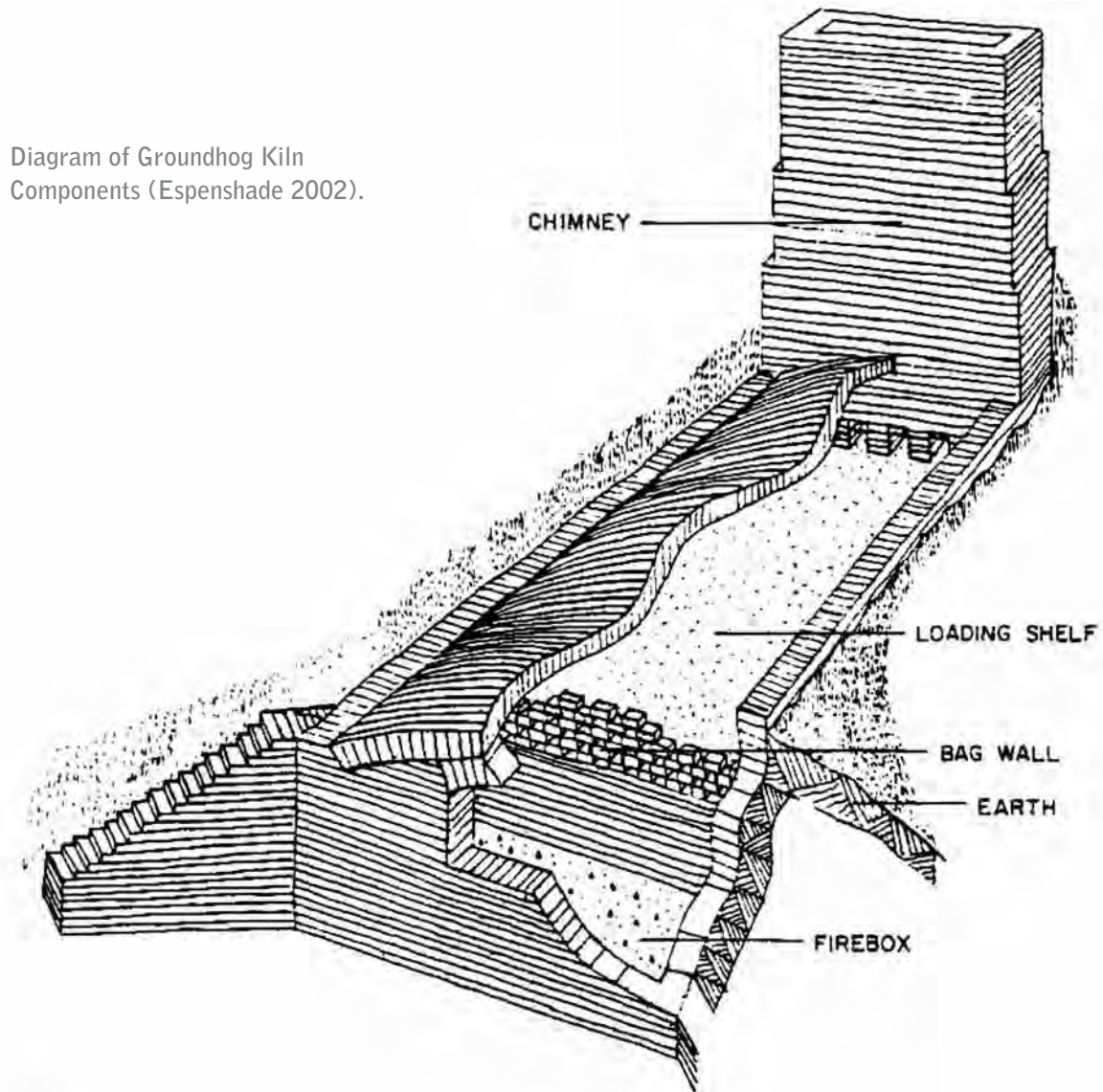

Kiln size could vary for a number of reasons to do with the type and quantity of pottery being produced, fuel sources, and tradition, among others. Typically, kilns ranged from 16 to 20 feet long and six to eight feet wide and included three principal functional areas: the firebox, the loading shelf, and the chimney. The firebox, located at one end of the kiln, measured three to six feet long and terminated with a wall at its back end. The floor of the firebox lay at one or two feet below the loading shelf, which began at the top of the firebox wall and extended inward toward the chimney. Typical examples measured 10 to 12 feet long. Chimneys measured three to four feet wide and contained one or more flues (Espenshade 2002:184, 189).

The firing process called for certain skills and considerable experience to achieve success. Technique was required just to load the kiln in a way to ensure that everything fit and received adequate exposure to the heat. The process became more elaborate as kilns grew taller and objects could be stacked. A group of

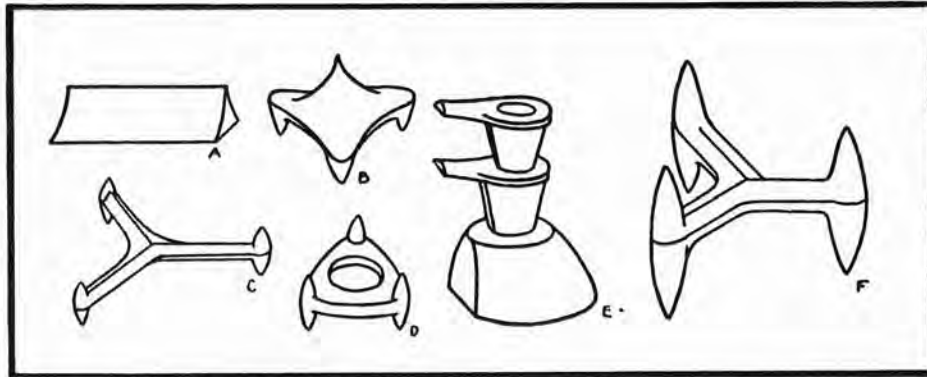

A



Jug stacker in position.



Stacker jug and jar in position.

B

Kiln Furniture Used to Fire Pottery and Diagrams Showing its Use. At a rural pottery, the furniture would probably be handmade and less formal.

A. Kiln Furniture (Rhead 1910).

B. Arrangement of Pottery in the Kiln Using the Kiln Furniture (Greer 1981).

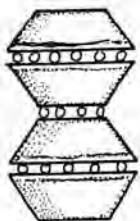

Mouth to Mouth and Bottom to Bottom stacking



Hanging Stacking of Wide Rimmed milk bowls

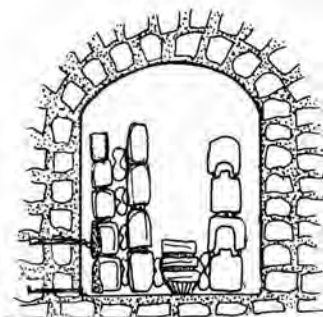

Stacking in an Upright Kiln

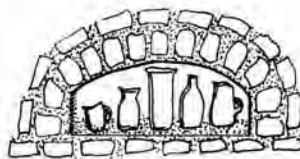

Stacking in a low Groundhog Kiln



clay forms known as “kiln furniture” assisted the process. These included various clay coils, spools, patties, and separators, made in advance or as needed, which kept glazed surfaces from touching one another and fusing as well as allowing efficient heat circulation.

To fire the kiln, the potter first raised the heat slowly to drive off any remaining water in the clay, including the water molecules bonded to it. Wood was the traditional fuel, although coal, gas, and electricity later came into use. Once the water was eliminated the heat was raised quickly by constant stoking. If using salt glaze, the potter introduced it to the kiln at this time. Test pieces (specially made ceramic objects known as “draw trials” [Bowen and Carnes 2002:205]) were withdrawn from the kiln to check the firing process. Once the potter was satisfied, the stoking was stopped and the firebox was sealed along with the chimney and any other openings. The kiln cooled over the next several days before being opened and unloaded.

In summary, the essential features of pottery making consisted of mining the clay, weathering and rinsing it, mixing it, throwing pots, making and applying glaze, and firing. Except for clay mining, most of these activities took place inside and around the potter’s shop. Most often the shop consisted of a wooden building containing separate areas for preparing the clay, the wheel, drying, and glazing. Aspects of the preparation process would also take place outside the shop. For instance, the weathering and evaporation areas would be outside. The pug mill would also be outside, particularly if it was animal-powered. A separate shed might also be provided for drying the vessels. Finally, the kiln was located outside the shop, but might be under a shed to provide some shelter from sun and rain during the loading and firing process. A waster dump usually formed near the kiln where rejects were discarded.

Essential Features of a Rural Stoneware Manufacturer. The pugmill and workshop are to the right and the kiln is in the center background. Note also the extensive storage areas for fired and dry pottery as well as firewood (far left). Hewell Pottery, Georgia, Unknown Date (Burrison 1983).





Archaeologically, features that might be expected with pottery making sites include the clay washing and evaporating areas, the potter's shed, the kiln, and a waster pile for manufacturing rejects. Many of the tools potters used were wooden and so might not be found archaeologically. However, kiln furniture should be expected. Archaeological study of potteries suggests that kilns and waster dumps are the most common features at these sites (Joseph et al. 2004:125).

## DISTRIBUTIONS AND RESEARCH

No potteries have been identified at any of the installations covered by this study. Although archaeological sites reflecting potteries have been identified in the Carolinas and Georgia, statewide GIS data was available only for Georgia. Plotting the 12 recorded sites in the state indicated that all of them are in the Piedmont and Sand Hills regions. This result was generally compatible with Burrison's (1983:114) map of 400 known folk potters in Georgia, which shows most potteries in these regions with concentrations in Barrow, Fulton, Hall, Pike/Upson, Paulding, and White counties in the Piedmont, Washington County in the Sand Hills, and Crawford County at the Sand Hills-Piedmont interface. Based on the data from Georgia, there is a potential for identifying numerous archaeological sites related to traditional pottery manufacturing. Burrison's map, however, suggests that only the Muscogee County sections of Fort Benning might contain any.

Baldwin (1993) provided information about pottery distributions in South Carolina. The Edgefield District was the nucleus of stoneware manufacturing in the state. Baldwin stated that one district potter, Abner Landrum, moved to the Columbia area in 1831 and by 1850 had established a pottery in the Sand Hills east of the city, becoming the only known Edgefield-tradition shop in the Richland District prior to the Civil War. After the war, additional shops opened in the area around Columbia, although pottery making never become a significant industry here (Baldwin 1993:67, 70, 119).

North Carolina did not have any significant pottery-making centers in the Sand Hills. Although clay deposits existed along the Cape Fear, these were considered inferior to the clay available in the Piedmont. However, two potteries were known to have operated in Fayetteville. Gurdon Robins opened the first of these around 1820. The firm was short-lived, however, and did not lead to any sustained pottery industry in the Sand Hills. In 1880 E.A. Poe of Fayetteville made the second attempt at establishing a commercial pottery in this area. The pottery was a sideline to Poe's principal business, brickmaking, and lasted only few years (Zug 1986:27-32, 34). No potters are known to have operated inside present-day Fort Bragg.

It is possible that undocumented small potteries might be present in any of the installations covered by this study. Fort Bragg seems the least likely to have any potteries, however, given that the North Carolina Sand Hills never had a significant historic pottery tradition.

Prior archaeological work at rural pottery making sites has mostly consisted of survey and identification. The surveys and test excavations that have been conducted, however, provide a basis for generating further research directions and thus assessing historical significance. Three studies that are noteworthy for this purpose were published together in a volume of *Early Georgia*. Jordan's (2002) study focused on finding the archaeological remains associated with the pottery-making center in Washington County, Georgia, one of the state's earliest centers of alkaline-glazed stoneware (Burrison 1983:122). Jordan identified four potteries and began working out some aspects of the structure and content of this type of site. Further, Jordan was able to distinguish the products of specific potters, which had the potential to illustrate the relationships between potteries as well as between individual potters and broader traditions. Finally, Jordan provided an assessment of survey techniques necessary to locate pottery sites, concluding that because the archaeological manifestations of these sites are often small and discrete, surface collection and wide survey intervals are not always appropriate for finding them.

Espenshade (2002) investigated a single site, the Sligh Pottery in Paulding County, Georgia. Here, test excavations dealt with a groundhog kiln and waster dump. The investigations identified evidence that the pottery was increased in size, in the 1870s, in an effort to operate at a larger scale and increase output. Manifestations of the expansion included building a larger kiln and switching to commercially available Albany slip glaze, while archival sources indicated the labor force also grew. The study also produced a model of ideal kiln sizes by traditional southern potters and speculated on aspects of technology, labor, and business practices. Of note, the study found that after the kiln was made bigger, the number of manufacturing rejects increased, suggesting that the potters had difficulty operating and controlling the new facility. This led to the conclusion that kilns had to remain with certain size limits at folk potteries to function efficiently and productively.

Bowen and Carnes (2002) also focused on a single site, the Rolader Site in Fulton County. While presently located in an urban area, historically the pottery's setting was a rural district on the outskirts of Atlanta. The objective of this study was to identify locally made pottery for comparison with products imported from outside the area and determine popular vessel forms. The outcome of the study tended to emphasize issues of corroboration with archival sources, but also contributed information on site structure and content, as well as on the products of this particular pottery. Another finding was the greater production

of unglazed wares, possibly representing flowerpots, during the later stages of the pottery's life. This switch might have reflected several historical developments, including the closing down of commercial distilleries and the decline in home dairying, which were important consumers of ceramic jugs, pans, and other containers. As urban and suburban Atlanta took over rural neighborhoods, potters found markets for new kinds of products oriented toward suburban gardeners.

Steen (1994) conducted a series of archaeological surveys in the Edgefield District, South Carolina to identify sites. He also performed limited excavation and artifact analysis. Results of this study, which described detailed examination of eight sites during 1987 and 1993-1994, included descriptions of the wares produced by different potteries; the first documentation of alkaline glazed grave makers; and investigations of a factory established by northern immigrants engaged in refined ceramic production rather than the traditional local products.

Joseph, Hamby, and Long (2004:127-128) presented research priorities for pottery making sites in Georgia and these have implications for the Carolinas as well. First, they recommend the development of reconnaissance level inventories of sites reflecting major pottery production centers. Steen (1994) and Jordan (2002) began this type of work with their studies in the Edgefield District and Washington County. Inventory work should also include the production of maps showing the locations of important site elements, such as the kiln and waster dumps. These features may not be readily apparent, however, and might require specialized survey techniques that combine archival sources, local informants, and limited excavation (Bowen and Carnes 2002; Jordan 2002). Additional information to collect from these sites includes the type and dimensions of the kiln, attributes of its construction, and the contents of the waster dump.

Another topic deals with different ceramic-making traditions. While Georgia and South Carolina potters shared many traditions dealt mainly with alkaline glazed stoneware, North Carolina pottery traditions had several different influences. A topic for archaeological study, then, would be to examine how and where these different traditions appear at pottery making sites and how different traditions influenced one another.

Archaeologists working at pottery sites can also investigate chronological changes to individual sites, as Espenshade (2002) did at the Sligh Pottery, and at regional scales. Specific issues to consider include how did potters respond to changing markets and new materials (e.g., glazes).

A final research topic involves looking at the wares produced by potters in the Sand Hills and adjacent regions recovered from non-pottery making sites. Carnes-McNaughton points out that Sand Hills' residents were customers of the local and regional potters, who personally sold their products to houses and stores. At Fort Bragg, archaeologists investigating domestic sites have found ceramic assemblages consisting largely of salt-glazed stonewares produced by the Webster brothers in Fayetteville, the Craven Pottery in Moore County, and potteries in Chatham County (Carnes-McNaughton, personal communication, 2009). Therefore, sites at the installations where locally made stonewares and earthenwares are recovered can provide information about marketing, consumption, and distribution of these wares.

## “MANUFACTURED AT MANY LOCALITIES”: BRICKS

Brickmaking was an important, although mostly small-scale and local industry in rural areas. Except for special types, brickmaking was oriented toward providing building materials for limited markets (Van Tassel and Bluestone 1939:1; Dergane 1976). Common brick, the cheapest to manufacture, came from locally available, low-grade surface clay. Manufacturing could take place in almost any location because the chief ingredients of brick—clay, sand, and water—occurred nearly everywhere and the process did not require permanent structures or facilities. Thus, bricks were often made near the location they would be used, whether in cities, towns, or individual farmsteads and plantations (Bishir et al. 1990:201). Also, the low value of the product combined with its weight, made shipping costs prohibitive over long distances, which discouraged the development of larger centralized manufacturing centers (Smith 1916:266). In the Carolinas and Georgia, brickmaking followed this pattern of smaller brickyards serving local markets, although around the turn of the nineteenth century, large-scale brick manufacturers also operated in some locations as well. The size of the industry and individual producers was primarily related to the development and requirements of the local markets. For instance, the need for fireproof tobacco warehouses in the North Carolina Piedmont sparked a boom in the local brick industry. The Cherokee, Sanford Brick, and Lee Brick plants in Sanford, Lee County, might have been among these (Carnes-McNaughton, personal communication, 2009). After the Civil War, these kinds of requirements also spurred considerable experimentation and several North Carolina mechanics patented new devices for making bricks (Bishir et al. 1990:233-236). Brick manufacturers also sometimes produced other clay products, including pottery and terracotta (Ladd 1898). For example, Near Fort Bragg in North Carolina, the E.A. Poe Brickyard operated in Fayetteville from before the twentieth century to around 1943, and turned out both bricks and pottery (Ries 1897; Carnes-McNaughton, personal communication, 2009).



Brickmaking procedures and technology are well understood. Ries and Kümmel (1904:223-241), Gurke (1987:3-38), and Weldon (1990) provided good descriptions of the process, which involves five principal steps: mining clay, mixing and preparing the clay for molding, molding or shaping the bricks, drying, and firing. Sorting and grading the fired bricks constituted a final procedure in readying the bricks for sale (Gurke 1987:4). The sequence of production remains largely unchanged, although it is now almost entirely mechanized, a trend that began around the mid-nineteenth century when various mechanical devices were developed and introduced into the process. Most advancement toward mechanization was applied to the mining, mixing, and molding of clay as well as conveying materials through the brickyard. Improvements to firing mainly involved refinements to kiln design while drying saw the application of artificial heating systems. Mechanization of brickmaking chiefly took place in urban-based brick plants while operations serving smaller local markets tended to adopt new equipment and procedures less systematically and consistently (Van Tassel and Bluestone 1939:1). Nevertheless, by the turn of the twentieth century rural brickyards routinely used mechanical equipment for mixing and molding.

## MINING

The mining or 'winning' of clay was the first step in the brick manufacturing process. The methods for this procedure varied depending on the geological, topographic, and economic features of the clay deposit. The thickness and nature of overburden, depth of clay deposit, distribution of impurities in and around the clay, and location of the deposit in relation to the plant and market affected decisions on where and how to extract the clay. The four chief ways of mining clay were surface or open-pit mining; underground mining; hydraulic mining, which involved directing high-powered streams of water at



### MINING BRICK CLAY

A. Conveyor for Lifting Clay to the Upper Story of the Brick Plant. Waynesboro, Mississippi, Before 1910 (Logan 1908).

B. Clay Pit with Track and Car. Biloxi Area, Mississippi, Before 1910 (Logan 1908).

### Mule-Powered Ring Pit.

This photograph illustrates several aspects of traditional brickmaking. The ring pit is at the left. The man at the table in the center is molding bricks by hand while helpers carry them to the drying yard seen behind him.

In the background, partially dry bricks are stacked under cover. North Carolina, 1908 (Randolph County Library).



the base of a clay bed to undermine it; and dredging, performed near large bodies of water. Surface and underground mining were conducted by hand during the nineteenth century, although horse-drawn scrapers were also used. Steam shovels and other mechanized processes for excavating clay and moving it to the brick plant ultimately replaced these methods (Gurke 1987:4-6).

Traditional brickmaking required that clay be excavated well ahead of its eventual use to allow it time for weathering before molding. This process typically involved exposing the clay to the elements, usually over the winter, which broke down large chunks, as well as washing out soluble salts. Frequent turning of the clay allowed larger particles and impurities to be removed (Ries and Kümmel 1904:223; Gurke 1987:7; Weldon 1990:6).

### TEMPERING

The next production stage entailed tempering the clay with sand, water, and possibly other materials to adjust its plasticity and firing qualities. Once added, these materials had to be thoroughly mixed into the clay. Historically, the simplest method was to have workers or animals trample the clay and additives until they were mixed. Soak pits were another method and consisted of wood-lined pits set up behind the molding machines. Clay, water, and sometimes other additives were placed in the pit and allowed to soak overnight to soften the clay. The soaked clay was then loaded into the molding machine, which mixed the clay and additives. Another method for tempering was the ring pit, a circular ditch into which clay, sand, and water were placed. A large metal wheel driven around the ring by horse or steam power mixed the ingredients (Ries and Kümmel 1904:225; Gurke 1987:7).

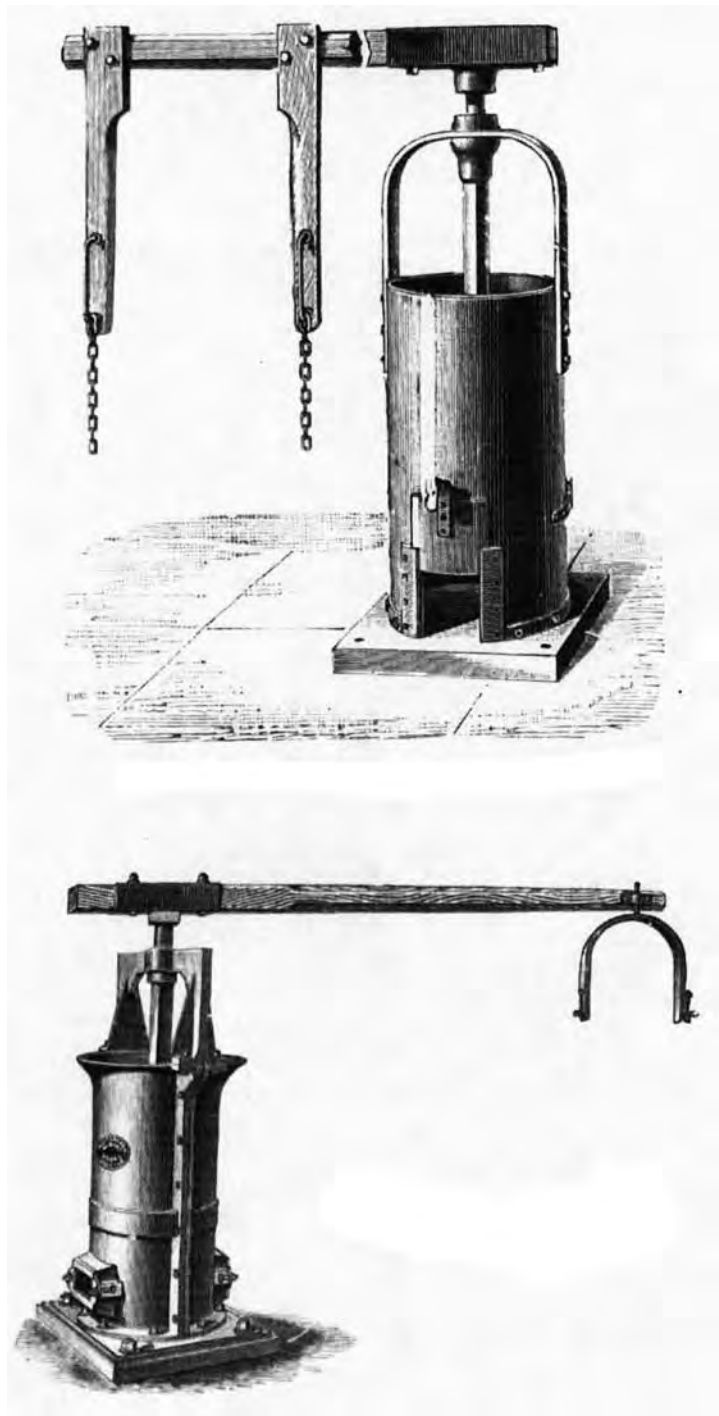

Varieties of Vertical Pug Mills. These examples were powered by horses. The mixed clay emerged from the opening at the mill's base (LeFevre 1900).

Pug mills emerged as the most common method for tempering clay, and continue in use to the present. The first mechanical devices applied to brick making, these consisted of either a wooden tub or trough with a bladed shaft. As the shaft turned, the blades cut and mixed the clay, and in horizontal versions they moved the clay forward to the discharge end (Ries and Kümmel 1904:225-226; Gurke 1987:10).

## MOLDING

After tempering the clay was shaped into bricks. Three principal methods were employed in the United States for molding bricks: soft-mud, stiff-mud, and dry press. The soft-mud technique entailed adding water to the clay until a soft consistency was achieved. At this point the mixture was placed in wooden molds for shaping (Ries and Kümmel 1904:226-227). Soft-mud bricks can be made by hand or machine. Hand-made bricks were prevalent until the mid- to late nineteenth century, but persisted into the twentieth



Equipment for Hand Molding Bricks. A two-piece mold is in the center with a molding table to the left. The sandbox supplied sand to keep the wet clay from sticking to the mold. Bricks at right are set out to dry (LeFevre 1900).

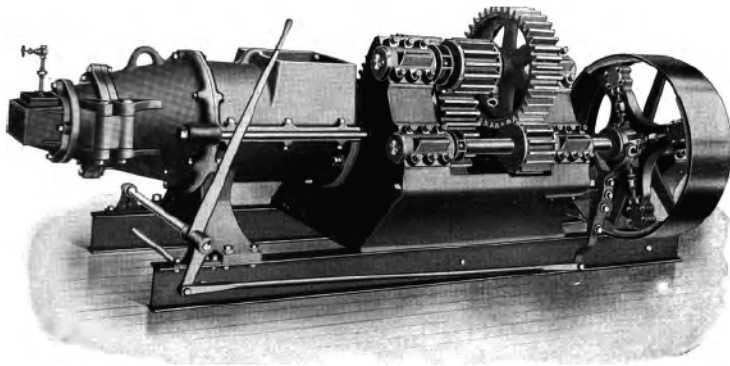
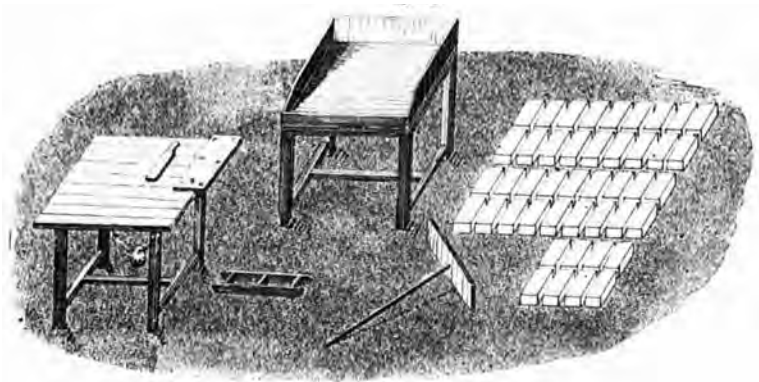

century. Machines for making soft-mud bricks mechanically forced the clay into wooden or metal molds that had to be inserted and removed by hand.

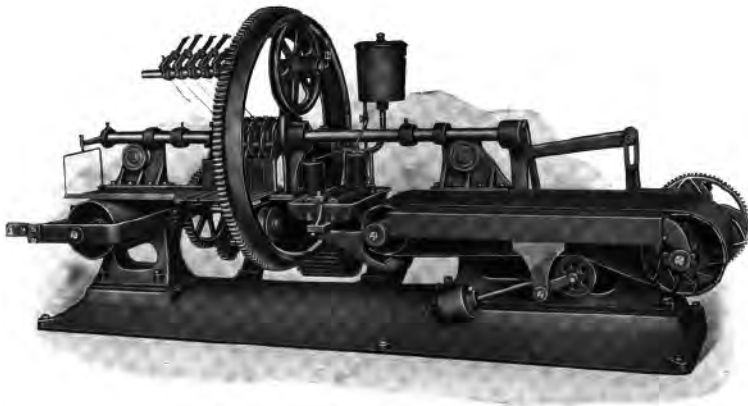

The stiff-mud technique exhibited several differences from the soft-mud process. The clay contained less water to produce a firmer raw material. The pug mill is attached to the molding machine, consisting of a tapering cylinder. Inside the machine, a horizontal bladed shaft with a screw at the narrow end moved the clay forward and extruded it through a die, which compresses the clay into a long bar or column. This column

Machines for Molding and Cutting Bricks Using the Stiff-Mud Process (Logan 1908).

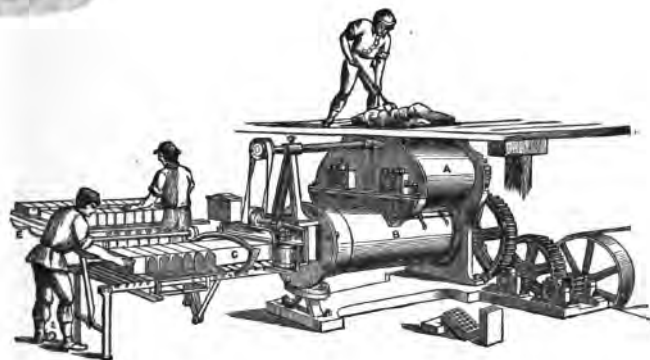

The Stiff-Mud Brickmaking Process (MacDowell 1907).



moved to a cutting table where it was sliced into bricks by a series of wires on a frame (Ries and Kümmel 1904:228; Gurke 1987:21).

Like those produced by the soft-mud process, stiff-mud bricks might require extra shaping to sharpen their edges with a repress machine. Semi-dry or green bricks were placed in the machine and pressure was applied to produce smoother bricks with sharper edges. These bricks were more expensive due to the extra labor. The process also had the advantage of allowing the company's name to be impressed on the bricks (Ries and Kümmel 1904:232; Gurke 1987:22).

In the dry-press process, a charger deposited a measure of very dry clay and additives into a mold, which was then subjected to pressure between a plunger above and the mold pushing upward. The process generated bricks with sharp edges and smooth sides. Further, the limited use of water reduced the drying time, and the resulting brick was extremely hard (Ries and Kümmel 1904:230-232; Gurke 1987:22-23).



#### BRICK DRYING

A. Open Yard Drying. Bricks are being turned on their edge after an initial period of drying. Southern Mississippi, Before 1910 (Logan 1908).

B. Bricks in Hacks under Individual Roofs. Southern Mississippi, Before 1910 (Logan 1908).

C. Hacks Drying in a Shed. Gwinnett County, Georgia, 1910 (Georgia Archives).

## DRYING

Drying was most important with soft-mud and stiff-mud bricks. Dry-press bricks contained little excess moisture and went directly to the kilns. Drying was a critical step. Incompletely dried bricks could be damaged during firing, while over-dry bricks could fall apart when handled. Drying had to be slow to prevent natural shrinkage (Gurke 1987:24).

Drying could take place in open yards, covered yards, on pallet racks, in tunnel driers, or on drying floors. Open yards were most common in soft-mud brickyards and consisted simply of smooth flat floors of earth or brick. The newly molded bricks were placed on this surface in a single layer, and after a day or so, the partly dried bricks were piled into double rows several courses high. Open yards had the disadvantage of requiring considerable space and exposing the bricks to rain. Covered yards essentially consisted of large sheds that provided protection from rain (Ries and Kümmel 1904:233).

Pallet driers were covered frames for holding the pallets on which the bricks were placed. They were common at soft-mud yards and some stiff-mud operations where their cheapness, large capacity, economy of space, and protection from rain made them popular. A disadvantage of these three techniques was that they became less effective in cold or humid weather. Ideal conditions for drying bricks were dry, sunny, and windy weather (Ries and Kümmel 1904:233).

Drying tunnels could be used year-round. The method involved placing the newly molded bricks on cars that ran through heated tunnels. Some brickyards had several tunnels side-by-side to increase capacity. The green bricks entered the tunnel at the cooler end and gradually progressed to the warmer end, where they were removed. The process took between 24 and 48 hours to complete. Options for heating the tunnels included running hot air (heated by fire) through them; using steam pipes; or drawing exhaust air from the kilns (Ries and Kümmel 1904:233-234).

## FIRING

The last stage in the manufacturing process was firing, which caused changes in the physical and chemical properties of the clay and converted it to a solid, rock-like mass (Ries and Kümmel 1904:234). The process began by stacking the bricks in a particular way to ensure proper firing. Burning started by slowly raising the temperature to force out the water remaining in the brick without causing rapid shrinkage. When the steam ceased to emerge from the kiln, the fires were raised to a red heat as the bricks entered the



dehydration period, which dispersed the water that was chemically combined with the clay. Oxidation also occurred at this time and combustible materials in the brick burned away (Gurke 1987:28).

Vitrification completed the firing process. When oxidation was finished the kiln was sealed, causing the clay to soften and the pore spaces to fill. Larger grains adhered or melted together. The process ideally produced the maximum amount of shrinkage with a minimum of deformation. Once the kiln reached the proper temperature (a rate determined through time and experience), the fires were shut off and the bricks allowed to cool over 48 to 72 hours. Cooling too rapidly could cause the bricks to become brittle or to crack. The overall timing of the firing process varied depending on type of kiln, with primitive up-draft kilns requiring up to seven days, while modern tunnel kilns finish the process in around 40 hours (Gurke 1987:28-29).

Brick Kiln Interior  
Showing Technique of  
Stacking Bricks for  
Proper Firing. Unknown  
Location and Date  
(Courtesy of Matt  
Matternes).





#### “SCOVE” KILNS

A. Kilns Built under Sheds and Covered in Burned Bricks and Daub. Covington County, Mississippi, Before 1910 (Logan 1908).

B. Workers Firing a Scove Kiln through Arches at Its Base. Quincy, Florida, Unknown Date (Florida State Library).



Gurke (1987) divided kilns into two principal types: periodic and continuous. Periodic kilns required the bricks to be loaded, fired, and then unloaded. Continuous kilns included types where the fire moved through the kiln and ones where the bricks moved past a stationary fire. Downdraft and up-draft kilns describe the direction that hot gasses flow within the kiln, and could apply to either periodic or continuous types.

Kilns could also be permanent or temporary. Temporary kilns (“scoves”) were made from the dried green bricks stacked to form a structure with arched firing tunnels at the base. After the bricks were stacked to between 35 and 40 courses, the exterior was covered with burnt bricks and daub and fires were built in the arches. After firing, the kiln was dismantled (Gurke 1987:29). Another type of temporary kiln known as a “clamp” had some differences from a scove, but these differences might be difficult to distinguish archaeologically. The difference was that a clamp had permanent brick walls forming at least three sides of the kiln. If a fourth wall was present, it was left with an opening to load the bricks. Openings were also built into the sidewalls to provide access to the firing tunnels. The bricks were fired in this structure by stacking them in the same way as with a scove. The permanent walls of clamps helped retain heat and provided greater control over the firing. Clamps did not have permanent roofs, however, and the top of the brick pile was covered in previously fired bricks and daub.



Clamps and scoves were periodic updraft kilns in that the heat rose from the bottom and moved upward and out of the kiln. Updraft kilns provided uneven heating and the quality of the final product varied. It was common for a quarter of the burn to be defective (Gurke 1987:32).

Deficiencies in these types of kiln were solved with the development of the down-draft kiln. In these structures, hot air from the fires did not immediately touch the bricks, but instead was channeled up through the kiln walls via systems of flues and was forced downward through the bricks and out through the floor. This system used permanent structures and provided a more even distribution of heat. These kilns were built in round "beehive" or rectangular forms (Gurke 1987:32).



Round "Beehive" Kilns at a Large Brick Plant, Florida, Unknown Date. The same construction would be used at smaller rural brickyards. (Florida State Library).

Continuous kilns were permanent structures containing as many as 16 chambers connected within an oval or circular footprint. Each chamber was loaded and unloaded as in periodic kilns, but the kiln could be in continuous use, the heat of one burn being reused over and over. While some chambers were loaded, others could be fired, while still others could be cooled, and the remainder unloaded. Another kind of continuous kiln was the tunnel kiln, which was similar to a tunnel dryer and consisted of a long low passageway just large enough for a steel car loaded with 1,000 green bricks. The car ran on rails and as it progressed through the kiln, the various stages of burning were applied to the bricks (Gurke 1987:32-34).

Finally, the bricks were sorted and graded, less a manufacturing procedure than a marketing one, as the bricks were classified according to their physical qualities and potential use. The classification of bricks generally spanned a continuum from the soft, under fired bricks to

the most vitrified specimens. The names used to describe bricks after firing reflected their quality and, as Gurke (1987:35) remarks, indicated how the brick maker thought about his products.

## BRICK FACTORY COMPONENTS

Brick factories contained several elements that leave archaeological signatures. A typical rural brickyard included a clay source, mixing and molding areas, drying areas, and kilns. Auxiliary facilities could include trackways or rail lines for moving materials around the yard, drains, storage areas, and waste disposal areas. Archaeological investigations most often identify kilns. Even temporary kilns, or clamps, leave characteristic linear brick features alternating with empty spaces that represent the firing tunnels.

Other features commonly identified at brickyard sites are the clay pits, which are large and obvious landscape features. Facilities such as those associated with mixing and molding can be identified if machinery and equipment have been left at the site. Alternatively, machine mounts of brick or stone can represent the locations of these activities. At brickyards producing handmade bricks, obvious archaeological remains of molding would not likely be found because these did not require substantial structures. Rectangular soak pits or circular ring pits for mixing clay might be present, however. Drying areas consisted of open yards that might have beaten or compact earth floors, brick floors, or rows of postholes representing the drying racks. Artificial drying might leave structural remains or subsurface features, such as flues. Waster dumps and drainage features would also produce distinctive archaeological remains.

## RESEARCH

Although all three states covered by this study contained brickyards, few have been documented archaeologically and none have been recorded at any of the six DOD installations. Moreover, archaeological sites identified as brickyards have often been examined only at the survey level and have not been conclusively determined as to function. For example, of six “brickyard” sites found in the Georgia Archaeological Site Files—statewide—three were not checked archaeologically but were projected on the basis of historical documents. Two of the others did not contain any clear-cut evidence of brickmaking; rather, they contained nondescript features with brick. Only 9BL249 was unequivocally described as a brick kiln. Brickyards are a little known archaeological resource in the study area that has considerable potential for research.

In general, brickmaking was a local industry. In some instances a temporary manufacturing operation was established at a construction site to produce building materials for a specific project. Additionally, brickyards could be permanent but operated on a relatively small scale to serve a local market. Such yards might be located in either urban or rural areas. Finally, large urban brick factories existed. These were typically in cities and associated with general industrial districts. For this study, smaller permanent and transient brickyards are of interest.

Archaeologists dealing with bricks and brickmaking have mostly focused on the remains of kilns, which usually comprise the most obvious and only remaining features of a brickyard. Perhaps because evidence of the mixing, molding, and drying processes are not as apparent, these activities are not addressed. Consequently, archaeology of brickyard sites tends to yield considerable information about the kilns and firing but little else (Botwick et al. 2009). Additionally, bricks are often described but not analyzed with an eye toward identifying clay mixing, manufacturing technique, or other topics (Gurke 1987), although this is beginning to change as archaeologists look at bricks as artifacts with a potential for identifying distribution networks (Feister and Sopko 1996) and understanding the development of historic landscapes (Scarlett et al. 2006).

Brickyards in the Sand Hills region have a significant potential for studying aspects of industrial history and development. Analyses can focus on the products and processes of brickmaking itself to better understand the scale and quality of individual operations or those of the region. Additionally, looking at the process from a regional and landscape perspective can be informative about how this industry impacted the land and how it related to other economic activities. For example, Wayne's (1997) study of antebellum brickyards in the South Carolina rice country showed how brickmaking yielded profits from land with limited agricultural potential.

Another topic worth considering is the brickyard labor force. Archaeologists studying bricks and brickmaking often do not address workers or the organization of labor except in mentioning their job tasks and relative skill levels (Gurke 1987:15). Examining brickyards, however, and delineating their layout and organization can provide insight into their nature as workplaces and therefore can provide new information about the conditions faced by employees.

More specific topics to address in dealing with the archaeology of brickmaking in the Sand Hills include first developing a database of sites. At this point none have been documented and it is unknown if any existed at the six DOD installations. Second, if brickyards are present, efforts should be made to look beyond

the kiln and other obvious features, such as the clay pit. Numerous activities took place at a brickyard and evidence for them should exist. At a minimum, their locations can be projected. Reconstructing the layout of the brickyard would yield important information about the organization and use of space. A third topic to address concerns the technology in use at the brickyard. Specifically, how was clay mixed and molded, how were bricks moved around the yard, and what kind of kiln was in use. These topics have implications for understanding the scale of an operation and developing data for determining the general procedures used in a particular region.





# 5

## “OTHER INDUSTRIES THAT MAKE A GOOD SHOWING”

### BLACKSMITHING—THE WORKING OF IRON AND STEEL IN EVERY BRANCH OF FORGING

Blacksmith shops were regular features of larger plantations, small towns, and communities in the rural south. Small shops might also be present on individual farms, although these were intended for repairing and maintaining farm equipment rather than production and specialized work (Cobleigh 1914:269-270). This study is concerned with hand blacksmithing, which turned out wrought iron goods. Factory production of iron products is not addressed here, as this was not a characteristic industry in the rural Sand Hills. The manufacture of iron in bloomeries or blast furnaces is not addressed here for the same reason.



Blacksmith and Assistant  
or Apprentice in the Shop.  
Unknown Location and Date  
(New York Public Library).

Hand blacksmithing persisted into the twentieth century. Blacksmiths produced and repaired a variety of tools, implements, and building materials. Even as the work became more industrialized and exacting, with factories turning out many items, blacksmiths remained important and found general work as farriers, wagon-wrights, and repairmen.

The development of the Bessemer process for producing steel, combined with the spread of the automobile, eventually brought an end to widespread commercial hand blacksmithing. Steel production entailed numerous changes in the technology and techniques of metal working as well as the way the processes were organized. Also, all the tools and building materials once made by blacksmiths could be cheaply mass-produced and distributed. Finally, once automobiles replaced horses and wagons, blacksmiths lost a major sector of their work (Light 2007:86-88).



The basic task of blacksmithing was to produce tools and implements of iron and steel. Until the late nineteenth century, steel was rarely used, but it ultimately supplanted iron as the principal forging material. Iron and steel came from the furnace in a variety of shapes and sizes, bars and rods being the most useful to blacksmiths. These came in several cross-section shapes and smiths selected the shape most similar to the intended final product. Additionally, blacksmiths made extensive use of scrap metal, and acquired it by saving what they produced in their own shops as well as soliciting it from neighbors and customers (Light 2007:69).

A blacksmith's shop was arranged to facilitate various activities. Typically, they measured 25x25 feet and were usually one story. They normally contained few windows because smiths needed a certain amount of darkness to see the glowing colors of heated metals. The door was usually large enough to admit a horse and large equipment (Light 2007).

The shop interior contained four principal categories of space devoted to work, storage, refuse, and social/business activities. Work focused on the forge, usually a brick or stone

Blacksmiths Working on Horseshoes and Wagon Wheels. Unknown Location and Date (Courtesy of Matt Matternes).



Traditional  
Blacksmith Shop.  
Note the large entry  
and limited light  
sources. Madison  
County, Florida,  
1889 (Florida State  
Library).

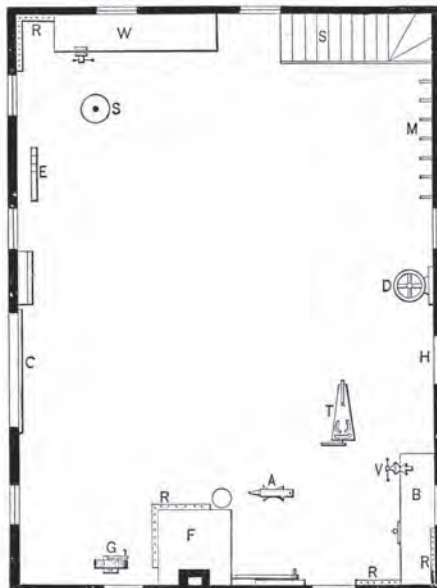

Plan of a Blacksmith  
Shop. The plan shows  
distinctive work  
areas. The forge ('F')  
and Anvil ('A') were  
the center of most  
work (Richardson  
1978).

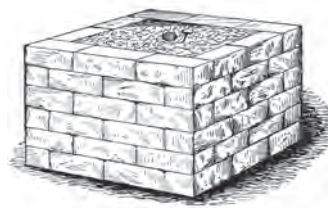

Idealized Forge  
(Richardson 1978).

Stand Forge  
(Richardson 1978).

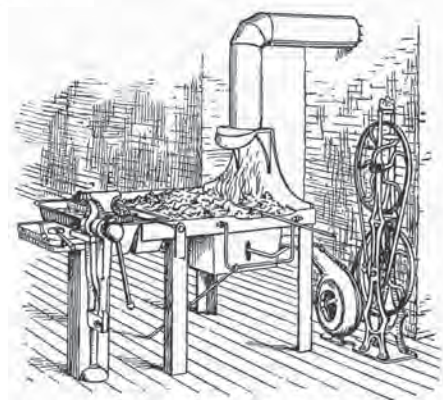





Arrangement of Blacksmith's Workspace. The anvil and forge are within a step of one another. Adjacent areas contain hand tools and raw materials. Vermont, 1937 (Library of Congress).



Detail of a Blacksmith Shop Showing the Anvil Base and Stand Forge with Blower. New Mexico, 1944 (Library of Congress).

structure with firebricks or sand at the top. The forge was usually waist high and had openings on one or more sides to allow access. Later examples consisted of iron pans mounted on legs. The forge might not possess a chimney; studies of southern blacksmith shops suggest that they were built with open gables or open but overhanging roofs to allow smoke to exit. The bellows was mounted to one side and the anvil was nearby, usually within two steps. The bellows might be mounted on posts or hung from the ceiling, while later blacksmiths might use hand-cranked blowers instead of bellows. The anvil was usually mounted on a stump or heavy post embedded in the floor. A slack tub, perhaps consisting of a half barrel set in a pit, was also nearby along with a workbench. The workbench was where certain detailed work took place and so was usually near a window to take advantage of the light. Storage areas contained tool racks, scraps for recycling, and fuel for the forge, although fuel might be stored outside to reduce fire hazards. The shop also contained a domestic space where the smith could have meals and social activities could take

place. Typically an informally arranged area, it might contain table and chairs that contrasted with the equipment and furnishings of the workspace (Coastal Carolina Research 1997; Light 2007:89-91).

Archaeological excavations of blacksmith shops in the South (Rotenstein 1986; McBride 1987; Coastal Carolina Research 1997) indicate features that can be expected. The principal archaeological elements of a blacksmith shop reflect the forge area, possibly the anvil location, the shop building, and waste deposits. The forge would most likely be marked by building rubble. At the Griswold shop in Mississippi, however, McBride (1987) found that the materials for the forge had been salvaged, leaving only a large shallow depression surrounded by an artifact concentration. The anvil location should be nearby by the

A

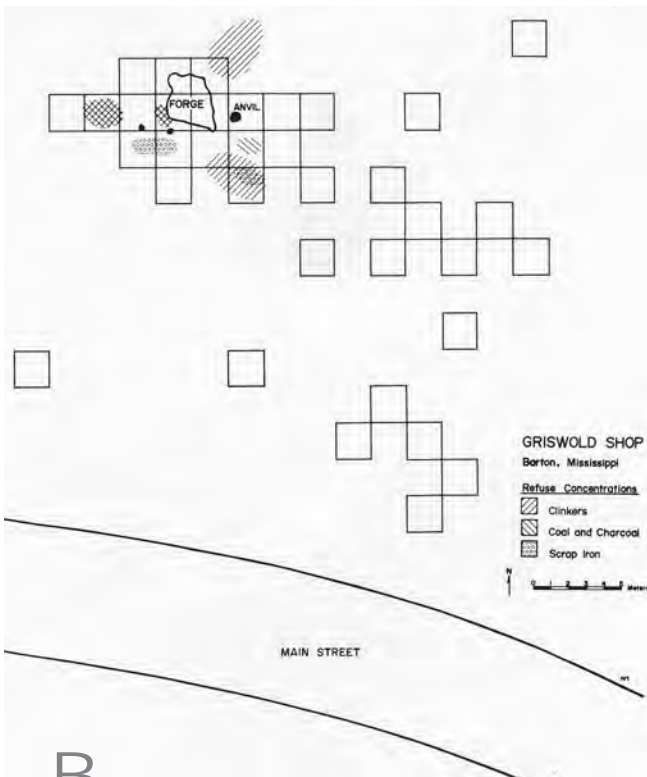

B

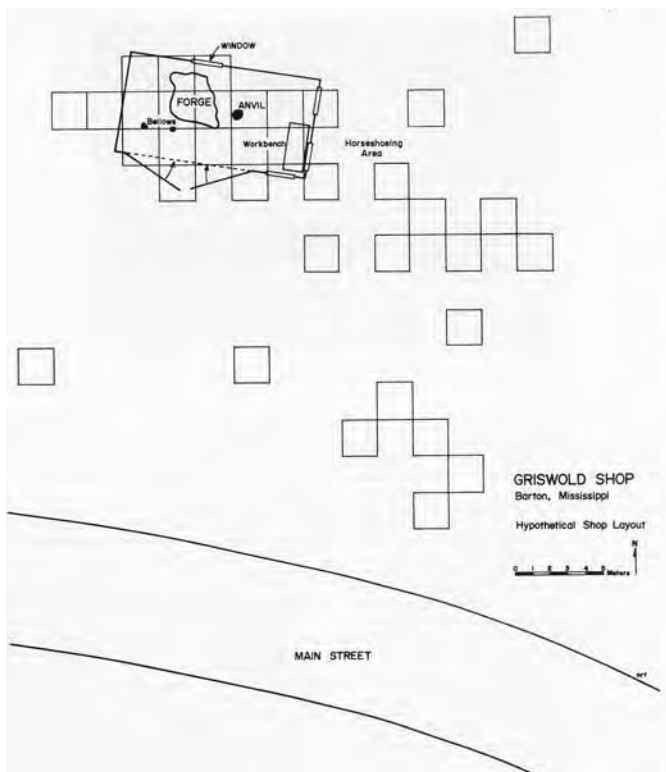

ARCHAEOLOGICAL REMAINS OF A VILLAGE  
BLACKSMITH SHOP (AFTER MCBRIDE 1997).

A. Refuse Concentrations at Griswold Blacksmith Shop Site, Barton, Mississippi.

B. Projected Shop Layout.

forge and most likely would be reflected by a large posthole. Typically, the anvil itself, along with any other useable tools or metal pieces, was salvaged. The presence of architectural remains depended on the type of structure, although postholes reflecting wall studs and floor joist remains have been reported (Coastal Carolina Research 1997). Refuse deposits could include fuel cleanings (coal and charcoal), manufacturing residue (slag, unusable bits of metal), and discarded items. Large tools and metal scraps would not necessarily be found, as these could be salvaged for use elsewhere.

Other features that might be present include various pits and postholes that could represent the bellows support, the slack tub, and fuel bins. Artifact patterns could also be informative with respect to interpreting site organization. For instance, McBride (1987:82) projected the possible location of a workbench based on window glass distributions. The area that Light (2007) called the domestic space should be reflected by the presence of ceramics, glass, and artifacts reflecting generally non-blacksmithing or work activities. Archaeological studies of southern smithies have not found such areas. McBride (1987:84-85) suggested that Light and others had

documented these kinds of spaces in northern shops, where the heat from the forge would not be too uncomfortable. In the south, the heat might have discouraged having domestic or non-work space inside the shop. Also, if the shop was located in town or near his home, the smith could leave for meals (McBride 1987; Coastal Carolina Research 1997).

## DISTRIBUTIONS AND RESEARCH

Only one blacksmith shop has been identified at the six DOD installations covered by this study. Site 9CE1289 at Fort Benning consists of a “house mound” associated with King Plantation. Shovel testing here produced 16 wrought iron artifacts that were interpreted as evidence of a blacksmith shop. The site was covered only by Phase I survey and, therefore, no further information was found to support this interpretation.

As with other site types covered in this study, regional distributions would be important to determine. The locations and spacing over large areas should indicate how rural blacksmiths served their communities and how large their service areas were. Blacksmith shops would be located near settlements, although this might be most applicable to the post-bellum period. Before the war, large plantations might have their own smiths. It is known that residential and community settlement patterns changed significantly after the Civil War. A worthwhile topic to study would be how the distributions and settlement patterning of blacksmith shops changed after the war.

Blacksmith shops in rural districts were expected to provide a range of services including tool manufacture and repair, horse shoeing, repairing vehicles, and other tasks. As discussed above, there were certain idealized principals around which shops were organized. Contemporary sources, however, indicate that personal preferences played an important role in how individual blacksmiths arranged their workspace (Casterlin 1914; Holmstrom 1904; Richardson 1889). As discussed above, moreover, archaeological studies of blacksmith shops in the south revealed differences with models developed on the basis of blacksmith shops in the north.

Joseph, Hamby, and Long (2004:134) discussed research topics that would be useful to address at individual blacksmith shops. These include recording the forge’s dimensions, materials, and style of construction. Also, features that can be related to various functional items and activity areas should be identified. They further recommend metal detector survey to locate areas where tools, scrap, and other metal materials were stored or worked on.

Identifying workspaces and discrete functional areas can provide information on what kinds of services individual blacksmiths performed. Presumably over broad areas, patterns could be discerned that might indicate aspects of rural blacksmithing. Other topics to address might deal with differences and similarities between antebellum and post-war blacksmith shops. Before the war, plantation blacksmiths were often African-American slaves, and therefore it would be worth comparing the assemblages and organization of their shops to those of white and free blacksmiths, who presumably had a greater degree of discretion in how they set up and operated their businesses.

Another issue that might be addressed is the source of raw materials used by blacksmiths in rural areas. As noted, they both purchased iron and steel stock from bloomeries and mills, as well as collecting scraps. Scraps were especially important sources of raw material before the mid nineteenth century (Light 2007:89). Metallurgical analysis might help identify the sources of metal that individual blacksmiths were drawing on for their shops. Across broad areas, distribution networks might be discernable.

## “ILLICIT DISTILLATION IS CONSTANTLY GOING ON”: STILLS AND LIQUOR DISTILLING

Distilling liquor was a common activity in the southeast and achieved an important place in southern history and folklore. Production of corn and other grain distillations could take place either in commercial distilleries or in smaller, illicit, operations producing moonshine.

From the early days of settlement, farmers routinely distilled grain surpluses because the resulting whiskey preserved better, was easier to transport, and obtained better prices. In fact, distilleries were vital means for turning excess crops into saleable commodities, especially in frontier areas and isolated rural communities where transportation was poor. Commercial distilling first flourished after the American Revolution, which disrupted the trade in rum and molasses. The repeal of the whiskey tax in 1802 caused whiskey, which was also cheap and plentiful, to drastically out-compete rum. The rise of whiskey was also aided by the immigration of Scotch, Irish, and Scotch-Irish distillers during the later 1700s. These immigrants came from regions with well-developed distilling traditions and experience. By the 1810s, commercial distilling had become centered in Kentucky, but other states, including North Carolina, possessed substantial distilling operations (Rorabaugh 1979:67-69; Tyrrell 1982:499, 505; Lender 1989:744). Much of the commercial whiskey production during the nineteenth century took place in numerous small distilleries, many of which were affiliated with gristmills (Becher 2000).



ESTABLISHED 1768.



KEEP CARD.

**IN THREE CENTURIES.**

Established in the 18th, covered every day of the 19th, and growing in popularity in this, the 20th, Century. That's the record of **The Old Nick Williams Whiskies**—133 years under the proprietorship of son, grandson and great-grandson of Col. Joseph Williams, the Revolutionary hero who began it when **quality not quantity** was their object. **No other such record in the World.** **No other such Whiskey in the World**—formula 150 years old. **Not a minute's headache in a barrel.** With our reputation to protect we will not ship it until passed through nine immense and densely packed filterers which makes it today the finest whiskey in America. You can buy whiskey, so-called, for less than we offer it, but you **don't get what you expect.** If you care nothing for your health, then use **medicated cheap stuff.** No brands on packages, billed as canned fruit or merchandise if you prefer. One, two, three and five gallon packages in jug department, and nothing less than one gallon shipped from it. In case goods nothing less than (12) twelve full quarts though they may be an assortment of

the varieties. A case is twelve quarts or twenty-four pints.

NAME OF GOODS.	Price per Gal.	Price per Qt.	Price per Case.	NAME OF GOODS.	Price per Gal.	Price per Qt.	Price per Case.
Rye, 10 years old...	\$1.70	1.25	15.00	Wheat, 6 years old....	3.00	.82½	9.00
" 8 " " " " "	3.85	1.04	12.48	" 4 " " " " "	2.50	.70	8.40
" 6 " " " " "	3.20	.87½	10.50	Sour Mash, 8 " " "	4.00	1.07½	12.90
" 4 " " " " "	2.70	.75	9.00	" 6 " " " " "	3.00	.82½	9.90
" 3 " " " " "	2.40	.67½	8.10	Peach Bd'y, 10 yrs. old	7.00	1.82½	21.90
" 2 " " " " "	2.20	.62½	7.50	" 4 " " " " "	3.50	.95	11.40
" 1 " " " " "	2.00	.57½	6.90	" 1 " " " " "	2.50	.70	8.40
Corn, 10 " " " " "	3.75	1.01½	12.18	Apple " 10 " " "	6.00	1.57½	18.90
" 8 " " " " "	3.10	.85	10.20	" " 4 " " " "	3.00	.82½	9.90
" 6 " " " " "	2.50	.70	8.40	" " 1 " " " "	2.00	.57½	6.90
" 4 " " " " "	2.30	.62½	7.50	Blackb'ry Brandy.....	1.00	.34	4.00
" 3 " " " " "	2.00	.57½	6.90	" "extra fine	1.80	.52½	6.30
" 2 " " " " "	1.80	.52½	6.30	Cherry Bounce, 8 yr old	4.00	1.07½	12.90
" 1 " " " " "	1.60	.47½	5.70	Rock and Rye.....	2.00	.87½	6.90
Bourbon, 10 yr's old	4.70	1.25	15.00	" "extra fine	3.00	.82½	9.90
" 6 " " " " "	3.00	.82½	9.00	Peach and Honey.....	2.00	.57½	6.90
" 4 " " " " "	2.50	.70	8.40	" "extra fine	3.50	.58	11.40

No extra cost for vessels or anything else. Read carefully—Instructions in ordering.

Terms strictly cash with order or one dollar in part payment must be enclosed as evidence of good faith for payment of balance on a C. O. D. shipment; though if good reference is furnished we ship you goods direct. If you remit full amount with order we will allow two per cent. discount from above prices. Remit by New York exchange, post-office or express money order, or enclose currency or stamps in a registered letter. If you prefer, make your money orders or checks payable to or address registered letters to N. G. Williams, who is our president. Our goods are so securely packed that they will ship hundreds of miles without breaking. Shall we ship by express or freight, and to what place? With the very cheap through freight rates from our point your goods will not cost much. Mail us a list giving name and post-office of every person that uses whiskey in any shape and we will mail each one a price list in plain envelope without intimating where we got their names. Send in big orders. Costs no more to register one hundred dollars than ten dollars. Freight and express are cheaper on large lots.

Yours truly, **THE OLD NICK WILLIAMS CO.**  
Or address Lock Box, No. 11, Williams, N. C.

Reference—Every bank in North Carolina, your bank or banker, R. G. Dux & Co., State officers at Raleigh, N. C., our postmaster and express agent, North Carolina Senators and Congressmen at Washington, D. C.

Advertisement for the Old Nick Williams Company Distillery, Williams, North Carolina, circa 1910 (UNC Libraries).



Post Card From  
Southern Pines,  
North Carolina  
Showing a  
Moonshiner  
Tending a Still,  
circa 1910 (UNC  
Libraries).



Illegal production of corn whiskey—moonshining—began as early as the eighteenth century. Also introduced by Scotch and Irish immigrants, the widespread practice of producing whiskey in secret grew out of efforts by the government to collect taxes on it. Violations were minor in scale until after the Civil War when substantial tax increases went into effect (Miller 1989; Becher 2000). Moonshining also received support from the temperance movement, which portrayed alcohol consumption and distilling negatively, thus pushing liquor production into hiding. State prohibition laws around the turn of the twentieth century further expanded the market for illegal alcohol (Miller 1989:216). Moonshining flourished and persisted in the south for the same reasons as commercial distilling: it brought higher prices than unprocessed corn, it was easy to sell, it yielded a reliable source of income, and it traveled more easily than corn (Foy 1989:696-697).

Distilling involved separating a solution of ethanol from fermented plant grains. Commercial whiskeys consisted mainly of corn mixed with varying quantities of other grains. There were many varieties but the industry standardized different blends by the turn of the twentieth century.

Prior to distilling, the grains were processed in a gristmill and then made into fermented matter (the “mash”). As noted, mills were sometimes attached to the distillery to provide a constant supply of grain (Becher 2000). Distillers preferred a coarse grind (Boucherie 1819), which was infused with warm water into a mixture known as “wort.” Yeast was added to this and the wort was allowed to ferment for several days in large wooden vats or barrels (Becher 2000). Boucherie (1819) accomplished this process by adding

the water and grain to a large, rectangular copper kettle that measured around 20 cubic feet and held 100 gallons of water along with four bushels of grain. A brick furnace below the kettle heated the mixture. After skimming the grain from the water and concentrating the liquid with extended boiling, the water was drawn off into barrels and yeast was added. The barrels were then placed in the fermentation room, which was kept at a temperature high enough to activate the yeast.



Views of a Small Distillery. The distilling process is illustrated at right: one man tends a mash tub (right) while a second man works at the furnace heating the still bowl. The steam was condensed in the large tanks to the left and the resulting spirits were collected from the tap, lower left (Rorabaugh 1979).

To distill the alcoholic spirits the “mash” went into a closed container (the “still bowl”) that was heated enough to produce alcoholic steam. The steam exited through a pipe or coil (the “worm”). As the steam passed through the coil, contact with air or cold water converted it to liquid, which then flowed into another container (the “condenser”). Every sequence of vaporizing and condensing was called a “batch,” and a series of batches was a “run” (Rorabaugh 1979:69).

The distilling process underwent several technological changes in the nineteenth century. The earliest apparatus used the simple pot still, in which the heat was applied directly to the container holding the mash. This simple equipment produced single batches.

Introduced in the first quarter of the nineteenth century, patent or continuous stills comprised an improvement over the traditional

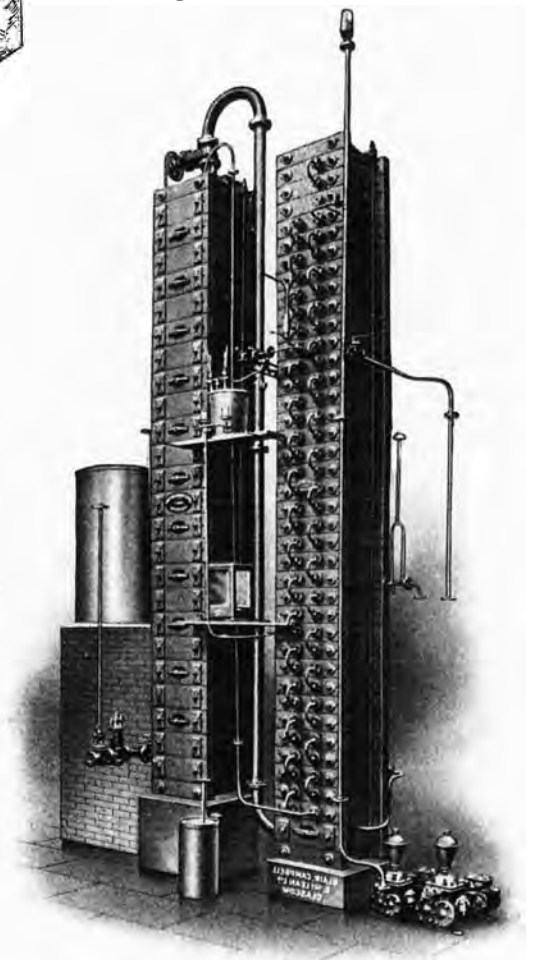

Continuous Still (Martin 1913).







to redistill the alcohol using the heat of the vapor passing through from the still, which eliminated the need to perform a second distillation. It also increased the alcohol content of the final product by drawing from the mash inside it. Finally, it caught any solids or impurities boiling over from the mash (Smith and Des Jean 2007).

The distinctive feature of moonshine stills was their illicit nature, which required that the operation be hidden. Moonshiners often took advantage of rugged terrain to provide seclusion, working in natural low areas or hollows. Areas with thick undergrowth provided further seclusion while forest canopies helped diffuse smoke (Smith and Des Jean 2007). More elaborate measures to hide an illegal distilling operation included one from North Carolina where the still was in a cellar accessible only via trap door. The water supply for the still came through a "secret conduit" from the well in the yard, while an underground drain to a nearby ravine carried off wastewater (*New York Times* 1879).

Small Moonshine Still.  
Georgia, circa 1890  
(Burrison 1983).



A

B

### ILLICIT ALCOHOL DISTILLING.

A. Two Men Operating a  
Moonshine Still. The dense  
vegetation indicates the still  
was hidden in the forest.  
Rabun County, Georgia, early  
1900s (Georgia Archives).

B. Captured and Destroyed  
Moonshine Still. The  
condition of this equipment  
testified to the illegal nature  
of moonshining. Richmond  
County, North Carolina, 1909  
(UNC Libraries).



Distilleries, legal or illicit, had certain needs that affected their location and relationship to other activities and landscape features. The three principal requirements were access to markets, consistent sources of grain and wood, and reliable sources of clean water (Breen and White 2006:214). Water could be the most challenging issue to deal with because in addition to needing it to prepare and boil the mash, water had to be run through the cooling tub and then drained away from the distillery.

Two archaeological studies of distilleries were found for this project. The Harbine Distillery was a rural producer located in Greene County, Ohio. The archaeological site consisted mainly of building foundations, although extensive historical research suggested how these buildings operated and related to one another. Features representing the stillhouse included a set of brick footers, a limestone pavement, and a massive brick hearth and chimney. The distilling equipment had been removed from the site. The building was interpreted as probably having open sides and a shed or suspended gable roof. A second structure adjacent to the stillhouse was interpreted as a malthouse or work area for packing finished whiskey. A third structure represented by massive limestone footers was intended to support considerable weight, suggesting it might comprise a bond house (for storing the whiskey during aging) or mashing and fermenting area (Becher 2000).

A study of a large and elaborate plantation distillery focused on the Mt. Vernon whiskey distillery built by George Washington in the 1790s. Washington's operation was relatively large, consisting of five stills located inside a specially built 75x30-foot stone structure. Archaeological remains of this distillery included a stone floor and brick furnace base, probably representing the mashing and fermenting room. Brick hearths associated with heat-altered soil reflected the still locations. A series of drains beginning adjacent to the furnaces were for taking water away from the condensing tubs (Breen and White 2006). These two sites indicated that the general layout and operation of a distillery could be discerned from archaeological data, although the interpretations also required comparisons to archival sources.

Archaeological investigations of moonshine stills have focused on their distributions and technology. A recent study based on data from Big South Fork National River and Recreation Area (NRRA) in eastern Tennessee and Kentucky provided a good overview of how still sites relate to certain physical and cultural influences. Based on over 175 still sites in the NRRA, Smith and Des Jean (2007) found that they exhibited very little variability and were consistent in terms of location, internal features and organization, and artifact content. Stills in this study area almost always contained obvious remnants of a furnace, consisting of a semi-circular or U-shaped stone hearth that was mortared with mud and contained interior metal stands for the still pot. The sites also usually contained a pair of stacked sandstone platforms arranged in a line



Archaeological Remnants of an Early Twentieth-Century Still Site (9BK417), Burke County, Georgia (Adams et al. 2006).

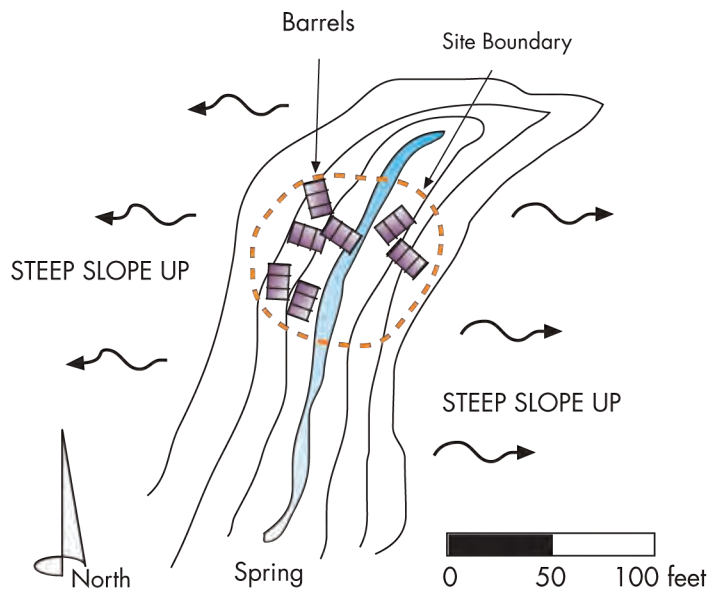

that extended away from the firebox. These were bases for the thump keg and still condenser.

In addition, Smith and Des Jean (2007) found that still sites were regularly located near a creek, waterfall from a rock overhang, or had an excavated water storage feature. Sometimes metal pipes were present that carried the water from the source to the manufacturing area. Artifacts were generally sparse at still sites, possibly because the moonshiners took them





away and hid them to avoid confiscation by revenue agents. Smith and Des Jean often found mason jars, barrels, washtubs, and other items scattered in isolated locations, which they took to be hidden moonshining equipment. Also, moonshine stills used materials with high value, such as copper, that was apt to be salvaged. They note, however, that the artifacts commonly found at moonshine sites include mostly wooden and metal containers, used for manufacturing, as well as those used for collecting and transporting the final product such as jars, jugs, metal cans, medicine bottles, and even gallon-sized bleach bottles.

Still sites in the Sand Hills are likely to share certain characteristics with those identified in the Big South Fork NRRRA. An early twentieth-century example identified in Burke County, Georgia (9BK417) did not possess any structural remains, but included a scatter of 55-gallon metal barrels located at a springhead. The topographic setting consisted of a narrow ravine with steep sides (Adams et al. 2006).

Although both legal and illegal liquor distilling took place in the Sand Hills, sites related to moonshine production are probably more numerous, given the prevalence of this activity and because it was comparatively easy and inexpensive to set-up and operate. Archaeological components of moonshining are expected to include sites located at or near water sources, evidence of a furnace to heat the boiler, and remnants of the still and associated copper tubing. Evidence of the containers used to hold and decant the liquor and other liquids would also be expected and might include barrel hoops, buckets, ceramic jugs, and glass containers. Sites dating to the twentieth century, particularly after 1920, might also contain steel drums used for containers (Adams et al. 2001:410; Botwick and Adams 2003:19).

## DISTRIBUTIONS AND RESEARCH

Several liquor still sites have been identified at the DOD installations included in this study. No commercial distilleries are known and the sites all represent moonshine stills. Fort Jackson contains one recorded still site (38RD902). This site contained a scatter of Mason jars and lid liners along with a possible chimney foundation. The site occupied a knoll crest and was about 130 feet from the nearest water source (Steen and Braley 1992:258). Although the jars are consistent with a still, the location on a topographic high spot and distance to water make the identification of this site unclear. One still site (9HT51) was also identified at Robins AFB. This site was not investigated in detail but was described as being on a basically featureless area of the river floodplain (Blanton and Reed 1987:107).

Two possible still sites have been identified at Fort Gordon. Site file data indicated that both sites occupied locations that are more plausible for stills. Site 9RI709 lay at the base of a ridge spur that was bounded by wetlands on three sides, with the fourth side sloping up steeply and providing some shelter and seclusion. Likewise, Site 9RI761 was on slope-side bench adjacent to a spring. Artifacts associated with the sites included brick scatters, possibly being remnants of fireboxes, metal drums, and other containers.

Fort Benning contains seven sites identified as moonshine stills. Site files provide varying amounts of information about these sites. Those with the most detail (9CE1457, 9CE1843, 9ME525, 9ME539, 9ME789, and 9ME890) appear to reflect clear examples of illicit liquor making. These sites typically occupied terraces of small streams or creeks and contained assorted artifacts associated with stills, including bricks; metal, glass, and stoneware containers; and metal pipes. One site (9CE1457) also contained barrel hoops, which was an unusual find for these sites, as most appeared to have operated with metal equipment. Another unusual component was found at 9ME789, where excavated vats were lined with riveted tin sheets.

No analysis of still site locations at Fort Benning has been conducted to date. As seen in the site files, the sites exhibit typical characteristics of stills, including the proximity to water. Presumably these sites were also located in covert locations, although the variables that would indicate this were not always clear from the site files. Another point to consider is that while water access was a prerequisite for locating a still, they were never near roads. Moreover, moonshiners always took care not to leave signs of trails leading to the still (Smith and Des Jean 2007).

Smith and Des Jean (2007) indicated other variables that might affect still locations and that might be worth examining at Sand Hills still sites. One of these is market access. Although moonshining was often characterized as a farm-related activity, at the Big South Fork NRRRA Smith and Des Jean found the highest densities of sites were associated with coal mining towns and logging camps, where ready markets for moonshine existed. Moreover, oral histories indicated that moonshiners often purchased the raw materials and so were not necessarily farmers. For Sand Hills sites, it would be necessary to look not only at the distributions of stills but also at the adjacent region to determine where potential markets are.

A further pattern that Smith and Des Jean noted at still sites was the use of similar technology at most sites. For example, fireboxes were almost always built the same way using the same materials. Additionally, the technology was an older and more primitive type than was available for the early twentieth century, when most of these sites were used, suggesting a cultural preference for traditional methods and materials. In examining Sand Hills moonshining sites, similar patterns can be sought.

Smith and Des Jean (2007) proposed topics for further study of still sites that can be addressed with archival sources to provide a fuller context for these resources. These questions include: who was involved with moonshining? Was it mainly farmers or did loggers or people involved in other activities operate stills? Was moonshining a seasonal undertaking or did it take place all year? How much income did moonshiners make? Finally, what role did women have in illicit distilling and was moonshine added to the range of rural products that women traditionally handled, such as eggs and farm products?

## **“THE ALL-IMPORTANT CLAYS OF THE FALL LINE BELT”: MINERAL INDUSTRIES OF THE SAND HILLS**

Although mining and mineral extraction in the southeast are most often associated with coal deposits of the Ridge and Valley regions, numerous other mineral resources had economic significance. In the Sand Hills region, the most important of these included kaolin, bauxite, and fullers earth. Other products such as common clay, sand, and gravel are found throughout the Coastal Plain and Sand Hills but do not appear to have developed into important commercial enterprises as early as kaolin except where they were mined in association with other industries, such as brickmaking. Kaolin, however, emerged as an important commodity in its own right, initially being an important ingredient for making refined ceramics, electrical and sanitary porcelain, special types of bricks, paper and wallpaper filling, pigments, and other products (Veatch 1909:239-240; Kogel et al. 2002:1; Schroeder 2003). Kaolin is a white, clay mineral. Bauxite comprises a constituent of aluminum. It occurs as a noncrystalline clay-like substance that is white to deep brown, depending on its constituents. Fullers earth is a highly absorbent non-plastic clay or clay-like mineral that has applications in various industrial operations. It can range in color from brown and green to yellow and white. Initially it was used to remove grease from wool. By the early twentieth century, however, its major use was in petroleum refining. Secondary uses were for bleaching animal and vegetable oils and fats, manufacturing pigments, for detecting food coloring, and counteracting alkaloid poisons (Shearer 1917:312).

Extensive kaolin deposits occur in the Sand Hills of Georgia and South Carolina, but are less extensive in the North Carolina part of the region. The main producing districts lie along the Fall Line from Twiggs County, Georgia northwest to Lexington County, South Carolina, and southwest between Macon and Andersonville, Georgia (Patterson and Murray 1990:142). Bauxite and fullers earth have roughly the same distributions and were sometimes mined by the same or associated companies (Shearer 1917).

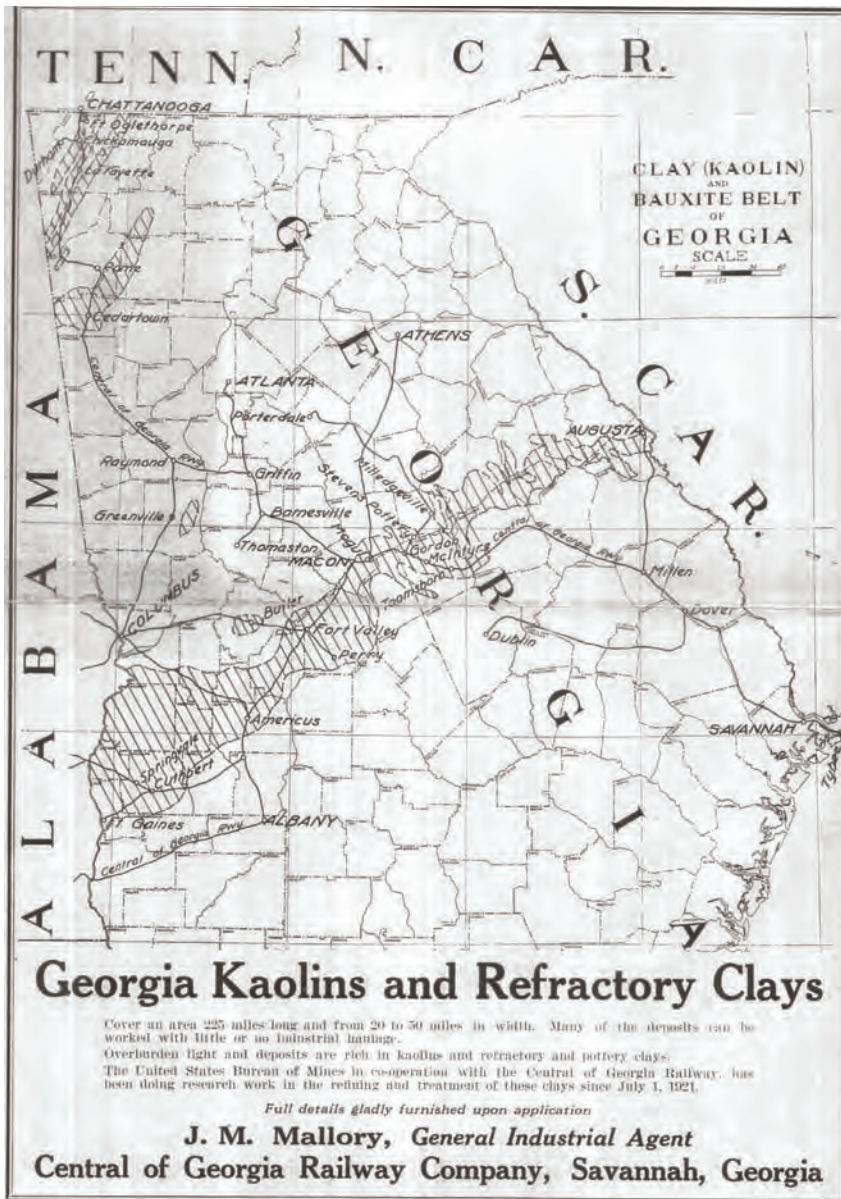

Promotional Map Showing Kaolin and Bauxite Deposits in Georgia (Central of Georgia Railroad n.d.).

Clay mining took place in the Coastal Plain as early as the eighteenth century, although these first efforts, which produced raw materials for England's pottery industry, were more experimental and did not result in substantial exports. The discovery of kaolin in England put an end to American exports until the 1870s. In the meantime, the discovery of kaolin near Edgefield, South Carolina by American potter Abner Landrum

in 1809 influenced the foundation of the Edgefield pottery district. Modern Sand Hills clay extraction industries began with the Riverside Mills of Augusta, which mined sedimentary kaolins in Richmond County starting in 1876. Commercial clay mining has persisted in Georgia to the present, Sumter and Macon counties being among the largest kaolin producers in the world. In South Carolina, Aiken County became an important kaolin producer after the Civil War, while in North Carolina most kaolin was mined from residual deposits in the western part of the state (Patterson and Murray 1990:139; Kogel et al. 2002:1-2).

Unlike common clays used for bricks or pottery, the kaolin, bauxite, and fullers earth were not mined and processed in association with the production of another product. Rather, the refined raw material comprised the end product, which was then shipped elsewhere for use in manufacturing. For the following





Machine-Excavation of Kaolin Mine Overburden. In the mine below, workers excavate by hand. Vicinity of McIntyre, Georgia, circa 1920s (Stull 1924).

discussion, only the processes of making the marketable product are discussed. Mining kaolin, bauxite, and fullers earth followed roughly similar procedures.

## KAOLIN

Descriptions of mines operating during the early part of the twentieth century indicate general practices for extracting kaolin in the Carolinas and Georgia. In the Sand Hills, kaolin was mined in open cuts or surface mines, with water being removed via gravity drains or steam-powered pumps (Sproat 1916:8). Open pits were considered the most practical method because the overlying strata of unconsolidated sand prevented the building of shafts or using other underground methods (Veatch 1909:190-191). The first task in starting a mine was to remove the overburden across an area of 300 to 400 square feet. Kaolin could be extracted economically from below overburden up to 40 feet deep, although the overburden could be as thick as 100 feet in some places. Excavated by hand, steam shovel, or drag scraper, the overburden was considered waste and was hauled to a dump in tramcars (Sloan 1904, 1908:367; Veatch 1909:191; Sproat 1916; Ries et al. 1922:163-164). An important consideration in removing the overburden was the potential for staining the kaolin. The overburden had to be pulled back far enough from the exposed clay face so that if the cut face of the overburden slumped it would not contaminate the clay underneath (Sproat 1916:11).





Mining Operation at the Albion Kaolin Company Site Near Hephzibah, Georgia. The men atop the vertical cut appear to be preparing to pry off a fresh face. Unknown Date (Burgess 1985).

KAOLIN MINE  
OPERATIONS



A

A. Excavated blocks of kaolin were hauled away on cars pushed by hand. Aiken area, South Carolina, circa 1910 (Sloan 1908).



B

B. Hand Excavation of Kaolin. Aiken Area, South Carolina, circa 1900 (Sloan 1904).

Once exposed, clay excavation proceeded by hand or machine, breaking it into lumps that could be loaded into cars for removal from the mine. The method for hand excavation involved excavating downward into the clay to create a vertical face or “breast” from which the pit would expand outward. The clay was too solid to be shoveled and so it was pried loose from the edge of the face using picks or by driving stakes into the top of the clay bed. Steam shovels were also used, although they do not appear to have been the rule during the first part of the 1900s. Maintenance or “housekeeping” was necessary during the operation of the mine, particularly to keep water out of the pits. Pumps and drainage ditches were used in the bottom of the pit, while shallow ditches were also installed at the top of the cut face to intercept water seeping from the remaining overburden (Sloan 1904:63, 1908:367; Veatch 1909:191; Sproat 1916:12).

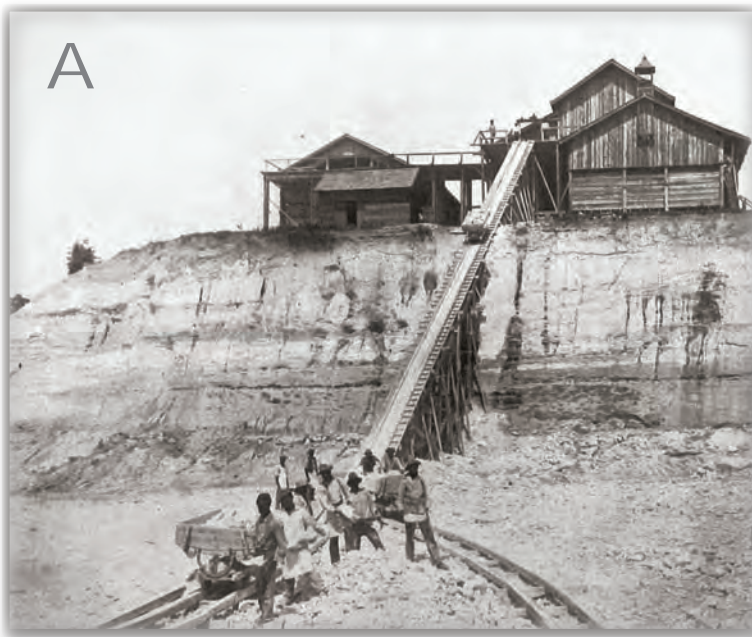

As the clay was removed from the face, it was broken into chunks about one cubic foot and sorted into grades based on color. The chunks were loaded by hand into wagons or carts and hauled out of the pit to the air-drying shed, located outside of the pit. Commonly, clay was brought to the drying shed on a ramp or inclined track from the bottom of the pit to the upper story of the drying shed. The cars were pulled up with a cable and winding drum, overhead tramlines, or other means (Sloan 1904:63; Veatch 1909:191; Sproat 1916:12-13).



#### TRANSPORTATION IN THE KAOLIN MINES

A. Clay-filled cars were hauled out of the mine pit to the upper story of the drying shed. Aiken area, South Carolina, circa 1900 (Sloan 1904).

B. Overhead tram line used to remove clay from the mine. Dry Branch District, Twiggs County, Georgia, circa 1915 (Sproat 1916).





#### KAOLIN PROCESSING

A. Small Kaolin Drying Shed, Jones County, Georgia, 1890s (Ladd 1898).

B. Detail of an Air-Drying Shed for Crude Kaolin. Georgia, circa 1915 (Sproat 1916).

Drying was the next stage in processing. Drying sheds consisted of long structures with open sides that allowed air to circulate. The clay was placed on racks measuring about 15 feet wide (approximately the length of the building) and four feet deep, which were stacked three to six high. The racks possessed removable slat bottoms. As the clay in the lowest rack dried, the slats were moved apart to dump the clay onto the floor below and the clay from each rack above it dropped to the next lowest rack. The dried chunks on the floor were broken up with mauls or in mechanical roll crushers to sizes that could be packed into casks for shipping (Mine 7)(Sloan 1904:63; Veatch 1909:192; Sproat 1916:12-13). For most kaolin producers, shipping was the end of the production process until at least the first decades of the twentieth century.



Some companies, however, refined the kaolin through a process of washing. Sproat (1916:13) described the process as practiced at the Georgia Kaolin Company plant near Dry Branch in Twiggs County. The process involved first blunging the clay (mixing it with water to form a liquid suspension) in tanks measuring 10x4x4 feet. The resulting slip was let into troughs about 50 feet long and two feet wide to let the impurities in the clay settle out. The slip was then screened as it was piped into concrete tanks, about 75x25x5 feet, where it stood for a few days to concentrate. The floating liquid was then drawn off and the concentrated slip was put into a small retaining tank. Filter pressing the slip produced cakes containing about 25 percent water, and these went into tunnel driers or open air sheds for thorough drying. The dried cakes were then crushed to small pieces in corrugated rolls. Modern refining methods vary depending on the intended application of the kaolin. Improvements to the process described here included chemical treatments, physical delaminating, and high temperature heating, which improve the chemical bonding properties of the kaolin when mixed with other components and/or to improve its brightness in kaolin-based products (Schroeder 2003).

Casks Filled with Dried Kaolin and Shipped by Small-Gauge Railroad. Aiken area, South Carolina, circa 1900 (Sloan 1904).



Several conditions affected the location and operation of kaolin mines. The general homogeneity of clay beds across horizontal areas meant that the principal factors influencing mine location was proximity to transportation and depth of overburden. Mines were typically located along main railroad lines or connected to them with short spurs. Mining companies also built narrow-gauge roads to connect to the main lines, while a few opted for wagons and the local roads (Ries et al. 1922:192).

Thickness of overburden also influenced location because the deeper it was, the more expense was required to remove it. Through the 1920s, if the overburden exceeded about 3.5 times the thickness of the underlying kaolin deposit, then the cost of removing the overburden would not pay off. Because streams cutting down through the Sand Hills terrain often exposed commercial clays, these were the easiest to discover and overburden was usually shallowest at the stream valleys. Therefore, mines often occupied positions at stream edges and extended away from the valley until the overburden became too deep to remove economically. If it did not become too deep, sometimes the entire area between valleys could be mined (Ries et al. 1922:192-193).

Modern kaolin mining and processing is more extensive and elaborate than that conducted in the early twentieth century, although the essential steps are similar. Technological advances allow deeper mines as well as more flexible transportation. Because kaolin varies in quality in different locations, companies operate more than one mine, taking the excavated material to a central stockpile where separate clays are blended. Processing can vary from company to company and there are many different methods available (China Clay Producers Association 2007).

## BAUXITE

Bauxite, as noted, occurs in the same general regions as kaolin, and in some instances overlies it. Mining techniques resembled those for kaolin, although were simpler in some respects. Shearer (1917) described the process as it was performed during the first part of the twentieth century. At that time, hand excavation comprised the sole method for removing overburden and the ore itself, although nearby kaolin and fullers earth operations used mechanical equipment. Ore deposits reached maximum thicknesses of 10 feet but sometimes could be below 40 feet of overburden. The excavated overburden and ore was hauled out of the mine by hand or mule power. Bauxite occurs near the surface and was

Bauxite Lens Exposed at the top of a Kaolin Mine, Georgia, circa 1920s (Stull 1920).



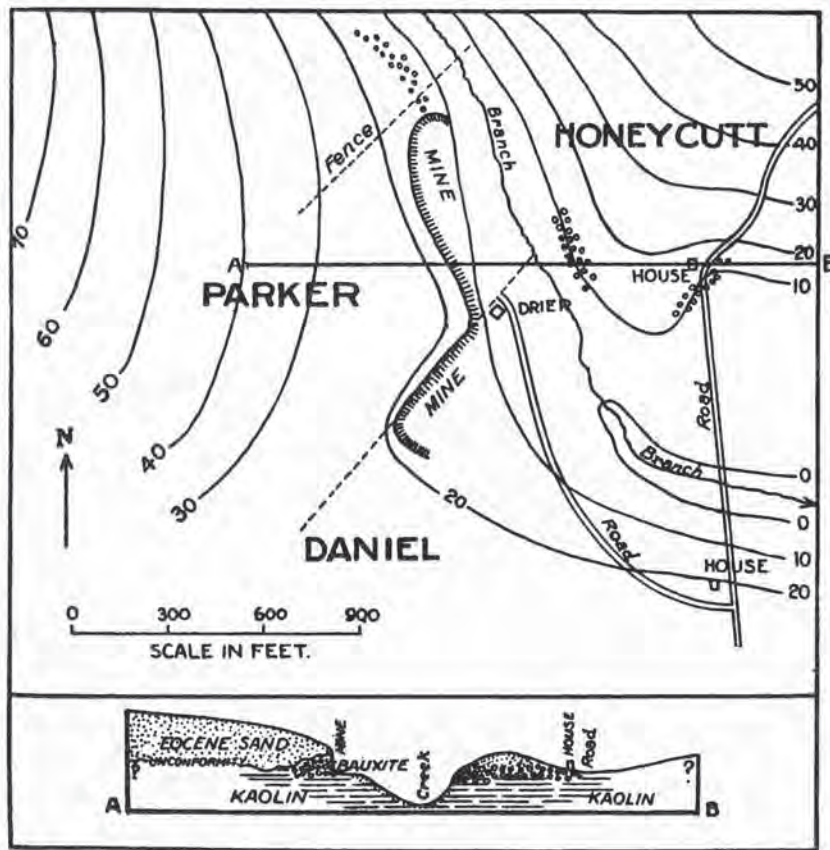

A

#### BAUXITE MINES: LAYOUT AND LOCATION

A. Sketch Map of the Republic Mining and Manufacturing Company Operation, Wilkinson County, Georgia, Showing Mine Areas Located Uphill from the Drying Plant. Around 1915 (Shearer 1917).

B. Elevated Track for Moving Bauxite to the Drier. Republic Mining and Manufacturing Company, Wilkinson County, circa 1915 (Shearer 1917).

B



typically collected in strip mines at higher elevations than the processing plant. Thus, whereas kaolin had to be hauled upward from the mine to the plant, bauxite took a relatively level or downward route.

Bauxite deposits formed sharp interfaces with the overburden, making it easy to distinguish once it was exposed, but it tended to grade into the next stratum, often composed of kaolin. At the time Shearer wrote, the only way to determine if the bauxite deposits were becoming too diluted by kaolin was to check the quality of the prior shipments after they were processed (Shearer 1917:133).

Preparation for shipment entailed only drying and sometimes screening. The objective of this process was to eliminate water weight, which increased freight charges. Smaller operations typically air-dried the ore in sheds or on board floors in open yards. Larger mines might use rotary cylinder kilns measuring about 30 feet long and four feet in diameter. Wood fires provided the heat and gradually dried the ore as it passed downward through the slightly tilted kilns. The dried ore was then mechanically lifted into bins for loading on to wagons or trucks (Shearer 1917:133).

As with kaolin mines, access to transportation was important. Shearer (1917:134) characterized the bauxite districts as well-supplied with railroads, although it is not clear if the railroads followed the mines or if mining became feasible because of preexisting railroad connections. Companies hauled the ore to railroad stations in wagons.

## FULLERS EARTH

Fullers earth mining followed similar procedures as kaolin and bauxite extraction. Shearer (1917) described the process as followed in Georgia during the early twentieth century. All mining was done in open cuts or pits, first removing the overburden by steam shovel or steam drags, at least at larger mines. Smaller operators probably removed the overburden with pick and shovel. Steam equipment might also be used to excavate the fullers earth, although Shearer indicated hand excavation was more common. Steam locomotives or gravity-driven trams carried the mined earth to the drying and grinding plants. Gravity-operated trams were arranged so that a descending loaded car pulled an empty car up to the level of the mine, located in a low area relative to the ridge-top mineral deposits (Shearer 1917:181, 311; also Sellards 1914:30).

Preparation for market involved drying and grinding. Drying procedures for fullers earth depended on its intended use. If meant for bleaching vegetable oils, it was dried at lower temperatures so that it retained the integral water. Material intended for use on mineral oils was dried at higher temperatures but never high enough to fuse any of the inherent minerals (Shearer 1917:311). Sloan (1908:341) described a two-part drying process in which the mined fullers earth was air dried a few days, then crushed to pass through a three-quarter inch screen, and then passed through a rotary drier heated by an oil furnace. More typically the freshly mined earth was sent to a crusher to be broken up, which eased handling and drying, and then put through the drying process. In addition to rotary kilns, the fullers earth might be molded into bricks for stacking on cars and put through a tunnel drier (Sellards 1914:30-31; Shearer 1917:181-182).



The dried fullers earth was processed through grinders to reduce it to the desired fineness. Roller mills were used if the goal was to produce a single degree of texture. If different grades were required, more versatile mills were used. Bolting machines like those used for grading flour were employed to sort the ground material. Bolters or air separators divided the material into storage bins and from these it was weighed and bagged for storage (Shearer 1917:312).

## COMPONENTS OF SAND HILLS MINING OPERATIONS

Primary and secondary sources utilized for this study described the processes involved in clay and mineral extraction and preparation for shipment. These studies did not, however, provide specific information on the requirements or components of typical kaolin, bauxite, or fullers earth operations in the Sand Hills or adjacent regions. This information can be sketched out with reference to illustrations in contemporary sources and modern archaeological references.

The basic components of all three operations described here included extracting the raw material, moving it from place to place, drying, grinding, and shipping. Extraction took place in surface mines in the Sand Hills and remnants of these features would consist of large open pits or cuts into ridge slopes or valley walls. Although hand excavation was the most common technique, some operations used mechanical equipment to remove overburden and sometimes the target product as well. They typically used trams to move the material out of the mine and remnants of trackways or other conveyors might be found archaeologically. Finally, spoil deposits representing overburden might be found near the mine or in a convenient dumping spot, such as a stream valley.

Drying, crushing, and other processing took place in structures outside the pit. Contemporary sources describe these structures as "drying sheds," and photographs indicate considerable range in size and construction (Ladd 1898; Sloan 1904, 1908; Veatch 1909; Sproat 1916; Shearer 1917). The simplest structures consisted of open-sided sheds (Ladd 1898) while the most elaborate, represented by a kaolin refining plant near Dry Branch,



A Kaolin Plant for Refining Crude Clay. The Georgia Kaolin Company Plant, Twiggs County, Georgia, circa 1915 (Shearer 1916).

Georgia, encompassed several drying sheds in two forms: large open-sided structures for crude clay and low, open sided structures for washed clay. This plant also included settling basins, and a collection of large enclosed buildings that presumably housed driers, crushers, storage, and packing areas (Sproat 1916). Although developments over time probably caused some of the differences between these two examples, Sloan's early 1900s study indicated that some producers put together building complexes that included very large, multi-storied structures (Sloan 1904, 1908). Although contemporary sources do not discuss it, it is likely that these operations also included areas or separate structures for various activities related to maintenance, storage, administration, and others.

Transportation within the plant and to markets could be accomplished in various ways. As noted, trams and carts pulled by steam engines or cables were commonly used to move the clay out of the pit. Handcarts and conveyors were probably used to move dried and crushed clay within the plant. For shipping, if railroad lines were present, then they were taken advantage of. If the rail line was located at a distance from the plant, a spur could be built to the plant or the product could be taken to a station on carts or trucks. If the plant washed the clay, which seems to have been rare during the early part of the century, a series of flues or troughs for moving slurry would also exist at the plant.

The overall arrangement of the clay, bauxite, or fullers earth operation could vary. As with mining operations documented in the western states, mining operations in the Sand Hills consisted of “feature systems” that could be spread out over a wide geographical area (Hardesty 1988:10). Although some photographs show the processing facilities immediately adjacent to the clay pit, sketch maps of specific operations in Shearer (1917) showed facilities sometimes spread across a broad area. In most instances, though, the mines and drying areas were within a few hundred feet of each other. The mining complexes also included roads and sometimes railroad lines.

## ARCHAEOLOGICAL STUDY OF SAND HILLS MINING

Only one possible mining site has been documented among the DOD installations included in this study. Site 9RI920 at Fort Gordon was interpreted as the site of the Chapman Lignite Mine. Lignite is a carbonaceous material that occurs in association with fuller's earth. Its greatest value was as a component of commercial fertilizer. It does not appear to have been mined to any large extent in the region (Veatch and Stephenson 1911:284, 270; Shearer 1917:248). Site 9RI920 covered a large area (measuring 360x345 feet) on a ridge nose overlooking a stream. Dating to the twentieth century, the site consisted of primarily surface features including a large, sub-grade, cement-lined foundation; several brick lined wells; cement

pylons or structural supports; and a possible chimney foundation. Shovel testing produced few artifacts besides miscellaneous hardware, while test units exposed a possible wall foundation of sandstone and cement. Archaeological investigations at this site did not produce any clear evidence of site function, and the report on these investigations did not state if a mine pit or cut was present anywhere in the vicinity of the site. The interpretation of the site as the lignite mine was based on early twentieth-century reports that placed it in this general vicinity (Grover et al. 1997).

Quite a few archaeological and cultural resources identified as mines have been recorded in Georgia. Site file data for these sites, however, does not provide sufficient detail to reliably determine what the sites included and represented. Many of them were interpreted as prospecting holes, consisting simply of pits excavated into the ground to various depths. Associated features were rarely described, although sometimes railroad beds and other structures were noted. In some instances, the identification as a mine is clearly incorrect, and at least one site identified as a mine reflected a prehistoric stone quarry. The statewide site file data are therefore difficult to utilize to make generalizations and to suggest research topics for historic Sand Hills mining operations.

That said, however, it is apparent from the site files that archaeological resources associated with mining typically consist of the mine, which is represented by only a pit or cut bank. As discussed above, mining operations included complexes of activity areas and features associated with the extraction, processing, and transportation of the raw material and the processed or refined product. Moreover, a single mining operation could include dispersed facilities spread out over a broad area.

Archaeological investigations to pursue at Sand Hills mining sites would involve ascertaining what they consist of beyond the mine itself. For the Sand Hills, this would entail expanding a study area outwards from the extraction site to identify transportation facilities, drying houses, administrative buildings, and other features. Additional tasks would be to document these facilities as fully as possible. This kind of information would be the most useful for determining how these mines operated and understanding their technological and historical contexts.

More broadly, there are various issues that provide research and evaluation contexts for mining sites. In dealing with silver and gold mines in Nevada, Hardesty (1988) presented issues that are applicable to clay and mineral extraction in the Sand Hills such as mining and world systems, the technology of mining, and the archaeology of mining settlements and households.

The issue of mining and world systems is particularly interesting for Sand Hills research. Unlike many of the other industries covered by this study, kaolin, bauxite, and fuller's earth mining in the Sand Hills was undertaken exclusively for markets located outside the region and this industry linked rural and relatively isolated Sand Hills communities to major industrial centers. The issue of mining and world systems encompasses different interaction spheres, including materials, population, and information. The first of these consisted of a network for moving materials between frontier and industrial centers, including supplies necessary to operate the mines and the raw materials used for industry. The population interaction sphere deals with worldwide migration networks that created labor forces for mining. It is unclear how significant this issue is for Sand Hills mines, which seem to have primarily drawn on local workers. The information sphere has to do with the exchange of information, ideas, and symbols. Hardesty (1988:4-5) emphasized the technological innovations, such as in transportation, publishing, and telegraphy, which made communication and transfer of knowledge about mining more efficient and widely available. Additionally, he places mining operations into the context of Victorian ideologies and discusses how these influenced how the work places, company towns, and domestic areas reflected them.

The technology of mining is another important topic to address. While some general information was obtained about how early kaolin, bauxite, and fuller's earth mines were organized, few details were provided by contemporary sources. Archaeology represents an important means of examining how minerals were extracted, how technological processes were applied to this work, and how, when, and where new techniques were introduced.

Issues dealing with mining settlements and households are not well delineated for the Sand Hills. The origins of the labor force are not known at present, but they appear to have been local and provided their own housing. It is unknown if mining camps existed in association with any Sand Hills mining operations. This topic remains open to considerable research, for both archaeologists and historians. Dealing with topics such as these will allow for a much fuller understanding of this important but poorly documented Sand Hills industry.

## “FLUFFY MASSES OF COTTON LINT ADHERING TO SEEDS”: COTTON GINNING

The spread of cotton as one of the South's most important cash crops was intimately related to the rural industry of cotton ginning, the process of removing seeds from cotton bolls. In point of fact, Eli Whitney's



1793 invention of the cotton gin, the machine that removed seeds, enhanced the economic viability of the crop and enabled its spread from the coast to the interior. Prior to this development, the seeds had to be removed by hand or with early varieties of cotton gins that had been developed in India (Britton 1992:10). These methods were so slow and had such low rates of output that it barely paid to grow cotton commercially. Whitney's device, however, made the process much faster and productive and ultimately contributed to the expansion of south's most iconic crop.

The term "cotton gin" or "ginning" came to refer to the group of buildings and machines used to process cotton and prepare it for shipment to textile factories. The device for removing seeds from the boll was called the "gin stand." These terms are used in the following discussion. Cotton ginning refers only to the process of removing seeds from the cotton bolls and preparing the raw cotton for shipping. Turning the cotton into threads for textile manufacture involved a separate set of activities and was not a commercial industry in the rural south.

Cotton gins were common landscape features in the antebellum era, being found on most plantations or farms whose owner possessed the funds to invest in the equipment. These owners provided ginning for their neighbors (Aiken 1989:568-569, 1998:12; Britton 1992). Technological improvements in the 1880s led to larger gins that were more centrally located and served widespread areas, as opposed to the earlier gins that serviced relatively small neighborhoods. These later ginneries also reflected new ownership practices. Where antebellum owners were predominately wealthy planters, the post-war pattern saw merchants come to dominate the ginning industry (Aiken 1973).

The new practices also linked cotton processing to new enterprises and new ways organizing cotton growers. Prior to the war, planters owned all aspects of production, from the planting of the seed through harvest and ginning to packing for shipment. The emergence of mercantile ownership, along with systems of tenancy brought gin owners with some involvement in farming, but also in cotton warehousing and factoring, banking, fertilizer production and distribution, and possibly other activities (Aiken 1998:39-42). The community gin also became important social and landscape fixtures of towns and settlements (Britton 1992:53). Another development in the later nineteenth century was the introduction and spread of the cottonseed oil industry, which developed as a by-product of ginning. Although not numerous compared to gins, cotton oil mills increased in number relatively quickly during the last decades of the century. They were almost always affiliated with and located in close proximity to ginneries or owned by ginneries but dispersed throughout the nearby towns and countryside (Aiken 1998:45-46). The cottonseed industry also provided farmers with a new source of income by selling surplus seed to the oil mills. This could be

extremely important as tenants and small farmers might have little or no saleable cotton after paying off their annual debts to supply stores (Phillips 2004).

The overall trajectory of the cotton ginning industry progressed through several modifications, improvements, and expansions as a result of technological advances. Britton (1992:xiii) identified four main stages, the first being the invention of the cotton gin stand in 1793. The second major advancement, which occurred in the 1880s, was the development of the “ginning system” (Aiken 1989:569), a mechanized procedure that involved pneumatic handling of bulk seed cotton, the introduction of steam power, integrated ginning and baling, and automated movement of the cotton through the plant. The third improvement stage was the introduction of machine harvesting in the 1950s. This stage gave rise to other improvements to the ginning process because the seed cotton it produced tended to contain more moisture and debris than hand-picked cotton. The last stage dates to the 1970s and consisted of the development of modules. Modules are the primary unit of storing seed cotton after it is removed from the field by a harvester but before it is ginned (Wakelyn et al. 2005).

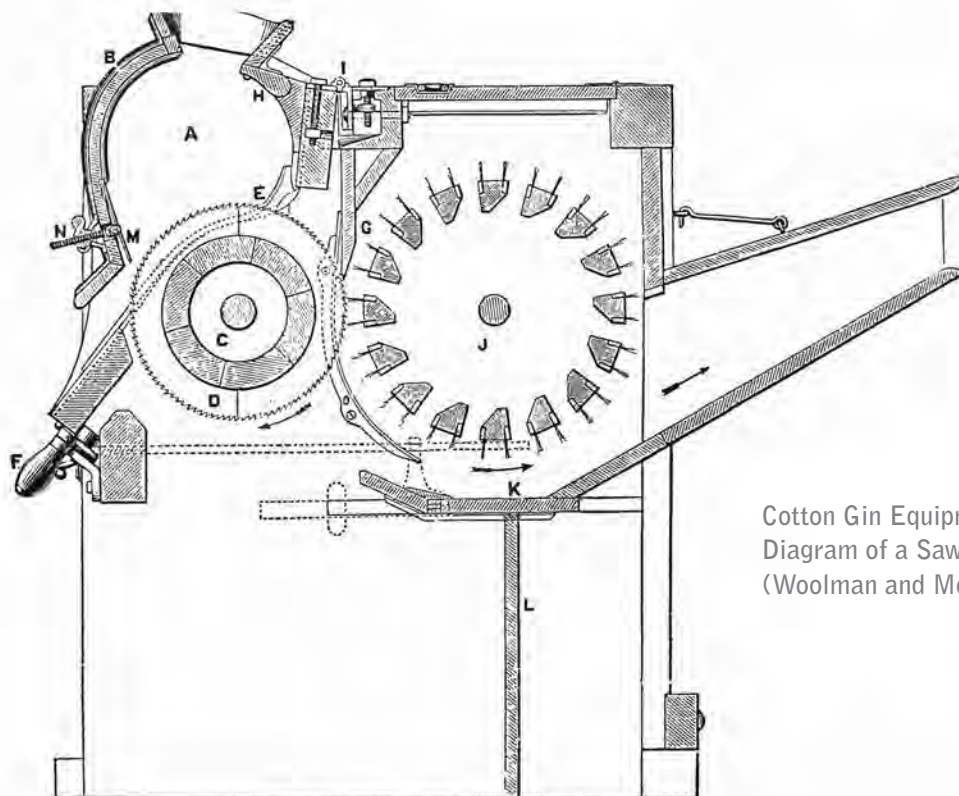

Cotton Gin Equipment.  
Diagram of a Saw Gin  
(Woolman and McGown 1920).

The essential tasks of cotton ginning were to remove the seeds from the bales and pack the raw cotton for shipment to textile mills. The gin stand separated the cotton fibers from the seeds. Early models consisted of rotating wooden cylinders with wire teeth, while later improvements included saw teeth on the rotating drum or circular saws. With both versions, the teeth pulled the cotton fibers through a grate that was too small for the seeds to pass through. A second rotating drum, mounted with brushes, removed the cotton lint from the teeth (Phillips 2004; McVarish 2008:218). In the 1820s factory-made cotton gins became available and by mid century large producers dominated the market, although smaller local manufacturers also existed (Phillips 2004).

A

#### COTTON GIN EQUIPMENT

A. Picker Roll of a Saw  
Gin, Leslie Mill Site, Fort  
Bragg, North Carolina

B. Picker Roll Detail



B







### PLANTATION COTTON GIN

A. The cotton gin is housed in the two-story building while the structure to the right is the baler. Unknown Location and Date (Brooks 1898).

B. A cut-away view of a plantation gin showing the gin stand on the second floor and power train below.



Antebellum cotton gins, which were found on most plantations, typically consisted of a two-story structure with the gin stand on the second floor and the power train housed on the ground floor. The lower story normally did not have walls enclosing it except on the side that abutted the lint room. Mules or oxen supplied the power for the drive gear. The size and capacity of the gin was measured by the number of saws the stand contained, the most common types contained around 60 saws and could process enough cotton each day to make three to six 400-pound bales. The press, located in a separate structure next to the gin house, turned out the bales. Planters bought the gin stand, power train equipment, and press from manufacturers and set up the gin house following carpenter's patterns. In addition to these basic components, gins also required places for storing the seed cotton as it came in from the field and for lint cotton waiting to be baled. Commonly, the gin room on the second floor of the building contained enough space for the seed cotton. Ideally, all functions of the gin were conducted under shelter (Tompkins 1901:32; Aiken 1973, 1998:12-13; Britton 1992:26).



Plantation Cotton Baler, Eastern  
North Carolina. Unknown Date  
(UNC Libraries).

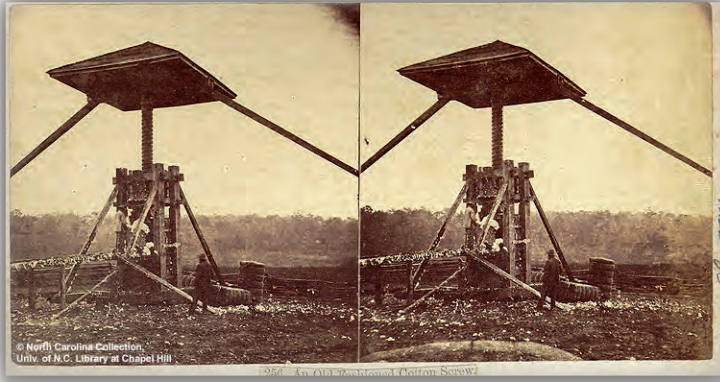

In operation, the open space below the gin floor contained a vertical shaft with a cog attached to it as well as two levers. Draft animals hitched to the levers turned the cog, measuring eight to 10 feet in diameter, and set into motion a horizontal shaft hung from the beams of the upper floor. A belt attached to this shaft powered the gin stand. The seed cotton was fed into the gin stand, which

discharged lint cotton into an upper lint room. Hands threw this material down into a second room at ground level where it was trampled to compress it and save space until taken to the press. The press consisted of a large packing screw mounted in a tall structure. Animals pulled two long levers attached to the top of the screw, and as it pressed downward, a plunger at its lower end compacted the cotton into a wooden box large enough to produce bales weighing 400 to 500 pounds and measuring about five feet long, 30 inches thick, and 40 to 48 inches wide (Tompkins 1901:35).



C



#### COTTON GINNING SYSTEM

A. Typical Structure Associated with the Ginning System. Green County, Georgia, circa 1920 (Aiken 1998).

B. Cut-away View of a Ginnery Showing Its Interior Arrangement (Tompkins 1901).

C. Detail of Seed Cotton Being Unloaded with a Pneumatic Suction Pipe, Brownsville, Texas, 1920 (Library of Congress).

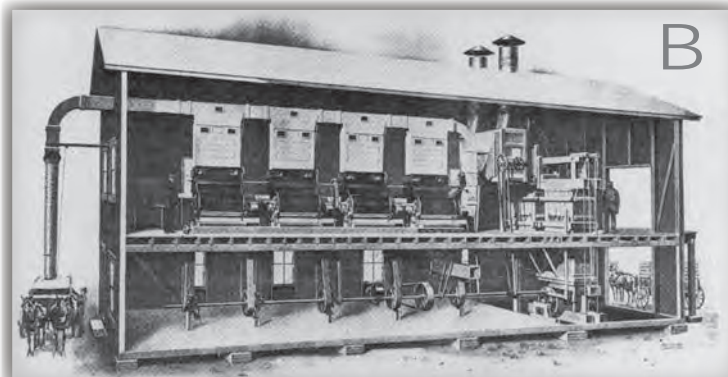

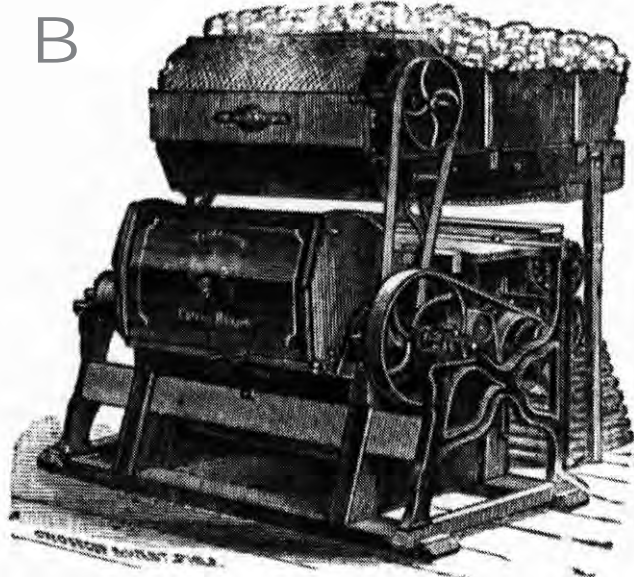
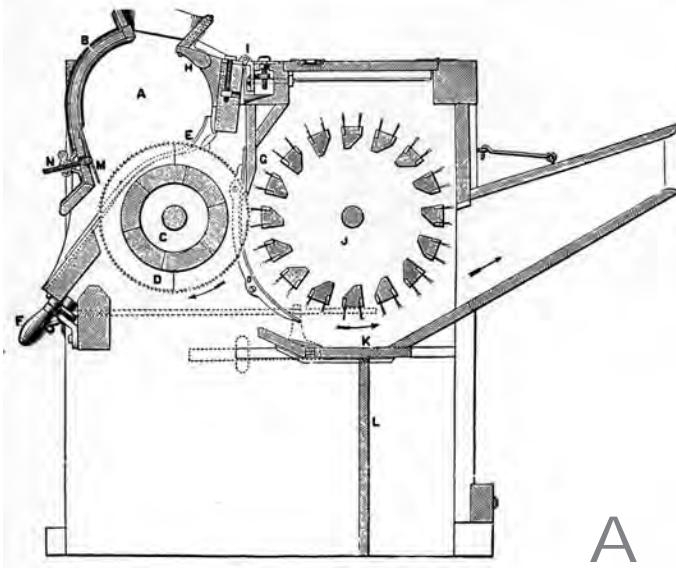

SAW GIN, CIRCA 1900

A. A diagram showing operation of a saw gin as used with the ginning system (Tompkins 1901).

B. A Saw Gin (Tompkins 1901).

Technological developments gave rise to the ginning system in the 1880s. This system was the development of Mississippi-born Robert Munger, who sought to improve the speed and efficiency of the ginning process. He eliminated as much hand labor as possible by using fans to create flowing air that moved cotton through the plant (Britton 1992:59). Typical cotton gins of this time were in two-story buildings that were larger than the earlier versions to house additional equipment. Seed cotton was delivered to the mill and unloaded from wagons with pneumatic suction pipes that deposited the cotton into a cleaning device, the separator. From the separator, cotton dropped onto conveyor belts that moved it to a battery of ginning stands. Typically, ginneries would contain between two and six stands at this time, each with 70 to 80 saws. As brushes removed the cotton lint from the saw teeth, blasts of air moved it to the condenser where it was compressed and baled (Aiken 1998:42-43). Condensers were vertical wooden boxes located behind the gin stands and linked by flues. Later ginneries contained a single large condenser that collected the cotton from all of the stands. Inside the

condenser internal drums made of wire rolled it into bats that in turn were taken to the baler for packing. Balers at this time were steam-powered, drawing from the same engines that ran the other machinery in the plant (Britton 1992:54-55, 59).

Twentieth century developments were related to the mechanization of harvesting. Mechanical harvesters tended to bring in seed cotton with higher moisture content and a greater amount of associated debris. Dealing with these problems required greater investments in the plants as well as new processing equipment that dried the seed cotton before it entered the gin stands and had to remove the larger amounts of trash collected by the mechanical harvesters (Aiken 1998:105-106).

### “THE VALUE OF COTTON SEED WAS LONG UNKNOWN”: COTTONSEED OIL

The cottonseed oil industry developed relatively late but provided a means for deriving profits from surplus cottonseed, which traditionally had been a waste product. Manufacture of cottonseed oil on a large scale began during the 1870s. By the turn of the century, smaller mills, such as those more likely to occur in rural districts and small towns, handled about 20 to 40 tons of seed per day. These areas had limited access to rail transport and relied on seed being delivered from a small local area on carts. Larger mills with ready access to railroads handled 100 to 150 tons per day (Tompkins 1901:228-231).

Diagram of a Cottonseed Oil Mill, Highlighting Essential Functions and Equipment (Lamborn 1904).

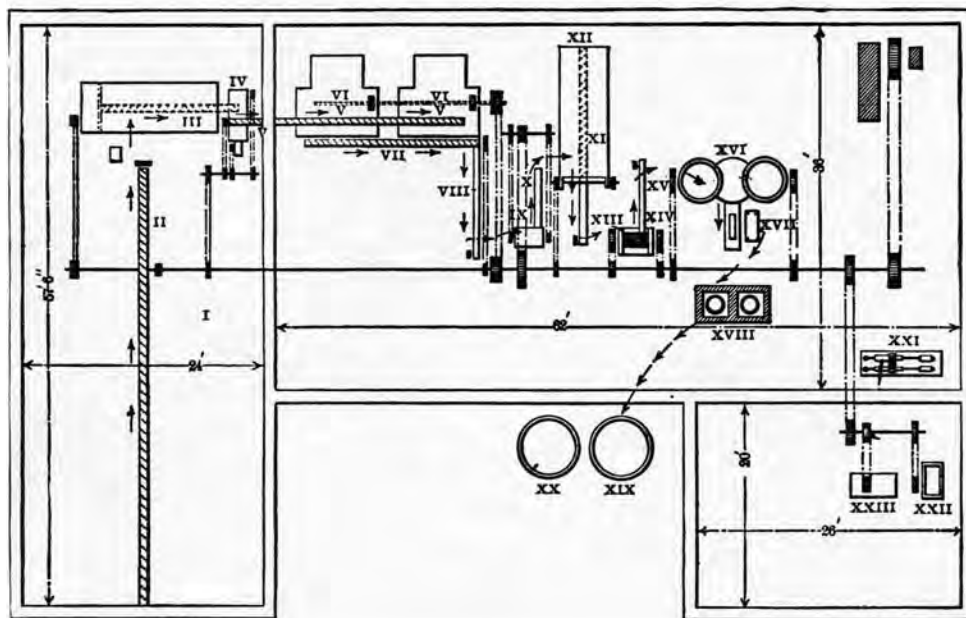



Extraction of the oil was a multi-step process that was carried out in dedicated factories using specialized equipment. The overall process involved: 1) screening and cleaning the seeds; 2) hulling the seeds; 3) separating the hulls and meat or kernels; 4) crushing the meat; 5) cooking the crushed meat; and 6) pressing the cooked meat to extract the oil. Tompkins (1901), the International Library of Technology (1902), and Lamborn (1904) described how cottonseed was processed around the turn of the twentieth century.

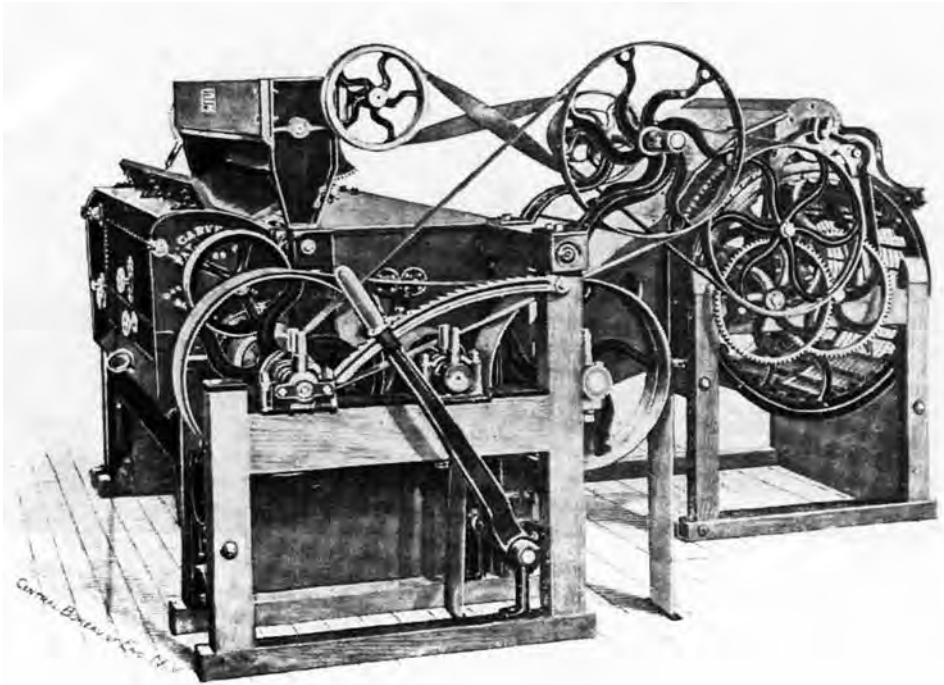

Linter Gin for Removing Residual Cotton Fibers from Seeds (Brooks 1898).

Cleaning the seed involved the elimination of dirt, grit, and other debris, as well as removing traces of cotton lint. The process was accomplished by passing the seeds through a series of screening conveyors, rollers, and buffing equipment. While mainly intended to increase the efficiency of the subsequent processes, the cleaning yielded residual cotton fiber, separated into “linters” and “delinters,” that had value themselves for various purposes such as textile manufacture, cotton wool, papermaking, and wadding for firearms and explosives.

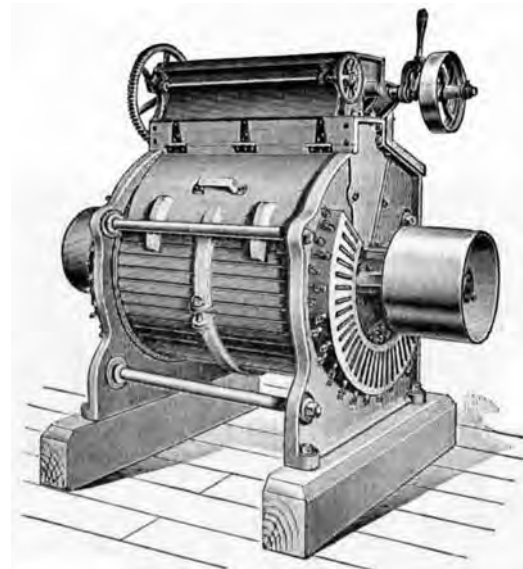

Cottonseed Huller for Removing Kernels from Hulls (Lamborn 1904).



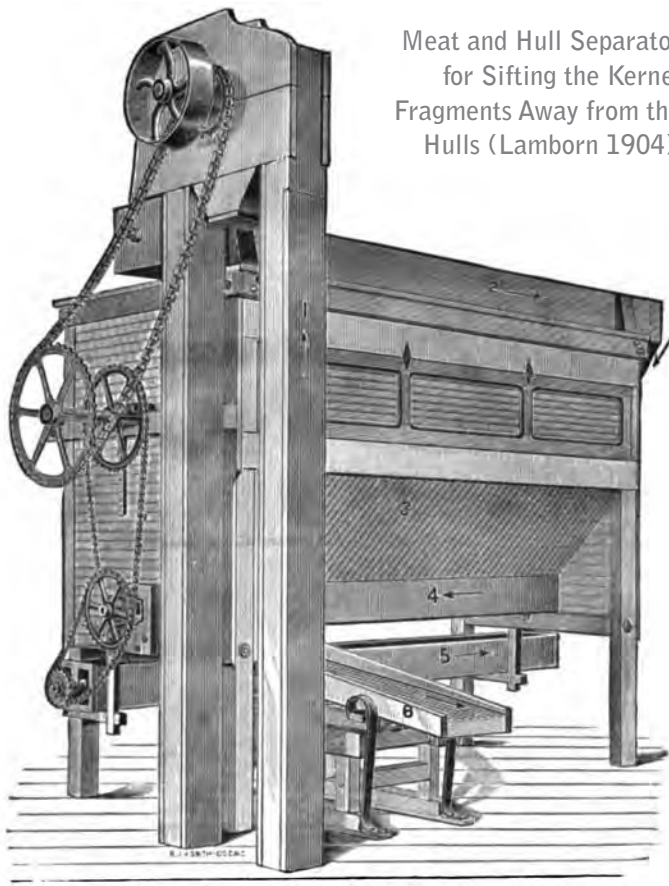

Meat and Hull Separator  
for Sifting the Kernel  
Fragments Away from the  
Hulls (Lamborn 1904).

The next stage of the process, hulling, began the separation of the meat from the seed shells. The seeds were loaded into a huller, consisting of a cylindrical case with horizontal knives on its inside wall. A revolving drum, also equipped with knives, was inside the case. The knives on the drum and on the case wall nearly touched, so that as the drum rotated, the knives cut the tumbling seeds to small pieces. From here the seed fragments went to a shaking separator, which performed a preliminary job of removing the hulls from the mix. Final separation took place in a rolling separator that screened the seeds in a rotating drum. The hulls tended to stick to one another and so became too large to

fall through the screen of the drum with the kernel fragments. The hulls removed at this point were a marketable commodity themselves, being used as animal feed or fertilizer. Alternatively, they could be used as fuel for the plant's boilers.

From separating, the kernels went to crushers. The purpose of this stage was not to squeeze oil from the meat, but to break the oil cells in them and so improve their yield. Crushers consisted of vertically stacked rollers. The kernel pieces entered at the top and emerged as a meal ready for cooking, the stage that prepared the kernels for pressing. The cooking heater

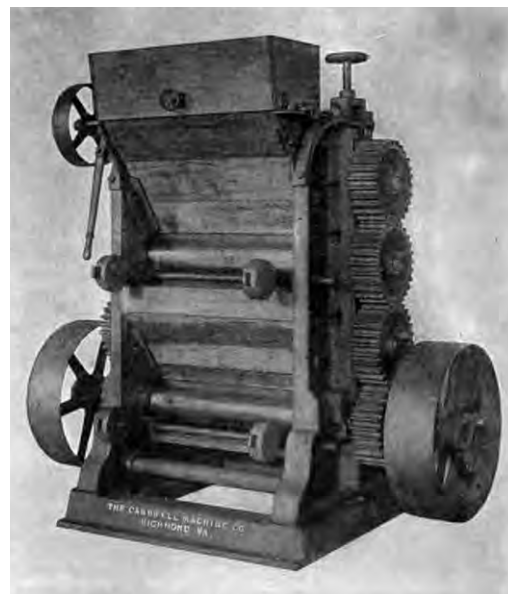

Crusher  
(Lamborn  
1904).



Cottonseed Cakes Being Ground Into Meal After Pressing. Clarksdale, Mississippi, 1939 (Library of Congress).

incorporated a large metal tank, steam heater, and mechanical stirrer to prevent clumping. Cooking involved heating the kernels with injections of steam. While still hot, the cooked kernels went to the cake former, a machine that molded the meal into slabs approximately 14 inches wide and up to five feet long.

These units went on to pressing, where the oil was finally extracted. Pressing machines contained a series of stacked steel plates or pans (10 to 15 or 7 to 12, depending on the size of the machine's hydraulic ram). Each plate contained a corrugated inset with drainage holes. Once loaded with the meal cakes, the hydraulic pressure was switched on and the ram or piston at the bottom of the

Cottonseed Oil Press (Brooks 1898).

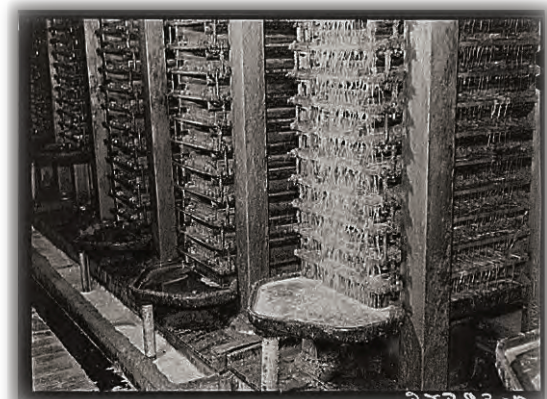
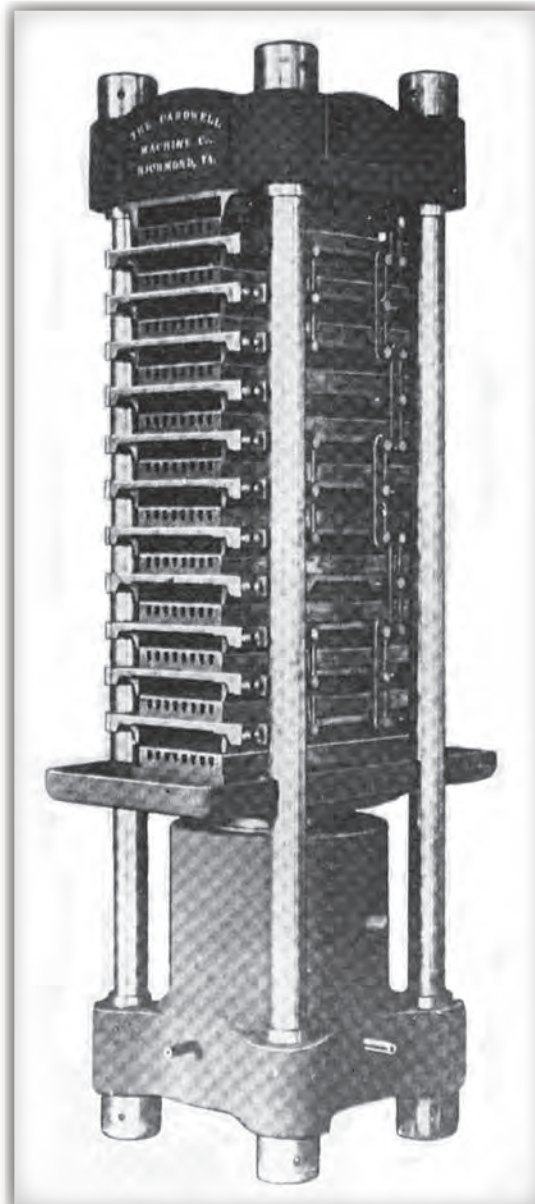

Cottonseed Oil Presses in Operation. Clarksdale, Mississippi, 1939 (Library of Congress).

stack pushed the trays upward into a heavy top plate, in the process squeezing out the oil, which was pumped into settling tanks. From here, any further processing of the oil depended on its intended use. The cakes were removed, ground up, and used as stock feed or fertilizer.

## SITE ORGANIZATION

Although specific information regarding the arrangement of historic cotton gins and cottonseed oil operations were not found for this study, reference to modern examples provided some insight into the requirements of location and organization of space. Decisions about location should consider access to customers and patrons. Therefore, proximity to public roads was important and the site should also be centrally located to the projected service area. Also, the physical constraints of the site had to be taken into account. Areas prone to flooding or that had a high water table or other problems that could affect construction, operation, or access would be avoided. Further, the site required enough space for safe and free operation of the plant as well as for storage of vehicles and materials. Finally, access to power sources and utilities was an important consideration (Baker et al.1994:39). For earlier cotton gins that were owned and operated by individual planters, access for consumers was less of an issue, and Aiken (1998:12) showed them as part of the general group of plantation service buildings clustered near the planter's house and slave quarters. Still, access to transportation would be necessary to get the baled cotton to market.

Organization of the plant site had no single rule but could be dictated by local customs, the shape and size of the property, the location of existing roads, and other factors. Also, if the plant combined different activities, such as producing or selling oil or fertilizer, then these could influence layout. The general requirements were to ensure ample space for the plant along with room for vehicle traffic, parking and storage of loaded and unloaded vehicles, and material storage (Baker et al. 1994:40).

With respect to the interior layout of the plant, there were no set guidelines. However, it was important to plan carefully because once certain structural elements and machinery were in place, they limited options for revision. The plan ideally permitted easy access to the machinery to monitor its operation and to perform maintenance and make repairs. Planners also had to consider factors such as fan locations, length of piping (or shaft and belt) runs, trash collection, and requirements for putting various materials (cotton lint, seeds, etc.) into different processing streams (Baker et al. 1994:41).

Illustrations of typical gins suggest how these facilities would be laid out. Plantation gins normally consisted of two separate functional areas delineated on the basis of processing seed cotton and turning out bales. These functions were housed in separate structures located side-by-side, with the gin house containing not only the gin stand, but also the operating machinery and storage. The ginning process included a logical progression and spatial arrangement of different activities in these gins. Seed cotton was off-loaded at one side of the gin house and lifted to the upper story and stored until it was processed. The cotton lint coming from the gin stand was thrown down to a ground-floor storage room where it waited to be carried across the yard to the press. Illustrations show the lint room on a different side of the gin house than the off-loading area, which would enable a smooth flow of activities (Tomkins 1901).

The ginning system did not dramatically alter the overall linear flow of cotton processing, but did enclose all activities in a single building. Seed cotton was still unloaded at one side of the building, but with the use of pneumatic suction. Unlike at earlier gins, cotton could go directly to the gin stands from the wagon, and the resulting lint was carried to a press located at the end of the battery of stands. Gin houses at this time were most often two-storied structures with the steam plant, shafts, and belting located on the ground floor and cotton processing above (Tompkins 1901).

Cottonseed mills were similarly arranged to move materials forward in a logical and orderly procession. These mills, however, turned out various products besides oil and these different materials went into different streams for handling. Lamborn's (1904:32) plan of an oil mill illustrated the organization of internal space in one of these facilities. Seed and by-products moved through the process via a series of conveyors and elevators. The plan indicated that the mill contained three main parts or rooms: the seed house, which included storage for the seed as it was delivered as well as housing the equipment that performed the initial stages of cleaning. The second building contained the machinery that performed most stages of the process from delinting to pressing. A smaller room, located at the opposite end of the plant from the seed house, contained the machinery for breaking up and grinding the pressed seed cakes. Tanks for settling and oil storage were outside the main building. At various points in the process, marketable by-products were removed for separate treatment. Thus, the residual fibers gleaned from the seed during delinting were delivered at one stage, while the seed hulls were taken away at another. Finally, after pressing oil was drained off in one direction while the seed went in a separate direction to be made into feed or fertilizer. Cotton seed plants ran on steam power and the boiler house was likely situated in a separate building or ell off the main structure. A series of belts suspended above the machinery or below the floor ran the equipment.



## DISTRIBUTIONS AND RESEARCH TOPICS

Of the DOD installations covered by this study, only Robins AFB contains a recorded cotton gin site. Site 9HT45 contained a gin associated with Feagin Plantation/Newberry Farm that was turned into a barn in the 1930s (Hammack, personal communication, 2009). A cotton gin was reportedly associated with Eelbeck/Cook's Mill at Fort Benning. Also, gin machinery fragments at Leslie's Mill on Fort Bragg indicate the presence of a gin house.

A statewide search of the Georgia archaeological site files revealed only 12 recorded cotton gins. Site file data indicate that in many cases, the functional interpretations are based on the presence a standing structure or by inferring a site's presence from historic maps. None of the sites appeared to have been excavated beyond survey level and so do not provide suggestions with respect to what research topics are relevant.

The process and technology of ginning cotton and processing cottonseeds is well documented, and conducting archaeological research on these sites probably has a limited potential to provide significant new information. There might be some variations in the technology, however, that are worth investigating. For example, cotton presses used to make bales at plantation gins are usually described as consisting of wooden boxes that sat in a framework above the ground surface. However, excavations at Andrew Jackson's Tennessee plantation, the Hermitage, indicated he owned a press with a nine-foot deep, brick and limestone-lined pit where the cotton was baled (The Hermitage 2006). The gin house, represented by several postholes, was interpreted as a large log building, a contrast with the frame structures usually depicted. Excavation of plantation cotton gins therefore provides some potential for identifying variation in technology.

Plantation gins can also provide information on plantation landscapes and social relations. First, the location of cotton gins on plantations and their spatial relationships with other features should be identified as part of any effort at better understanding overall plantation settlement systems (Joseph et al. 2004:83). Additionally, studying plantation cotton gins can suggest information about planters and their social/economic positions. Aiken (1998:12) stated that by 1860, all but the smallest plantations owned a cotton gin. This is a statement that can be tested archaeologically. Moreover, if gins were not as common as suggested, then the question is who owned them and what did that say about their economic authority? Presumably, having the ability to gin and bale cotton, and to provide these services to a community, would give a planter substantial influence. Owning a gin--an extremely visible structure-

-would also serve as a symbol of status and influence. On the other hand, if gins were common, then did they have any symbolic meaning? The placement of a gin on the plantation might indicate whether it had symbolic or only economic functions.

After the Civil War, cotton ginning underwent significant changes. Larger, centrally located gins replaced the smaller facilities located on plantations. Newer systems were also associated with new ownership arrangements (Aiken 1998:38). Beginning around 1880, new technology was added to the ginning process. Many of these developments are well understood and archaeology has a limited ability to provide new data. However, archaeology can indicate how new technology was adopted and used. One of the ways to approach this topic is to document sites in detail, determine how they operated, what equipment they used, and how they were organized, and comparing this information to other sites over time and region. This time period is particularly important and interesting to address because of the tremendous economic and social upheavals taking place. These influences provide a set of variables for interpreting various technological innovations and introductions that might have been made.

Cottonseed oil was a relatively late industry in the region and was not as widespread as cotton ginning. Again, the technology involved in the process is well understood. Archaeology can provide data on how and where it was adopted, and how it changed over time. As with cotton gins, examining this issue would entail detailed documentation of sites to better understand how they operated and were organized.





## EVALUATION, MANAGEMENT, AND INTERPRETATION OF INDUSTRIAL SITES IN THE SAND HILLS

This context deals with industrial archaeological sites that existed in the Sand Hills of Georgia, South Carolina, and North Carolina. Previous sections of this document described the contexts associated with each of these industries along with the processes of each, the types of archaeological sites expected to be associated with them, archaeological research that has been conducted, and potential research topics. This chapter presents guidelines for the NRHP evaluation of rural industrial sites, as well as recommendations for their management and interpretation.

### NRHP EVALUATIONS

The significance of archaeological sites is judged with respect to the four NRHP Criteria. Additionally, sites must be assessed in light of their relationship to historic contexts. Finally, a site's NRHP eligibility is a function of its integrity or its ability to convey its historic significance. In other words, it must not only be a good representative for its historic context, but it must also be in a condition that clearly demonstrates its relationship to the context. For archaeological sites, which are most often significant because of their information potential or research value, having integrity means that the site possesses data necessary to address important research issues. The following sections describe in detail the procedures of evaluating Sand Hills industrial sites with reference to their historic contexts and integrity.

### EVALUATION OF SAND HILLS RURAL INDUSTRIES ARCHAEOLOGICAL SITES WITHIN A HISTORIC CONTEXT

Historic contexts are patterns or trends in history that provide a framework for understanding a specific occurrence, property, or site. They provide a means for relating specific sites back to the broader historical patterns and thus interpreting their meanings and evaluating their significance.



The historic context of this project can be stated as “Archaeology of Rural Industries in the Sand Hills of the Carolinas and Georgia.” This context refers to the historical, technological, economic, and labor developments related to collecting and processing natural resources, farm produce, and metals (in the case of blacksmithing) into commodities. The industries included in this context range from large-scale manufacturing to craftwork. In the Sand Hills, these industries made up substantial components of local and regional economies, and yet are sometimes overlooked in regional histories, which tend to emphasize agriculture, especially as it was practiced under the plantation and tenancy systems. While certain of these industries were subsidiaries of agriculture, all of them were important in their own rights. For example, the southeastern states were major suppliers of—in some cases world leaders in—naval stores, lumber, and kaolin during the nineteenth and early twentieth centuries. The stoneware pottery industry was also significant, not as much for its scale, but for the fact that alkaline glazing, a distinctive southern glaze application and style, arose in the Sand Hills and spread from there. Finally, the Sand Hills represented a unique physiographic region in the southeast that offered specific types of natural resources—water power potential, forests, clays—that were either not found elsewhere or were matched only in a few other regions. Highlighting the industries of the Sand Hills therefore draws attention to their unique and significant role in the historical development of this region.

For this study, the historic context covers general patterns of development and processes associated with each of the Sand Hills industries. The context also emphasized archaeological perspectives of the industries, specifically what kinds of sites are associated with each, how different site types within each industry related to one another functionally, and what research has been done with different site types or topics.

In addition to covering broad trends, historic contexts can encompass one or more “themes” or areas of significance. The National Park Service (1990) defined a theme as a means of organizing sites into coherent patterns based on certain concepts or subjects, such as environment or technology, that have influenced the historic or cultural development of an area. A theme is considered significant if scholarly research can demonstrate it to have been important in American history. For the Sand Hills Rural Industries study, significant themes or areas of significance include Archaeology, Engineering, Ethnic Heritage, Industry, Labor, Landscape, Slavery, Technology, and Transportation. A single site might relate to more than one theme.

To decide if particular sites are significant within the Sand Hills Rural Industries context, five things must be determined (National Park Service 1990:7):

1. What facet of history does the site represent? Because this study deals with archaeological sites, it is worth adding as an alternative question, what research issue could the site provide important information about? (These issues can refer to the local, state, or national levels.)
2. How is the theme of the context significant?
3. What is the site type and is it relevant in illustrating the historic context or addressing the research questions?
4. How does the property represent the historic context through specific historic associations, architectural or engineering properties, or how does it address the research issue through its information potential?
5. Does the property possess the physical features necessary to convey the aspect of history with which it is associated or to address the research issue? This question requires ascertaining which types of sites are associated with the historic context, demonstrating the ways they can represent the theme, and determining integrity (discussed below).

For historic archaeological sites, Townsend, Sprinkle, and Knoerl (1993:27) list “Five Primary Steps in a Criterion D Evaluation” that essentially cover the same process as the above but in a different order that is usually associated with evaluating the significance of archaeological sites. This alternative list requires:

1. Identifying the site’s data set(s) or categories of archaeological, historical or ecological information. (This roughly corresponds to Step 3 above.)
2. Specifying the historic context(s) or the appropriate historical and archaeological framework in which to evaluate the property. (This task is essentially the same as Step 1 above.)
3. Determining the important research question(s) that the site might address. (This is similar to Step 2 above, although it also overlaps with Step 1.)
4. Considering integrity, or whether the site has the potential or known ability to answer the research questions (Step 5 above).
5. Identifying the important information that archaeological study of the site has yielded or is likely to produce. (This corresponds to Step 4 above.)

Although these two slightly different ways of evaluating sites arrive at the same goal, the order of steps that Townsend, Sprinkle, and Knoerl produce illustrates some of the differences in the way archaeological sites are approached in a historic preservation situation. Typically, a primary step in any archaeological evaluation is to determine the type, function, and chronology of a site, along with the data sets (artifacts, features, and patterned relationships between artifacts, features, soil stratigraphy, and/or above-ground remains) that the site contains. Once this information is determined, the site can be related to specific archaeological issues. Integrity receives higher priority than in the first procedure, because archaeological significance, and ultimately decisions as to whether sites (or their information content) should be preserved, depends upon integrity. Archaeological contexts (in the sense of the relationships between finds, their proveniences, depositional matrices, and associated materials [Renfrew and Bahn 2000:50]) are extremely important for archaeological analysis. Without a sure context or good integrity, most archaeological sites have little value for analysis, rendering further evaluation less important. Therefore, while the evaluation process requires first determining a site's significance and then its integrity, in actual practice integrity is sometimes assessed earlier in the process. Specific research issues to which the site might apply are delineated later in the process. This is the approach adopted for this study of Sand Hills Rural Industries.

Archaeological sites at the six DOD installations would most likely be significant within the Sand Hills Rural Industries context under NRHP Criterion D because of their information potential. The historic context in this case would consist of research topics relating to industries in the Sand Hills.

Sites covered in this study could also be significant under the other criteria, although it is thought that Criteria A (associations with historic events) and Criteria C (design/construction) are the most likely to apply. Potential significance under Criterion B (associations with historically important people) is not expected, although research performed for particular sites could reveal such associations.

## INTEGRITY

Integrity is an extremely important concept in evaluating the historic significance of a site or property. The concept refers to the ability of a property to convey its association with a particular historic context. For archaeological sites, "having integrity" typically means that a site has collections of artifacts, features, and other remains whose associations are discernable and that when studied would address important

questions about history or prehistory. Although there are exceptions, without integrity archaeological sites are judged to have limited research value—they cannot convey their association to a historic context—and thus lack significance.

There are seven aspects or qualities of integrity: location, design, setting, materials, workmanship, feeling, and association. The NRHP criteria stipulate that a site must possess at least several or most of these aspects. Which of the aspects of integrity a site must have and how important each one is in evaluating a particular site depends on the nature of the site itself and why it might be significant (National Park Service 1990:44; Townsend et al. 1993:17). The seven aspects of integrity are described below.

## LOCATION

Location is the place where the site was constructed or where the historic event occurred. Archaeological sites almost always have integrity of location. A site's location is often key to understanding its importance, as suggested in the preceding chapters where certain site types were viewed with respect to their physical settings. Archaeological sites lacking integrity of location are typically severely disturbed and would have difficulty meeting the NRHP criteria.

## DESIGN

Design is the combination of elements that create the form, plan, space, structure, and style of a property. This term refers to specific decisions made in the original conception and planning of a site or its historical alteration. It encompasses community planning, engineering, architecture, and landscape architecture and may make reference to organization of space, scale, technology, ornamentation, and materials. While it obviously takes in buildings and structures, design can also include towns, plantations, and landscapes, among other types of resources. For archaeological sites, the concept deals with the patterning of buildings, structures, and and/or other features relative to one another (Townsend et al. 1993:18). An example of integrity of design for Sand Hills Rural Industries would be a mill seat in which all the constituent components—mill house, dam, and millrace—could be observed in their original functional relationships.

Townsend, Sprinkle, and Knoerl (1993:18) note that the degree to which a site's design is intact is important to its ability to convey its associations with historic events or people (Criteria A and B) and is critical to be significant under Criterion C if it is to show its status as a representative of a type, period, method, or



having high artistic value. To qualify for its information potential (Criterion D), integrity of design usually refers to intrasite artifact and feature patterning, or intersite patterning in the case of archaeological districts.

## SETTING

Setting consists of the physical environment of a historic property or site. The concept also deals with the character of the place where a site had its historical associations. Moreover, it refers to how a site was placed and its relationship to surrounding natural and cultural features. Elements to consider in establishing integrity of setting include topographic features, open space, views, landscapes, vegetation, and man-made features. These elements should be assessed to determine how well they represent the physical environment of a site at the time it achieved its historical importance.

In general, for a site to have integrity of setting, its physical environment must look roughly as it did during the site's period of historical significance or perhaps evoke the historic environment. Thus, for example, tar kilns were typically built and operated in isolated, forested areas. An archaeological site reflecting a tar kiln located in a similar setting would have integrity of setting. If the site was surrounded by modern structures, its setting would have no integrity. Integrity of setting is not critical for archaeological sites if they are significant for their information potential. The tar kiln surrounded by modern buildings might still yield important research data on its design, construction, and chronology, making it significant under Criterion D.

## MATERIALS

Materials are the tangible elements combined or deposited during a particular time period and in a specific way to form a historic property. The materials found at a site reveal the decisions made in the site's creation and indicate the availability of certain resources and technologies. The National Park Service (1990:45) notes that indigenous materials often reflect regional building traditions and can also help define a site's sense of time and place. This might be expanded upon to suggest that materials might also reflect systems and technologies of manufacture, transportation, and design, which can be themes of a context.

Under Criteria A and B, integrity of materials must be judged with respect to why a site might be significant. It is a critical aspect in evaluating a site under Criterion C, however, where materials would convey the uniqueness or typical qualities of a site's design and construction. Under Criterion D, integrity of materials is normally expressed as whether or not cultural deposits contain intrusive artifacts and features, how complete the assemblages are, or the quality of artifact and feature preservation (Townsend et al. 1993:19).

## WORKMANSHIP

Workmanship refers to the physical evidence of the crafts of a particular culture or people during any given period in history. The concept covers artisans' labor and skill in constructing or altering a building, structure, object, or site and can apply to an entire property or to individual parts. It is applied to vernacular and sophisticated forms, practices, and finishes and may include common traditions or innovative techniques (National Park Service 1990:45).

Workmanship provides evidence of the technology of craft and illustrates aesthetic principals at the levels of individuals, localities, regional areas, or the nation (National Park Service 1990:45). This aspect of integrity is most often applied under Criterion C, which highlights design and construction. Under Criteria A and B, it is usually most important if the significance of a property is tied to craftsmanship, design, or technology. For archaeological sites, workmanship is mostly considered in connection with the quality of the artifacts or architectural features, as well as the skill required to produce artifacts or structural features. In evaluating significance, the weight given to workmanship depends on the nature of the site and the research questions (Townsend et al. 1993:19-20). For the Sand Hills Rural Industries context, mills sites are the most obvious resources that might require consideration of workmanship. Other site types where workmanship might be important include stills, potteries, and the organization, technology, and transportation aspects of mining, logging, and brickmaking.

## FEELING

Integrity of feeling considers how a resource expresses the aesthetic or historic sense of a particular time period. To have integrity of feeling, a site must contain physical features and characteristics that, when considered together convey the site's historic character or enhance its ability to do so (National Park Service 1990:45).

Similar to integrity of setting, the ability of an archaeological site to have integrity of feeling requires that the general surroundings remain close to the condition they were in during the site's period of significance. If a formerly remote rural industrial site remains isolated, lacks dense and highly visible modern intrusions, and contains remnants of the structures and facilities that make it significant, then the site could be judged to have integrity of feeling.

## ASSOCIATION

Finally, integrity of association concerns the direct link between an important historic event or person and a historic property. A site is considered to have integrity of association if it is the place where an event or activity took place and is sufficiently intact to convey that relationship. It requires physical features that demonstrate the associations and historic qualities (National Park Service 1990:45). Integrity of association is most important under Criteria A and B. Archaeological sites can have integrity of association if they relate to important events or people. It applies to archaeological resources that are "type" sites for specific archaeological complexes or time periods, which can meet eligibility under Criterion A. Such sites define archaeological phenomena or chronology and so are directly associated with events and patterns of history (Townsend et al. 1993:20).

In evaluating sites with reference to Criterion D, the strength of the association between the site's data content and the important research questions must be considered (Townsend et al. 1993:21). For example, within the Sand Hills Rural Industries context, a blacksmith site with exceptional assemblages of tools, raw materials, refuse deposits, and features representing activities at the shop would have a strong association with research questions dealing with how blacksmith shops were organized and operated.

## EVALUATING THE SIGNIFICANCE OF HISTORIC ARCHAEOLOGICAL SITES

Archaeological sites that relate to the Sand Hills Rural Industries context include varied types, functions, chronologies, construction, technologies, and scales. Any site being evaluated for the NRHP would have to be judged on the basis of how well it conveyed its relationship to the context, both for its research value and how well it conveyed aspects of a particular theme. Making this assessment also involves considerations of integrity.

Although it is not possible to predict the specific requirements and steps necessary to evaluate all of the potential site types covered by this study, general procedures can assist in the process. Townsend, Sprinkle,

and Knoerl (1993) provide guidelines for documenting the significance of archaeological sites that help structure the evaluation of sites in the Sand Hills Rural Industries context. The following guidelines are arranged according to the specific NRHP criteria.

#### CRITERION A. HISTORICAL EVENTS/PROCESSES

1. Identify the events with which the property is associated.
2. Document the importance of the events within the broad pattern(s) of history.
3. Demonstrate the strength of association of the property to the event or patterns of events. The site must have existed at the time of and be directly associated with the event or pattern of events.
4. Assess the integrity of the property (the property must convey its historic significance. For archaeological sites it must have well preserved features, artifacts, and intrasite patterning in order to illustrate a specific event or pattern of events in history.)

#### CRITERION B. SIGNIFICANT PEOPLE

1. Identify the important person or people associated with the site.
2. Discuss the importance of the individual within the relevant historic context(s).
3. Demonstrate the strength of the association between the person and the property.
4. Address the site's integrity. For Criterion B, an archaeological site would require that the essential features or settings associated with the important person's life are intact.

#### CRITERION C. DESIGN/CONSTRUCTION

1. Identify the distinctive characteristics of the type, period, or method of construction, master or craftsman, or the high artistic value of the site. The intent of Criterion C is to acknowledge and preserve sites that are significant as representatives of the human



expression of culture or technology, especially architecture, technology, landscape architecture, and engineering.

2. Discuss the importance of the property with respect to the historic contexts that are relevant to it and the applicability of Criterion C.
3. Consider how strongly the property illustrates the distinctive characteristics of the type, period, or method of construction, master craftsman, or the high artistic value of the property.
4. Address integrity. To be eligible under Criterion C a site should have remains that are well preserved and clearly illustrate the design and construction of the building or structure.

#### CRITERION D. INFORMATION POTENTIAL

1. Define the data sets or data categories that apply to the information potential. Data sets can include types of artifacts, types of features, or patterned relationships between artifacts, features, soil stratigraphy, and/or above ground remains. They are identified by archaeologists as having relevance to specific questions or issues about archaeology or history.
2. Identify historic contexts that apply to the site. In most cases the sites covered by this study relate to the Sand Hills Rural Industries context. Sites may also provide important information about significant themes within this context.
3. Document the important research questions or topics the site might address.
4. Taking into account archaeological integrity, evaluate the data sets in terms of their potential and known ability to answer research questions.
5. Specify the important information that an archaeological study of the site has produced or is likely to produce.

## GUIDELINES FOR EVALUATING AND MANAGING SAND HILLS RURAL INDUSTRIAL SITES

Evaluating the significance of Sand Hills industrial archaeological sites involves relating individual resources to the historic context through important research topics and questions. The following sections provide topics for the industries included in this study. These issues form a framework for assessing the research potential of particular sites.

As discussed in the preceding chapters, different levels of investigation have been completed at Sand Hills sites. Mills have been studied in some detail, while the other site types have been considered only minimally, if at all. The topics provided below were suggested by the data gaps identified during the preparation of the preceding chapters and will help organize data for site evaluations. Although it is not possible to anticipate all of potential research domains, some general and specific topics can be stated. These are not expected to be the final word on any particular industry and additional topics will emerge as sites are found and investigated or as individual researchers bring their own interests and experiences to the process of evaluating site significance.

### WATERMILL SITES

Of all the industrial sites covered by this study, water-powered mills have been studied the most extensively at the DOD installations. However, most of the previous research was performed at Fort Gordon as part of a single series of data recovery and documentation projects. Mill sites have been identified at other installations but except for Phase II investigations at certain Fort Benning sites, none have been studied in detail. Saw and gristmills were important industrial enterprises in the Sand Hills from early settlement to the first part of the twentieth century. Yet archaeological study of these sites has not been extensive and further analysis has a potential to provide a better understanding of saw- and gristmilling practices in the Sand Hills, milling technology, mill seat development and construction, and watershed use.

The following research topics or objectives provide guidance for evaluating mill sites.

- Categorize milldam types, distributions, and consider influences that affected their use and locations.
- Determine what types of equipment were used at Sand Hills mills and look for patterns.

- Investigate if there are common factors in landform, stream size, economic considerations, or other variables that might affect mill locations.
- Look at water management throughout a watershed.
- Examine the relationship (physical, economic, social) between mill sites and other industrial and non-industrial sites.

For each of these topics, comparisons can be made between sites within the Sand Hills and between them and sites outside of the Sand Hills.

When evaluating an individual mill site within the Sand Hills Rural Industries context (and any of the other site types), researchers would first identify the data sets the site contains and determine if they are relevant to addressing any of the above topics. Next, identify what significant themes apply to the site. Third, state the specific topics or questions the site can address. Fourth, assess the site's integrity and determine if the data it contains have the ability to address the research topics. Finally, indicate the proposed result of a study of the site in terms of what new information it would generate.

For watermills, sites that would best address the research topics are those with a range of feature types, clear evidence of the use of the landscape, or evidence of the equipment used. Not all sites would necessarily address every topic, and it is possible, for example, that a site with an intact turbine equipment might not be able to provide any information about the dam used for the mill.

## NAVAL STORES

The production and distribution of tar, turpentine, and related products has received some attention from archaeologists, although to date tar kilns are the most commonly identified and reported resource associated with naval stores industries. For this study, most of the known tar kilns are located at Fort Bragg, although examples have been recorded at other installations. Including Fort Bragg, however, the total number of documented tar kilns is very small. Several potential research topics apply to tar making. For turpentine, this industry has not been documented archaeologically at any of the DOD installations and few, if any, sites have been conclusively identified outside the installations.

Research topics judged important for archaeological study of naval stores industries include,

- Determine the density of tar kilns at the Sand Hills DOD installations. Look for differences within the Sand Hills and between the Sand Hills and Coastal Plain.
- Investigate the distributions of tar kilns across the landscape and ascertain if they are consistent throughout the Sand Hills and other areas. Also, do Sand Hills tar kilns cluster as has been documented in the Coastal Plain, or are they mostly isolated?
- Determine what are the chronological markers associated with tar kilns. Look for variation over time in terms of locations and kiln types.
- Consider scales of production. Do different size sites or clustered kilns indicate differences in the scale of production?
- Find and document turpentine distilleries and define the universe of these sites.
- Look for chronological changes in scale of turpentine production and technology.
- Identify domestic sites related to tar and turpentine workers.

In general, the ideal sites for research into tar making would be kilns with clearly defined shapes or styles and examples that contain chronological information. Information on the basic size, shape, and location of kilns would also be important for addressing some of the topics, making nearly all tar kiln sites potentially eligible for the NRHP.

For turpentine distilleries, because these sites are so poorly known, any should be viewed as potentially eligible for their information content. Lack of integrity would be the primary factor making them not eligible for the NRHP. Sites that apply to research about the workers in these industries should have clearly documented inhabitants, either through archaeology or archival sources. Domestic sites where turpentine equipment is found are not necessarily related to this theme unless the equipment clearly belonged to the site's inhabitants.



## LOGGING

Logging was an extensive and important industry in the southeast after the Civil War and into the twentieth century, but little archaeological study of it has been done. The description of logging processes and components indicated that three principal activity areas existed: work areas, which included places for felling, cutting up trees, and storing them for shipment; transportation facilities; and residential camps. None of these types has been clearly or extensively identified in the Sand Hills.

Research priorities for logging industries include,

- Identify and map the principal site types and look for variation within and between regions.
- Document and map features and sites related to transportation. Determine how they relate to one another and to other logging site types within the landscape.
- Determine the archaeological manifestations of logging work areas and map them if they exist.

The three principal site types or activity areas related to logging have varying potential for archaeological research and therefore different degrees of significance. It is anticipated that residential camps will have the greatest potential for archaeological research. Sites with clearly defined features and artifact deposits that can provide information on camp organization, equipment, hygiene procedures, and other topics, as stated in the discussion on logging are expected to be NRHP eligible.

Railroads, skidding roads, or other routes can provide data on how a logging operation was organized and arranged across a landscape. Any feature or site related to transportation should be documented and mapped to see how it fits into the larger use of the landscape, although not all of these sites will necessarily be individually NRHP eligible. Work areas are likely to be difficult to discern, and simply identifying the characteristics of such sites is a research objective. If any are found and contain equipment, evidence of activities, and/or show clear relationships to other sites within a logging operation, they would be potentially eligible for the NRHP. If not eligible, they should still be mapped and documented in relation to other logging sites.

## POTTERIES

Pottery making was a common Sand Hills industry in Georgia and South Carolina, though it was not as prominent in the North Carolina Sand Hills. Moreover, alkaline glazed stoneware was a unique product of the South Carolina Sand Hills that was dispersed widely throughout the southeast. In spite of the importance of this industry in the Sand Hills, few sites have been excavated and analyzed in detail. Moreover, archaeologists have recorded few sites in Georgia and the Carolinas, out of hundreds known to have existed. The work that has been completed, however, provides some guidance for future research.

Research topics for Sand Hills potteries include:

- Document site organization and important site elements, such as the kiln and waster dumps.
- Record aspects of kiln technology, including type, dimensions, and construction. Look for evidence of alterations.
- Examine the contents of waster dumps. Wasters can provide important information on the forms produced, the types of glazes used, and may contain stratigraphic integrity that indicates relative chronology as well as changes in forms and glazes.
- Determine if different pottery traditions influenced production at individual sites or regions.
- Consider how potters adjusted to changing markets and technology as well as the availability of new materials, especially glazes.
- Examine locally/regionally made ceramics from non-pottery making sites in the Sand Hills to determine patterns of ceramic marketing, consumption, and distribution.

Site types applicable to these research issues would be individual potteries. To have significance, they would require that kiln remains and/or waster dumps remain present. Ideally, evidence for additional features related to the preparation of clay and other activities would also exist. To date, the pug mills, shops, glazing, and drying areas have not been widely documented at archaeological sites reflecting potteries.

## BRICK MANUFACTURE

Though not unique in the Sand Hills, brickmaking was a local industry that tended to service small areas. None of the DOD installations contains known brickyards, although it is possible that small or temporary yards (set up for specific construction projects) are present. The archaeology of brickmaking in general has tended to focus on the kilns with little attention given to other aspects of manufacturing. If any brickyards are identified at the DOD installations, they have a potential to produce important information about rural industries in the Sand Hills.

Research topics for evaluating brickyards in the Sand Hills include,

- Develop a database of sites and map their locations and internal arrangement.
- Look beyond the kiln to identify additional features and activity areas related to the brick making operation.
- Determine what clay mining and mixing, brick molding, drying, and firing procedures were common in a given region or throughout the Sand Hills.
- Identify the kinds of kilns, mixing and molding techniques, and transportation systems Sand Hills brickyards used.
- Address whether permanent or temporary (project-specific) brickyards were the most common.
- Analyze bricks made at individual sites to ascertain the scale and quality of production at individual brickyards.
- Analyze brickyard organization and layout as an industrial workplace to gain insight into the work of brickmakers and employees.

Sites that would be considered significant include those with well-preserved evidence of manufacturing processes. Specific features expected to survive include kilns, clay mines, and possibly mixing and molding areas. Transportation facilities and molding and mixing equipment might also be present. Because so little is known about Sand Hills brickyards from direct archaeological evidence, sites with only one or two

extant features, say a kiln and/or molding area, might still be significant because they could address some of the research topics.

## BLACKSMITHING

Blacksmithing was a craft industry practiced everywhere people settled. This industry was a critical component of rural--and urban--life as blacksmiths supplied and repaired the hardware necessary for all kinds of activities. Few blacksmith shops have been examined archaeologically in the southeast and only one has been recorded at the six DOD installations covered by this study. The research potential of sites representing blacksmith shops was suggested by the research conducted thus far and the nature of the southern economy and society.

Research topics for blacksmithing in the Sand Hills study area include,

- Examine distributions of rural blacksmith shops. This topic considers how they served their communities and how large the typical service area measured.
- Identify patterns in the internal organization of blacksmith shops. Determine if they are consistent or how they vary.
- Document forge dimensions, construction materials, and styles.
- Determine sources of raw material.
- Identify what features can be related to various functional activities and spaces within the shop.
- Delineate the workspaces and discrete functional areas in shops. This information can indicate the types of services individual blacksmiths provided.
- Compare the shop organization, activities, equipment, and products between antebellum and postbellum shops. Additionally, make comparisons between slave and free blacksmiths.
- Consider what impacts changing technology and industrial production of iron tools and equipment had on rural blacksmithing.



The types of sites and features that would be significant for addressing these questions include those with well-preserved structural features, features related to various shop functions, and artifact deposits. However, some of the topics deal only with specific features or artifacts. Thus, a site containing only remains of the forge could still provide information on type and construction. Similarly, a disturbed site that contained iron stock could provide information through metallurgical analysis on the origins of this raw material. The research topics provide guidance as to what data to collect from individual sites.

## DISTILLING

Liquor distilling comprised an important component of rural industries from the early periods of settlement into the twentieth century. The process turned grain into a commodity that was relatively easy to preserve and transport and was highly saleable. Both legal and illegal distilleries existed. While no commercial distilleries are known from the DOD installations, and it is not known if any existed in these areas, illicit moonshine stills have been documented. None, however, have been completely excavated and have been identified primarily on the basis of location and scattered artifacts. Archaeology of moonshining sites has a strong potential to indicate how this small-scale craft industry was manifested in the Sand Hills and how it adapted to new technology and legal parameters.

Research topics for stills include,

- Categorize the equipment and technology used. Did they change over time or location?
- Determine if moonshiners adopted new types of technology or adhered to traditional methods.
- Categorize site locations with reference to the illicit and secretive aspects of moonshine production. How did Sand Hills moonshiners deal with landscapes containing fewer natural hiding places than the mountainous areas to the west?
- Determine the distributions of moonshine stills throughout the region. Do they show concentrations at specific areas that would have provided markets for their products or are they distributed with regard to other influences?

Sites with the best potential for addressing these questions are those with the most integrity. Specifically, sites with relatively intact assemblages of distilling equipment and associated features, tools, and supplies would indicate the technology and methods employed for moonshining. Information about site locations and distributions could be determined from survey and documentation projects.

## MINING

Kaolin, bauxite, and fuller's earth represented mineral resources that were closely associated with the Sand Hills. These resources were extensively mined and shipped out of the region for their use in other manufacturing industries, leading to the Sand Hills becoming a world leader in kaolin exports at one time. The industry remains important in some areas to the present but little is known about its early development from the standpoint of its material remains. Although archaeological resources representing mines have been identified in the Carolinas and Georgia, these have been in other regions, dealt with other resources, and most sites have been described as only prospecting holes or surface mining pits. The study of mining in general, and Sand Hills mines in particular, could benefit from additional research that takes into account not only the excavation areas but the processing, transportation, and support systems.

Topics to guide research and relate these sites to the historic context include,

- Determine what mining sites consist of besides the mine pit. Identify excavation, processing (e.g., drying and refining), and transportation facilities as well as administrative and housing areas, if they existed.
- Identify the technologies used to excavate and move materials throughout and away from mine sites.
- Examine distributions of mines in the landscape and consider if they reflect or were influenced by natural conditions and/or social and economic factors.
- Delineate changes to technology used in Sand Hills mines. Did new equipment and technology appear? Was it adopted or resisted?
- Investigate whether Sand Hills mines utilized local labor or brought in workers and housed them in dedicated villages or settlements.

## COTTON GINS

Cotton ginning was a prevalent industry in the southeast beginning in the early part of the nineteenth century and continuing to the present. The industry first emerged as part of the plantation-based economy and later became a common part of towns and cities throughout the region. Processing of cotton took on an increasingly more industrial quality as its organization, financing, and operation switched from plantations to becoming more closely associated with in-town merchants and commercial interests. Presumably, cotton ginning in the Sand Hills resembled that of other areas. Nevertheless, this industry must be included in any discussion of Sand Hills industries because of its ubiquity and economic significance. Cottonseed oil production, a later industry, was not as common as ginning but had made important contributions to the regional economy and landscape as entrepreneurs looked for ways to make greater profits from farm produce. Cotton gins and cottonseed oil plants are rare in the archaeological record, with none having been formally recorded at any of the DOD installations and few being identified outside of them. Archaeological research has a potential to illuminate aspects of the technology, locations, and meanings of these industrial sites.

Research topics for evaluating cotton gin sites include,

- For plantation gins, determine if the technology and equipment was consistent for all regions and time periods. Look for variations to identify regional traditions/preferences and how the gin house and bale screw evolved.
- Look at distributions of plantation gins and assess how common they were. Compare results to archival and secondary sources that state nearly all plantations had them. Were they actually this common or did only certain plantations contain gins?
- Map the locations of cotton gins within the plantation landscape. Do their locations indicate any symbolic meanings or only economic functions?
- For post-Civil War gins, investigate how and when new technologies, equipment, and organizational methods were introduced into cotton regions. This issue would involve documenting gin sites in detail, determining how they operated, what equipment they used, how they were organized and arranged, and comparing these over time and location.

- For cottonseed oil, investigate how and where this industry was adopted and how it changed with the introduction of new technology.

Ideal sites for addressing these questions would be those with relatively intact groups of features representing the various structures and activities associated with cotton and cottonseed processing. Although artifacts representing tools and other implements would not be expected, machinery parts and structural remains could be found that would indicate the types of technologies and equipment used at particular sites.

## MANAGEMENT CONSIDERATIONS

In most instances, site significance will be determined through an archaeological evaluation study during which the site is examined, its chronology, function, and integrity are ascertained, and its research potential is assessed. Industrial sites in the Sand Hills that are considered significant should have qualities that can be used to address the research topics presented above or others that might be determined. Sites that are considered significant and therefore eligible for the NRHP for their information potential warrant preservation, either in place or through data recovery projects. Preservation in place can entail long-term regular monitoring of site conditions, stabilization, marking or fencing off site boundaries, and other tasks.

Another consideration for resource management is dealing with sites that lack individual significance but that combined form significant historic districts. Examples that emerged from this study are tar kilns, moonshine stills, and kaolin mining complexes. A historic "district possesses a significant concentration, linkage, or continuity of sites, buildings, structures, or objects united historically or aesthetically by plan or physical development" (National Park Service 1990:5). Although they exhibit some variation, tar kilns tend to be fairly repetitive and, thus far, individual examples have yielded only small amounts of information. However, they are highly visible features and when viewed together they show a distinctive and patterned use of the landscape for a particular economic activity that was highly important in the region. Similarly, individual moonshine stills would not necessarily generate significant data but together they may reveal patterns associated with behaviors, markets, or other influences. Mining operations, as discussed in a previous chapter, might include separate but related components dispersed over a large area. Facilities associated with a single mine or mining venture might receive individual designations but



their historic importance could be enhanced and conveyed more clearly by grouping them into a historic district if they meet other criteria of significance.

Finally, a benefit of developing a historic context based on research questions is that it helps not only in the identification of significant archaeological resources, but also guides general data collection. Sites lacking integrity, that are ephemeral, or that have low information potential because they are isolated or simple constructions, can still contribute bits of information that can be fit into broader inquiries. Examples of such sites include:

- Earthen dams not directly associated with mills but used for water control within a drainage basin,
- Mill ruins that no longer have clear associations with a dam and race but still contain a waterwheel or turbines,
- Logging road and railroad segments, skidways, felling and bucking areas,
- Isolated turpentine trees, isolated turpentine collecting equipment,
- Blacksmith forges or iron stock from sites where the remainder of the shop has been destroyed,
- Moonshine stills that have poor integrity but that are still discernable as to function and/or chronology,
- Isolated borrow pits or mines for brick, pottery, or kaolin operations.

Long-term preservation of these sites would not be necessary. However, documenting such sites can provide some information needed to address important research into Sand Hills industries. This context highlights some of the site types and resources archaeologists working the Sand Hills should be aware of and what information would be useful to collect from them.

## SITE INTERPRETATION

Industrial sites on the Sand Hills DOD installations have interpretive values for connecting the historic resources of an installation to the local community as well as for conveying historical use of the landscape to the forces training and operating at these facilities.

Industrial sites typically have greater community awareness than residential sites. Mills, factories, lumber camps, potteries, brickyards, and mines were all locations where community residents purchased industrial products as well as sites where area residents found employment. Along with stores, churches, and cemeteries, rural industrial sites are thus places of memory to the former residents of the DOD installations and their descendants.

Industrial sites and resources have interpretive potential for installation's cultural resource management program websites, demonstrating the types of industries once present on a facility's location. For example, Fort Bragg's Cultural Resource Management Program home page ([www.bragg.army.mil/culturalresources/](http://www.bragg.army.mil/culturalresources/)) includes illustrations of a Hurty cup and cat-faced and boxed turpentine trees on the main page, emphasizing Fort Bragg's association with the naval stores industry to site visitors. Fort Benning's page ([www.benning.army.mil/emd/program/cultural\\_resources/index.htm](http://www.benning.army.mil/emd/program/cultural_resources/index.htm)) includes images and text on Eelbeck Mill. The Sand Hills DOD installations may wish to consider adding or expanding their web-site context on rural industries.

Brochures offer another vehicle for Sand Hills installations to convey their recognition and management of industrial sites that are elements of their region's histories. Brochures on the naval stores industry of Fort Bragg and historic milling at Fort Gordon are worthy of consideration, since both of those installations have completed multiple studies on their respective industries that offer strong outreach value.

Preserved rural industrial sites offer points of interest to the public during heritage days. Mill sites in particular, since these were frequently located on road systems, offer places for visitation and discussions of the installation's historic landscape. If industrial sites are located in areas that are publicly accessible on a routine basis, interpretive signage should be considered as a means of passively presenting the history of such sites.

The DOD installations may wish to consider oral history programs as a means of furthering public outreach on rural industries as well as expanding the knowledge of these sites. Oral history has been used to a limited extent on Fort Gordon's mills and on Fort Bragg's Overhills tract, with good results. Oral history

programs geared toward specific industries at Sand Hill installations and in their regions offer means for establishing beneficial public partnerships. For example, Robins AFB could partner with the Crawford County Historical Society for an oral history study of the potteries of Crawford County that would benefit the local community and build upon the historical context established in this volume.

Finally, it is hoped that this context and the Sand Hills Rural Industries poster that was also developed for this Legacy project will provide installation Cultural Resource Managers with additional tools for providing the public and the military with information on the Rural Industries of the Sand Hills. As part of this study, a pamphlet will be developed for distribution to all the participating installations that summarizes the Sand Hills Rural Industries Context and how each installation contributes to a better understanding of this significant component of southern history and archaeology.



## REFERENCES

Abbot, Lawrence E., Jr., Erica E. Sanborn, Mary Beth Reed, and John S. Cable

1995 *Archaeological and Historical Background Research Report: Fayetteville Outer Loop, I-95 to NC 24, NCDOT TIP No. U-2519, Cumberland, Hoke, and Robeson Counties, North Carolina: Archaeological Survey Within the Cape Fear River Valley*. Report Submitted to H.W. Lochner Inc., Raleigh, North Carolina, by New South Associates, Inc., Stone Mountain, Georgia.

Adams, Natalie P.

2002 *A Pattern of Living: A View of the African American Slave Experience in the Pine Forests of the Lower Cape Fear*. In *Another's Country: Archaeological and Historical Perspectives on Cultural Interactions in the Southern Colonies*, edited by J.W. Joseph and Martha Zierden, pp. 65-78. University of Alabama Press, Tuscaloosa.

Adams, Natalie P., Leslie E. Raymer, J.W. Joseph, and Bonnie Frick

2001 *Phase I Archaeological Survey of 4,219 Acres, Lake Thurmond, McDuffie, Lincoln, Wilkes and Columbia Counties, Georgia and McCormick County, South Carolina*. Report submitted to U.S. Army Corps of Engineers, Savannah, Georgia, by New South Associates, Inc., Stone Mountain, Georgia.

Adams, Natalie P., Keith Seramur, and Johannes Loubser

2006 *Intensive Archaeological Survey of Proposed Expansion Areas at the Alvin W. Vogtle Nuclear Plant, Burke County, Georgia*. Report Submitted to Tetrattech NUS, Aiken, South Carolina, by New South Associates, Inc., Stone Mountain, Georgia.



Aiken, Charles S.

- 1973 The Evolution of Cotton Ginning in the Southeastern United States. *The American Geographical Society of New York*, April: 196-224. On file at Hargrett Library, University of Georgia, Athens.
- 1989 Cotton Gins. In *Encyclopedia of Southern Culture*, edited by Charles Reagan Wilson and William Ferris, pp. 568-569. The University of North Carolina Press, Chapel Hill.
- 1998 *The Cotton Plantation South Since the Civil War*. The Johns Hopkins University Press, Baltimore, Maryland.

Anderson, David G., J.W. Joseph, and Mary Beth Reed

- 1988 *Technical Synthesis of Cultural Resource Investigations, Fort Polk, Louisiana*. Report funded by United States Army, Fort Polk, Louisiana, and The National Park Service, Interagency Archaeological Services, Atlanta. Prepared by Garrow & Associates, Inc., Atlanta, Georgia.

Baker, R.V., D.W., VanDoorn, and B.M. Norman

- 1994 Site Selection, Facility, and Machinery Arrangement. In *Cotton Ginner's Handbook*, edited by W.S. Anthony and William D. Mayfield, pp. 39-42. U.S. Department of Agriculture, Washington, D.C.

Baldwin, Cinda K.

- 1993 *Great & Noble Jar: Traditional Stoneware of South Carolina*. The University of Georgia Press, Athens.

Becher, Matthew E.

- 2000 A Forgotten Industry: Investigating a Nineteenth Century Rural Distillery. Ohio Archaeological Council. Electronic document <[www.ohioarchaeology.org](http://www.ohioarchaeology.org)>. Viewed June 25, 2009.

Bishir, Catherine W., Charlotte V. Brown, Carl R. Lounsbury, and Ernest H. Wood, III

- 1990 *Architects and Builders in North Carolina: A History of the Practice of Building*. The University of North Carolina Press, Chapel Hill.

Bizzell, O.M., editor

- 1983 *The Heritage of Sampson County, North Carolina*. North Carolina Historical Society and Hunger Publishing Company, Winston-Salem, North Carolina.

Blanton, Dennis B., and Mary Beth Reed

- 1987 *Archaeological Testing and Survey at Robins Air Force Base, Warner Robins, Georgia*. Report for Robins Air Force Base, Warner Robins, Georgia and National Park Service, Atlanta, by Garrow and Associates, Inc., Atlanta.

Botwick, Brad, and Natalie P. Adams

- 2003 *Phase I Archaeological Survey of the Oconee Connector Trail Construction Project, Oconee County, South Carolina*. Report submitted to Palmetto Conservation Foundation, Spartanburg, South Carolina, by New South Associates, Inc., Columbia, South Carolina.

Botwick, Brad, Karen Serio, Lisa O'Steen, Mary Beth Reed, Theresa Hamby, and J.W. Joseph

- 2003 *Phase I Cultural Resources Survey of 107 Acres on Rae's Creek, Richmond County, Georgia*. Report Submitted to US Army Corps of Engineers, Savannah, Georgia by New South Associates, Inc., Stone Mountain, Georgia.

Botwick, Bradford, Mark Swanson, Keith C. Seramur, Anthony Love, Shawn Patch, David Price, and J.W. Joseph

- 2009 *Archaeological Data Recovery of Site 1Mb418, Gulf Brick and Tile Factory, Thyssenkrupp Steel and Stainless Mill Project, Mobile and Washington Counties, Alabama*. Prepared for MACTEC Engineering and Consulting, Inc., Birmingham, Alabama, by New South Associates, Inc., Stone Mountain, Georgia.

Boucherie, Anthony

- 1819 *The Art of Making Whiskey*. Worsley and Smith, Lexington, Kentucky.

Bowen, William R., and Linda F. Carnes

- 2002 Historical and Archaeological Investigations of an Atlanta Folk Pottery: The Rolander Site. *Early Georgia* 30(2):195-208.

Brashler, Janet G.

- 1991 When Daddy Was a Shanty Boy: The Role of Gender in the Organization of the Logging Industry in Highland West Virginia. *Historical Archaeology* 25(4):54-68.

Braley, Chad O.

- 1993 *Cultural Resources Survey of Selected (FY91) Timber Harvesting Areas on Fort Jackson, Richland County, South Carolina*, Volume I: Report. Prepared for US Army Corps of Engineers, Savannah, Georgia and The Directorate of Engineer and Housing, Fort Jackson, South Carolina by Gulf Engineers & Consultants, Inc., Baton Rouge, Louisiana, and Southeastern Archaeological Services, Inc., Athens, Georgia.

- 1994 *Archaeological Survey and Testing, Wilkerson Dam and Lake, Fort Gordon, Georgia*. Report prepared for US Army Corps of Engineers, Savannah, Georgia and Environmental Resources Division, Fort Gordon, Georgia, by Gulf Engineers & Consultants, Inc., Baton Rouge, Louisiana, and Southeastern Archaeological Services, Inc., Athens, Georgia.

Braley, Chad O., and Peggy S. Froeshauer

- 1991 *The Archaeological and Architectural Investigations at the Boardman Dam and Pond Site, Fort Gordon, Georgia*. Report prepared for US Army Corps of Engineers, Savannah, Georgia and Environmental Resources Division, Fort Gordon, Georgia, by Gulf Engineers & Consultants, Inc., Baton Rouge, Louisiana, and Southeastern Archaeological Services, Inc., Athens, Georgia.

Breen, Eleanor E., and Esther C. White

- 2006 "A Pretty Considerable Distillery": Excavating George Washington's Whiskey Distillery. *The Quarterly Bulletin of the Archaeological Society of Virginia* 61(4):209-220.

Britton, Karen Gerhardt

- 1992 *Bale O' Cotton: The Mechanical Art of Cotton Ginning*. Texas A&M University Press, College Station, Texas.

Brooks, Christopher P.

- 1898 *Cotton: Its Uses, Varieties, Fibre Structures, Cultivation, and Preparation for the Market as an Article of Commerce, also the Manufacture of Cotton Seed Oil, Cotton Seed Meal and Fertilizers*. Spon and Chamberlain, New York, New York.

Bryant, Ralph Clement

- 1913 *Logging: The Principals and General Methods of Operation in the United States*. John Wiley & Sons, Inc., New York.
- 1922a *Lumber: Its Manufacture and Distribution*. John Wiley & Sons, New York.
- 1922b *An Outline for a Field Study of a Lumber Operation*. New Haven, Connecticut. (Originally published 1912.)

Burgess, Malcolm S., Sr.

- 1985 *Kaolin: A Glacier's Gift to Georgia*. Privately published manuscript on file at Hargrett Library, University of Georgia, Athens.

Burrison, John A.

- 1983 *Brothers in Clay: The Story of Georgia Folk Pottery*. The University of Georgia Press, Athens.

Carnes-McNaughton, Linda F.

- 1997 *Transitions and Continuity: Earthenware and Stoneware Pottery Production in Nineteenth Century North Carolina*. Ph.D. Dissertation, University of North Carolina, Chapel Hill.



Carpenter, P.A., III, Jeffrey C. Reid, and Charles H. Gardner

1995 North Carolina, U.S.A.: An Industrial Mineral Storehouse. In *Proceedings of the 28<sup>th</sup> Symposium on Industrial Minerals*, Compiled by Brian J. Walker, pp. 65-70. West Virginia Geologic and Economic Circular C-46, Martinsburg, West Virginia.

Carruth, Amy, Warren Carruth, Jon Glass, Jeremy Hicks, Kenny Pearce, and Paul Jackson

2007 *Phase II Investigations of 30 Sites for the Machine Gun and Rhinehart Road Ranges, Fort Benning Military Reservation, Muscogee County, Georgia* (Draft). Prepared for Department of the Army, Headquarters United States Army Infantry Center, Fort Benning, Georgia, by Panamerican Consultants, Inc., Tuscaloosa, Alabama.

Casterlin, Warren S.

1914 *Steel Working and Tool Dressing*. M.T. Richardson Co. Publishers, New York, New York.

Central of Georgia Railway Industrial Department

n.d. *Some of the Kaolin and Refractory Clay Deposits of Wilkinson County, Georgia*. Savannah. Pamphlet on file at Hargrett Library, University of Georgia, Athens.

China Clay Producers Association

2007 Web Site of the China Clay Producers Association. <[www.kaolin.com/ccpros.html](http://www.kaolin.com/ccpros.html)>. Accessed July 9, 2009.

Clark, William Z., Jr., and Arnold C. Zisa

1976 *Physiographic Map of Georgia*. Department of Natural Resources, Atlanta.

Coastal Carolina Research

1997 *Excavations at a Blacksmith Shop at Clear Run Plantation, Sampson County, North Carolina*. Report for North Carolina Department of Transportation, Raleigh.

Cobleigh, Rolfe

1914 *Farm Devices and How to Make Them*. Orange Judd Company, New York.

Coleman, Kenneth, editor

1991 *A History of Georgia*. The University of Georgia Press, Athens.

Compton, Wilson

1916 *The Organization of the Lumber Industry*. American Lumberman, Chicago, Illinois.

Cowie, Sarah E.

2000 *Early Settlement and Industry in Georgia and Alabama: Archaeological Testing of Five Historic Sites on the Fort Benning Military Reservation*. Prepared for US Army Infantry Center, Directorate of Public Works, Fort Benning, Georgia, by Southern Research, Historic Preservation Consultants, Inc., Ellerslie, Georgia.

Culpepper, William S.

2006 *Known Tar Kilns and Cat-Faced Trees with the 1919 Property Plat Map*. On file at Department of Public Works, Fort Bragg, North Carolina.

Dawson, Audrey R., Christopher Ohm Clement, and Deborah A. Keene

2007 *Archaeological Research at Sixty-One Sites, Fort Jackson, South Carolina*. Applied Research Division, South Carolina Institute of Archaeology and Anthropology, University of South Carolina, Columbia.

Dedrick, B.W.

1924 *Practical Milling*. National Miller, Chicago, Illinois.

Dergane, Christopher

1976 Wilkerson and Son Brick Works Historic American Engineering Record Documentation. On file, Library of Congress, Washington, D.C.

Diemer, John A. and Andy R. Bobyarchick

2005 Land Regions, the North Carolina Atlas Revisited. Electronic document <<http://www.ncatlasrevisited.org/homefrm.html>>. Accessed September 1, 2009.

Edgar, Walter

1988 *South Carolina, A History*. University of South Carolina Press, Columbia.

Espenshade, Christopher T.

2002 Taming the Groundhog: Excavation at the Sligh Stoneware Pottery, Paulding County, Georgia. *Early Georgia* 30(2): 183-194.

Evans, Oliver

1848 *Young Mill-Wright and Miller's Guide* (Twelfth Edition). Lea and Blanchard, Philadelphia, Pennsylvania.

Feister, Lois M. and Joseph S. Sopko

1996 Eighteenth and Early 19<sup>th</sup> Century Brickmaking at the John Jay Homestead: The Process, Products, and Craftsmen. *Northeast Historical Archaeology* 25:51-68.

Foy, Jessica

1989 Moonshine and Moonshining. In *Encyclopedia of Southern Culture*, edited by Charles Reagan Wilson and William Ferris, pp. 696-697. The University of North Carolina Press, Chapel Hill.

Franzen, John G.

- 1992 Northern Michigan Logging Camps: Material Culture and Worker Adaptation on the Industrial Frontier. *Historical Archaeology* 26(2):74-98.

Gamble, Thomas, editor

- 1922 *Naval Stores: History, Production, Distribution, and Consumption*. Review Publishing and Printing Company, Savannah, Georgia.
- 1928 Words and Expressions Used in the Naval Stores Industry and Their Meanings. *Gamble's Naval Stores Year Book*, 1928-29. Copy on file at Hargrett Library, University of Georgia, Athens.
- 1929 Making Turpentine and Rosins in the South Seventy-Eight Years Ago. *Gamble's Naval Stores Year Book*, 1929-30. Copy on file at Hargrett Library, University of Georgia, Athens.

Gradie, Robert R. III, and David A. Poirer

- 1991 Small-Scale Hydropower Development: Archaeological and Historical Perspectives from Connecticut. *IA, The Journal of the Society For Industrial Archaeology* 17(2):47-66.

Gray, Jay, and Charles H. McNutt, Jr.

- 2004 *Phase I Intensive Archaeological Survey of 1,457.5 Hectares (3,600 Acres), NTA 2, NTA 3, RR, and NCA Study Areas, Fort Bragg Military Reservation, Cumberland and Harnett Counties, North Carolina*. Prepared for U.S. Army Corps of Engineers, Champaign, Illinois by Panamerican Consultants, Inc., Memphis, Tennessee.

Greeley, Horace, Leon Case, Edward Howland, John M. Gough, Philip Ripley, F.B. Perkins, J.B. Lyman, Albert Brisbane, and M.K. Hall

- 1873 *The Great Industries of the United States: An Historical Summary of the Origin, Growth, and Perfection of the Chief Industrial Arts of this Country*. J.B. Burr & Hyde, Hartford, Connecticut.



Greer, Georgeanna H.

1981 *American Stonewares: The Art and Craft of Utilitarian Potters, Revised 3<sup>rd</sup> Edition*. Schiffer Publishing, Ltd., Atglen, Pennsylvania.

Gresham, Thomas H.

1982 *Known Cultural Resource Site Inventory, Fort Benning Military Reservation, Alabama and Georgia*. Submitted to US Army Corps of Engineers, Savannah, Georgia, by Southeastern Wildlife Services, Inc., Athens, Georgia.

Grover, Jennifer E., Kenny R. Pearce, and Meghan LaGraff Ambrosino

1997 *Archaeological Testing at Ten Sites at Fort Gordon, Georgia*. Report prepared for Department of the Army, Corps of Engineers, Savannah, Georgia, by Panamerican Consultants, inc., Tuscaloosa, Alabama.

Gurke, Karl

1987 *Bricks and Brickmaking: A Handbook for Historical Archaeology*. University of Idaho Press, Moscow.

Hardesty, Donald L.

1988 *The Archaeology of Mining and Miners: A View from the Silver State*. Historical Archaeology Special Publication Series, Number 6. Society for Historical Archaeology.

Harmon, Michael A., and Rodney J. Snedeker

1993 The Archaeological Record of Tar and Pitch Production in Coastal Carolina. In *Historical Landscapes in South Carolina: Historical Archaeological Perspectives of the Land and Its People*, edited by Linda F. Stine, Lesley M. Drucker, Martha Zierden, and Christopher Judge, pp. 100-122. Council of South Carolina Professional Archaeologists, Columbia.

The Hermitage

2006 Archaeology. Electronic Document <<http://www.thehermitage.com>>. Accessed October 1, 2009.

Hewitt, Mark

1995 Stuck in the Mud: The Folk Pottery of North Carolina. *Ceramic Review* 151:30-33

Hewitt, Mark, and Nancy Sweezy

2005 *The Potters Eye: Art and Tradition in North Carolina Pottery*. The University of North Carolina Press, Chapel Hill.

Holmstrom, J.G.

1904 *Modern Blacksmithing*. Frederick J. Drake & Co. Publishers. Chicago, Illinois.

Howell, Charles

1975 Colonial Watermills in the Wooden Age. In *America's Wooden Age: Aspects of its Early Technology*, edited by Brooke Hindle, pp. 120-159. Sleepy Hollow Restoration, Inc., Tarrytown, New York.

Hunter, Louis C.

1975 Waterpower in the Age of the Steam Engine. In *America's Wooden Age: Aspects of its Early Technology*, edited by Brooke Hindle, pp. 160-192. Sleepy Hollow Restoration, Inc., Tarrytown, New York.

1979 *A History of Industrial Power in the United States, 1780-1930. Volume One: Water Power in the Century of the Steam Engine*. The University Press of Virginia, Charlottesville.

International Library of Technology

1902 *Cottonseed Oil and Products*. International Textbook Company, Scranton, Pennsylvania.

Jeane, Donald Gregory

1974 *The Culture History of Grist Milling in Northwest Georgia*. Ph.D. Dissertation, Department of Geography and Anthropology, Louisiana State University, Baton Rouge.

1984 *An Archival and Field Survey of Selected Historic Cultural Resources, Allatoona Lake, Georgia*. US Army Corps of Engineers, Mobile, Alabama.

Jordan, William R.

2002 *Archaeological Investigations of Alkaline-Glazed Stoneware Potteries in Northern Washington County, Georgia*. *Early Georgia* 30(2):141-170.

Joseph, J.W., Theresa M. Hamby, and Catherine S. Long

2004 *Historical Archaeology in Georgia*. Georgia Archaeological Research Design Paper No. 14, University of Georgia, Athens.

Kane, Sharyn, and Richard Keeton

2003 *Fort Benning: The Land and Its People*. The US Army Infantry Center, Directorate of Public Works, Fort Benning, Georgia and Southeast Archaeological Center, National Park Service, Tallahassee, Florida.

Kogel, Jessica Elzea, Sam M. Pickering, Jr., Evgenya Shelobolina, Tim Chowns, Jim Yuan, and David Avant, Jr.

2002 *The Georgia Kaolins: Geology and Utilization*. Society for Mining, Metallurgy, and Exploration, Littleton, Colorado.

Kovacik, Charles F., and John J. Winberry

1989 *South Carolina: The Making of a Landscape*. University of South Carolina Press, Columbia. (Originally published by Westview Press, Inc., 1987.)

Ladd, George E.

- 1898 *A Preliminary Report on a Part of the Clays of Georgia*. Geological Survey of Georgia, Bulletin No. 6—A. Atlanta, Georgia.

Lamborn, Leebert Lloyd

- 1904 *Cottonseed Products: A Manual of the Treatment of Cottonseed for Its Products and Their Utilization in the Arts*. D. Van Nostrand Company, New York.

Leffel, James

- 1881 *Construction of Mill Dams*. Noyes Press, Parks Ridge, New Jersey.

Lender, Mark Edward

- 1989 Liquor Industry. In *Encyclopedia of Southern Culture*, edited by Charles Reagan Wilson and William Ferris, pp. 744-745. The University of North Carolina Press, Chapel Hill.

Lewis, Renee, J.W. Joseph, and Mary Beth Reed

- 2009 Historic Mills in the Sand Hills of Fort Gordon. In preparation for publication in *Early Georgia*.

Light, John D.

- 2007 A Dictionary of Blacksmithing Terms. *Historical Archaeology* 41(2):84-157.

Logan, William M.

- 1908 *Clays of Mississippi, Part II: Brick Clays and Clay Industry of Southern Mississippi*. Mississippi State Geological Survey Bulletin No. 4. Jackson.

MacDowall, A.B.

- 1907 Brick. In *The New Werner Twentieth-Century Edition of the Encyclopedia Britannica*, edited by Spencer Baynes and W. Robertson Smith, pp. 250-253. The Werner Company, Akron, Ohio.



Martin, Geoffrey

1913 *Industrial and Manufacturing Chemistry, Organic: A Practical Treatise*. D. Appleton and Company, New York.

McBride, W. Stephen

1987 A Village Blacksmith in the Antebellum South: Archaeological Investigations at the Griswold Shop, Barton, Mississippi (1851-1869). *Southeastern Archaeology* 6(2):79-92.

McCleod, C. Milo, Jennifer Eberlien, Michael Harmon, Richard Newton, and Zane Fulbright

2000 *The Phase II Evaluation of Five Archaeological Sites at Fort Jackson, South Carolina*. Submitted to Fort Jackson, South Carolina, and South Carolina Historic Preservation Office, Columbia.

McVarish, Douglas C.

2008 *American Industrial Archaeology: A Field Guide*. Left Coast Press, Walnut Creek, California.

Messick, Denise P., Johannes Loubser, Theresa M. Hamby, J.W. Joseph, Mary Beth Reed, and Leslie Raymer

1997 *Prehistoric and Historic Excavation at Site 9GW347, Annistown Road Improvement Project, Gwinnett County, Georgia*. Submitted to Gwinnett County Department of Transportation, Lawrenceville, Georgia and Moreland Altobelli Associates, Atlanta, by New South Associates, Inc., Stone Mountain, Georgia.

Miller, Wilbur R.

1989 The Revenue: Federal Law Enforcement in the Mountain South, 1870-1900. *The Journal of Southern History* 55(2):195-216.

Mining Association of South Carolina

2009 Metals and Minerals. Electronic document <<http://www.scmimes.com/index.htm>>. Accessed September 2, 2009.

Mohr, Charles

1897 *The Timber Pines of the Southern United States*. Government Printing Office, Washington, D.C.

Murphy, Carolyn Hanna

1995 *Carolina Rocks! The Geology of South Carolina*. Sandlapper Publishing Co., Inc. Orangeburg, South Carolina.

National Park Service

1990 *National Register Bulletin 15: How To Apply the National Register Criteria for Evaluation*. Washington, D.C.

New York Times

1897 Checking Moonshiners' Work. September 30. Available on line at the New York Times Archive <[www.nytimes.com](http://www.nytimes.com)>. Viewed on June 26, 2009.

Norris, Sean P., Jennifer Langdale, Brad Botwick, Theresa M. Hamby, Alvin Banguilan, and J.H.N. Loubser

2005 *Phase I Cultural Resources Survey of 127 Acres on Rocky Creek, Richmond County, Georgia*. Report Submitted to US Army Corps of Engineers, Savannah, Georgia by New South Associates, Inc., Stone Mountain, Georgia.

North Carolina Sandhills Conservation Partnership

2009 Home Page. Electronic Document <[http://ncscp.org/sandhills\\_region.html](http://ncscp.org/sandhills_region.html)>. Accessed September 2, 2009.

North Carolina State Climate Office

2001 Thunderstorms More Frequent in the Sandhills Region! Electronic document <<http://www.nc-climate.ncsu.edu/climate/sandhills.html>>. Accessed September 2, 2009.

Outland, Robert B., III

2004 *Tapping the Pines: The Naval Stores Industry in the American South*. Louisiana State University Press, Baton Rouge.

Patterson, S.H. and H.H. Murray

1990 Clays. In *Surface Mining* (Second Edition), edited by B.A. Kennedy, pp. 131-152. Society for Mining, Metallurgy, and Exploration, Littleton, Colorado.

Phillips, William

2004 The Cotton Gin. Available on line at the Economic History Services Web Site (EH.net). <<http://eh.net/encyclopedia/article/phillips/cottongin>>. Accessed July 10, 2009.

Powell, William S.

1989 *North Carolina Through Four Centuries*. The University of North Carolina Press, Chapel Hill.

Putnam, Michael

1995 *Silas C. Read Sawmill, Maxwell Lake, North of Range Road, Richmond County, Georgia* (Drawing and Historical Summary). Historic American Engineering Record, National Park Service. On file at Library of Congress, Washington, D.C.

Reed, Mary Beth, J.W. Joseph, and Rita F. Elliott

1994 *Historic Milling on Sandy Run and Spirit Creeks, Fort Gordon, Richmond County, Georgia*. Report Submitted to US Army Corps of Engineers, Savannah, Georgia by New South Associates, Inc., Stone Mountain, Georgia.

Renfrew, Colin, and Paul Bahn

2000 *Archaeology: Theories, Methods, and Practice* (Third Edition). Thames and Hudson, New York.

Rhead, Frederick H.

1910 *Studio Pottery*. Peoples University Press.

Richardson, M.T.

1889 *Practical Blacksmithing*. M.T. Richardson Publishers, New York, New York.

Ries, Heinrich

1897 *Clay Deposits and Clay Industry in North Carolina: A Preliminary Report*. North Carolina Geological Survey Bulletin No. 13. Raleigh.

Ries, H., W.S. Bayley, and Others

1922 *High-Grade Clays of the Eastern United States with Notes on Some Western Clays*. Department of the Interior, United States Geological Survey Bulletin 708. Washington, D.C.

Ries, Heinrich, and Henry B. Kummel

1904 *The Clays and Clay Industry of New Jersey*. Geological Survey of New Jersey. Trenton, New Jersey.

Roberts, Marian D., Eric C. Poplin, and Rick R. Richardson

1992 *Cultural Resources Survey of Selected (FY-91-1) Timber Harvesting Areas, Fort Jackson, South Carolina*. Prepared for US Army Corps of Engineers, Savannah, Georgia, by Gulf Engineers & Consultants, Inc., Baton Rouge, Louisiana, and Brockington and Associates, Inc., Atlanta, Georgia.

Rorabaugh, W.J.

1979 *The Alcoholic Republic*. Oxford University Press, New York.



Rotenstein, David S.

1986 *Traditional Culture in the Twentieth Century: The Architecture and Archaeology of a Rural Blacksmith's Shop*. Georgia Department of Natural Resources, State Historic Preservation Office, Atlanta.

Sass, Jon A.

1990 *The Versatile Millstone, Workhorse of Many Industries*. Society for the Preservation of Old Mills, Knoxville, Tennessee.

Scarlett, Timothy, Jeremy Rahn, and Daniel Scott

2006 Bricks and the Evolving Industrial Landscape: The West Point Foundry and New York's Hudson River Valley. *Northeast Historical Archaeology* 35:29-46.

Schroeder, Paul A.

2003 Kaolin. *The New Georgia Encyclopedia*. Electronic Document <<http://www.georgiaencyclopedia.org>>. Accessed June 29, 2009.

Sellards, E.H.

1914 *Florida State Geological Survey Sixth Annual Report*. Tallahassee.

Shearer, H.K.

1917 *A Report on the Bauxite and Fullers Earth of the Coastal Plain of Georgia*. Geological Survey of Georgia Bulletin No. 31. Atlanta.

Sloan, Earle

1904 *A Preliminary Report on the Clays of South Carolina*. South Carolina Geological Survey Series IV, Bulletin No. 1. Columbia.

1908 *Catalogue of the Mineral Localities of South Carolina*. South Carolina Geological Survey Series IV, Bulletin No. 2. Columbia.

Sloan, Eric

1909 *A Reverence for Wood*. Henry Hold and Company, New York.

Smith, J. Russell

1916 *Commerce and Industry*. Henry Holt and Company, New York, New York.

Smith, Julie Barnes

1992 *The Historic Eelbeck Community, Fort Benning, Chattahoochee County, Georgia*. Prepared for the U.S. Army Corps of Engineers, Savannah, Georgia, by Alabama Museum of Natural History, Division of Archaeology, University of Alabama, Tuscaloosa.

Smith, Timothy J., II and Tom Des Jean

2007 The Geography of Illegal Distillery Sites in the Big South Fork National River and Recreation Area. Paper presented at the Annual Meeting on Current Research in Tennessee Archaeology, Nashville.

South Carolina Forestry Commission

2009 A Short History of Forest Industry in South Carolina. South Carolina Forestry Commission Website <[www.state.sc.us/forest/index.htm](http://www.state.sc.us/forest/index.htm)>. Viewed June 12, 2009.

Southerlin, Bobby G., Dawn Reid, James Hill, Eric Poplin, and Paul E. Brockington, Jr.

1995 *Archaeological Testing of Ten Sites, Fort Jackson Military Reservation, Richland County, Georgia*. Prepared for US Army Corps of Engineers, Norfolk, Virginia, by Jones Technologies, Inc., Washington, D.C., and Brockington and Associates, Inc., Atlanta, Georgia.

Spangler, F. Leroy

1921 How Pine Tar is Made in the South Atlantic States. In *Naval Stores: History, Production, Distribution, and Consumption, Compiled by Thomas Gamble*, pp. 41-42. Review Publishing & Printing Company, Savannah, Georgia.

Sproat, Ira E.

1916 *Refining and Utilization of Georgia Kaolins*. U.S. Department of the Interior, Bureau of Mines Bulletin 128. Washington, D.C.

Steen, Carl

1994 *An Archaeological Survey of Pottery Production Sites in the Old Edgefield District of South Carolina*. Diachronic Research Foundation, Columbia, South Carolina.

2006 *Testing Five Historic Sites Along Cabin Branch on Fort Bragg, 2004*. Submitted to US Army Construction Engineering Research Laboratory, Champaign, Illinois, by TRC Garrow Associates, Chapel Hill, North Carolina.

Steen, Carl and Chad Braley

1992 *A Cultural Resources Survey of Selected (FY92) Timber Harvesting Areas on Fort Jackson, Richland County, South Carolina*, Volume I: Report. Prepared for US Army Corps of Engineers, Savannah, Georgia, and The Directorate of Engineering and Housing, Fort Jackson, South Carolina by Gulf Engineers and Consultants, Baton Rouge, Louisiana, and Southeastern Archaeological Services, Inc., Athens, Georgia.

Stull, R.T.

1924 Distribution of Kaolin and Bauxite of the Coastal Plain of Georgia. *Journal of the American Ceramic Society* 7(7):513-522. Reprint by the Central of Georgia Railway, Savannah. Pamphlet on file at Hargrett Library, University of Georgia, Athens.

Thomson, M.T.

1953 The Grist Mill in Georgia. *Georgia Review* 7:332-346.

Tompkins, D.A.

1901 *Cotton and Cotton Oil*. Charlotte, North Carolina.

Townsend, Jan, John H. Sprinkle, Jr., and John Knoerl

- 1993 *National Register Bulletin 36: Guidelines for Evaluating and Registering Historical Archaeological Sites and Districts*. National Park Service, Washington, D.C.

Tyrrell, Ian R.

- 1982 Drink and Temperance in the Antebellum South: An Overview and Interpretation. *The Journal of Southern History* 48(4):485-510.

Van Tassel, Alfred J., and David W. Bluestone

- 1939 *Mechanization of the Brick Industry*. Works Progress Administration, National Research Project, Report No. M-2. Philadelphia, Pennsylvania.

Veatch, Otto

- 1909 *Second Report on the Clay Deposits of Georgia*. Geological Survey of Georgia Bulletin No. 18. Atlanta.

Veatch, Otto and Lloyd William Stephenson

- 1911 *Preliminary Report on the Geology of the Coastal Plain of Georgia*. Geological Survey of Georgia Bulletin No. 26. Atlanta.

Wakelyn, P.J., D.W. Thompson, B.M. Norman, C.B. Nevius, and D.S. Findley

- 2005 Why Cotton Ginning is Considered Agriculture. *Cotton Gin and Oil Mill Press* 106(8):5-9. Viewed on line at the National Cotton Council of America Website <[www.cotton.org/tech/safety/ginagclass.cfm](http://www.cotton.org/tech/safety/ginagclass.cfm)>. Accessed July 10, 2009.

Wayne, Lucy B.

- 1997 "Burning Brick and Making a Large Fortune at it Too": Landscape Archaeology and Lowcountry Brickmaking. In *Carolina's Historical Landscapes: Archaeological Perspectives*, edited by Linda F. Stine, Martha Zierden, Lesley M. Drucker, and Christopher Judge, pp. 97-111. The University of Tennessee Press, Knoxville.



Weldon , Bill

1990 The Brickmaker's Year. *The Colonial Williamsburg Historic Trades Annual* 2:1-40.

Wharton, Charles H.

1998 *The Natural Environments of Georgia* (Third Printing). Bulletin 114, Georgia Geologic Survey of the Environmental Protection Division of the Department of Natural Resources, Atlanta. (Originally published 1978.)

Whelan, James Patrick, Jr., and Charles E. Pearson

1988 *Archaeology of an Early Twentieth Century Black Community: The Good Land Cypress Sawmill Company, Terrebonne Parish, Louisiana*. Prepared for the State of Louisiana, Department of Transportation and Development, Baton Rouge, Louisiana by Coastal Environments, Inc., Baton Rouge, Louisiana.

Woodford, Chris

2008 Turbines. Explain That Stuff Website <<http://www.explainthatstuff.com/turbines.html>> Accessed June 16, 2009.

Zug, Charles G., III

1986 *Turners & Burners, The Folk Potters of North Carolina*. The University of North Carolina Press, Chapel Hill.