

**Context Study
of the
UNITED STATES
QUARTERMASTER GENERAL
STANDARDIZED PLANS
1866 - 1942**

**Prepared for
U.S. ARMY ENVIRONMENTAL CENTER
ENVIRONMENTAL COMPLIANCE DIVISION
Aberdeen Proving Ground
Maryland**

**by
U.S. ARMY CORPS OF ENGINEERS
SEATTLE DISTRICT
Technical Center of Expertise
for
Preservation of Structures and Buildings**

NOVEMBER 1997

DTIC QUALITY INSPECTED 1

DISTRIBUTION STATEMENT A

**Approved for public release;
Distribution Unlimited**

**Contributors:
Paul Chattey, Horace Foxall, Flossie McQueen,
Cynthia Nielsen, Mary Shipe, Terri Taylor, Jamie Tippet**

19980903 013

REPORT DOCUMENTATION PAGE

Form Approved
OMB No 0704-0188

Public reporting burden for this collection of information is estimated to average 1 hour per response, including the time for reviewing instructions, searching existing data sources, gathering and maintaining the data needed, and completing and reviewing the collection of information. Send comments regarding this burden estimate or any other aspect of this collection of information, including suggestions for reducing this burden, to Washington Headquarters Services, Directorate for Information Operations and Reports, 1215 Jefferson Davis Highway, Suite 1204, Arlington, VA 22202-4302, and to the Office of Management and Budget, Paperwork Reduction Project (0704-0188), Washington, DC 20503.

1. AGENCY USE ONLY (Leave blank)	2. REPORT DATE November 1997	3. REPORT TYPE AND DATES COVERED Final Report	
4. TITLE AND SUBTITLE "Context Study of the U.S. Quartermaster General Standardized Plans, 1866-1942"		5. FUNDING NUMBERS PR	
6. AUTHOR(S) U.S. Army Corps of Engineers Seattle District, Technical Center of Expertise for Preservation of Structures and Buildings		8. PERFORMING ORGANIZATION REPORT NUMBER	
7. PERFORMING ORGANIZATION NAME(S) AND ADDRESS(ES) U.S. Army Environmental Center Environmental Quality Division Aberdeen Proving Ground, MD		10. SPONSORING MONITORING AGENCY REPORT NUMBER	
9. SPONSORING MONITORING AGENCY NAME(S) AND ADDRESS(ES) U.S. Army Environmental Center Environmental Quality Division Aberdeen Proving Ground, MD		11. SUPPLEMENTARY NOTES	
12a. DISTRIBUTION AVAILABILITY STATEMENT Approved for public release; distribution is unlimited		12b. DISTRIBUTION CODE	
13. ABSTRACT (Maximum 200 words) <p>The Context Study of the United States Quartermaster General Standardized Plans 1866-1942 was developed to assist the Department of Defense in fulfilling its responsibilities as mandated under Army Regulation 200-4, the National Historic Preservation Act of 1966, as amended, the Secretary of Interior's Standards for Preservation Planning, and the guidelines of the National Register of Historic Places.</p> <p>The Quartermaster Corps constructed thousands of buildings, often using standardized plans, throughout the continental United States, Alaska, Hawaii and Panama. These buildings can be divided into types such as transportation-related buildings (aircraft hangars, gas stations, motor pools, and other buildings and structures). Multiple copies of the same buildings were built from nearly-identical plans at numerous installations, some differing only in external decorative features. The purpose of this study is to provide written historic context statements for the use of installation managers in inventorying and evaluating cultural resources.</p>			
14. SUBJECT TERMS Quartermaster General, standardized plans, buildings, structures			15. NUMBER OF PAGES 433
17. SECURITY CLASSIFICATION OF REPORT Unclassified			16. PRICE CODE
18. SECURITY CLASSIFICATION OF THIS PAGE Unclassified	19. SECURITY CLASSIFICATION OF ABSTRACT Unclassified	20. LIMITATION OF ABSTRACT SAR	

TABLE OF CONTENTS

HEADINGS	PAGE
A. CONCEPT	
1) INTRODUCTION	1
2) APPLICABILITY	2
3) TIME PERIOD	3
4) GEOGRAPHIC LIMITS	5
5) STANDARDIZED PLANS	5
A) INTRODUCTION	5
B) FIRST PERIOD: 1866 TO 1890	5
C) SECOND AND THIRD PERIODS	6
D) SHARED CHARACTERISTICS	10
E) THE 600, 700 AND 800 SERIES	11
F) "SEMI-MILITARY" BUILDINGS	12
G) CONCLUSION	14
6) DRAWINGS REPRESENTED IN THIS STUDY	14
B. METHODOLOGY AND GOALS	
1) OVERVIEW	18
2) NATIONAL HISTORIC PRESERVATION ACT OF 1966	18
3) STANDARDIZED PLANS AND HISTORIC SIGNIFICANCE	20
A) INTRODUCTION	20
B) PHYSICAL INTEGRITY	20
C) HISTORIC SIGNIFICANCE	21
D) WORLD WAR II TEMPORARY BUILDINGS	22
4) ORGANIZATION OF INFORMATION	22
5) USER'S MANUAL	24
A) A PRACTICAL GUIDE TO THIS STUDY	24
B) INTEGRITY, SIGNIFICANCE AND THE NATIONAL REGISTER OF HISTORIC PLACES	25
6) RESEARCH AT THE NATIONAL ARCHIVES	26
7) ASSISTANCE FROM INDIVIDUAL POSTS	27
8) TRANSFERRING FILES VIA THE INTERNET	27
C. QUARTERMASTER CORPS HISTORIC CONTEXT	
1) OVERVIEW OF THE QUARTERMASTER CORPS HISTORY	28
2) ARCHITECTURAL STYLES	31
3) FIRST PERIOD OF STANDARDIZATION, 1866-1890	33
A) ARMY POST DEVELOPMENT, LAYOUT AND STYLES	35
4) SECOND PERIOD OF STANDARDIZATION: 1890-1917	38
A) ARMY POST DEVELOPMENT, LAYOUT AND STYLES	39

HEADINGS	PAGE
5) THIRD PERIOD OF STANDARDIZATION: 1917-1941	40
A) WORLD WAR I	40
B) POST WORLD WAR I	47
C) ARMY AIR CORPS	48
D) THE CONSTRUCTION PROGRAM	50
E) ARMY POST DEVELOPMENT, LAYOUT & STYLES	54
F) LANDSCAPE PLANTINGS	57
G) SITE PLANNING	58
H) THE TRANSITION	62
D. CONCLUSION	64
E. BUILDING TYPES	
INTRODUCTION	67
1. ADMINISTRATION	
A) FIRE STATIONS	73
B) GUARD HOUSES, GATEHOUSES, SENTRY BOXES	76
C) HEADQUARTERS BUILDINGS, ADMINISTRATION BUILDINGS & OFFICE BUILDINGS	82
D) POST OFFICES	93
2. COMMUNICATIONS	
A) RADIO BUILDINGS	97
B) TELEGRAPH & TELEPHONE BUILDINGS	101
3. EDUCATION	
A) CLASSROOM BUILDINGS	104
B) DRILL & RIDING HALLS	110
4. HEALTH CARE	
A) DISPENSARY, INFIRMARY	113
B) HOSPITALS	120
5. INDUSTRIAL	
A) MAINTENANCE & REPAIR SHOPS	142
B) MANUFACTURING COMPLEXES	150
C) SERVICE FACILITIES	
1) BAKERIES	155
2) LAUNDRIES	159
D) STORAGE	
1) GENERAL STORAGE	163
2) ORDNANCE	178
6. INFRASTRUCTURE	
A) POWER PLANTS/ELECTRICAL SYSTEMS	185
B) WATER AND SEWAGE SYSTEMS/WASTE INCINERATORS	188
7. RECREATIONAL/SOCIAL/CULTURAL/RELIGION	
A) ASSEMBLY HALLS	192
B) ATHLETIC FACILITIES	196

HEADINGS	PAGE
c) CHAPELS	204
d) CLUBS - OFFICER & NON-COMMISSIONED OFFICER (NCO)	208
e) ELEMENTARY SCHOOLS	211
f) EXCHANGE	216
g) THEATERS	220
8. RESEARCH & DEVELOPMENT	
a) LABORATORIES/RESEARCH & TESTING FACILITIES	223
9. RESIDENTIAL	
a) INSTITUTIONAL HOUSING	
1) BACHELOR OFFICERS QUARTERS/NURSES QUARTERS	227
2) BARRACKS/DORMITORIES/CIVILIAN HOUSING	236
b) INSTITUTIONAL HOUSING SUPPORT BUILDINGS	
1) DETACHED LAVATORIES/BATHHOUSES	254
2) MESS HALLS	261
c) FAMILY HOUSING	
1) NON-COMMISSIONED OFFICERS (NCO) HOUSING	269
2) OFFICER HOUSING	293
d) FAMILY HOUSING SUPPORT BUILDINGS	
1) GARAGES	321
10. TRANSPORTATION	
a) AIR-RELATED	
1) AIRPLANE HANGARS	326
b) ANIMAL-RELATED	
1) STABLES & STABLE COMPLEXES	336
c) VEHICLE-RELATED	
1) GAS STATIONS	351
2) MOTOR POOLS	355
d) RAILROAD-RELATED	
1) TRESTLES, RAIL LINES AND LAYOUTS	359
F. DATABASE	
1. INTRODUCTION	368
2. SORTED BY TYPE	370
3. SORTED BY STANDARDIZED BUILDING PLAN NUMBER	381
4. SORTED BY INSTALLATION	392
5. SORTED BY BUILDING NAME	402
6. SORTED BY DATE	412
G. BIBLIOGRAPHY	423
1) BOOKS AND ARTICLES	423
2) RESOURCES IN THE NATIONAL ARCHIVES	427
a) CARTOGRAPHIC & ARCHITECTURAL BRANCH	430
b) STILL PHOTOGRAPH DIVISION	430
3) NATIONAL ARCHIVES, ALASKA REGION	431
4) ARCHIVES AND UNPUBLISHED MATERIAL	432

LIST OF ILLUSTRATIONS

FIGURE	PAGE
1. BUILDING DETAILS FOR NORTHERN & SOUTHERN CONSTRUCTION	8
2. ARCTIC ENTRY AT LADD FIELD, NOW FORT WAINWRIGHT	7
3. BARRACKS BUILT FROM 800 SERIES IN CONCRETE BLOCKS	9
4. STANDARDIZED PLAN FOR SHOP	10
5. TYPICAL BARRACKS AT CAMP DEVENS, MA IN 1917	10
6. PLAN FOR YWCA BUILDING	14
7. EXAMPLE OF WAR DEPARTMENT FORM 117 INVENTORY FORM	16
8. EXAMPLE OF ARMY FORM 2877 REAL PROPERTY RECORD	17
9. REFLECTIONS FROM PROTECTIVE ENVELOPES	26
10. ADMINISTRATION BUILDING, DEPARTMENT OF THE DAKOTA	35
11. FORT LARAMIE, 1842	36
12. LAYOUT OF FORT RILEY, KANSAS	37
13. PROPOSED PLAN FOR TYPICAL GARRISON, 1860	38
14. ARMY WAR COLLEGE AND ENGINEERS POST	40
15. STANDARDIZED PLANS FOR CANTONMENT GROUNDS	44
16. STANDARDIZED PLANS FOR TYPICAL REGIMENT OF INFANTRY, BRIGADE HEADQUARTERS, AND MACHINE GUN BATTALION	45
17. STANDARDIZED PLANS FOR QUARANTINE CAMP FOR 1,000 MEN	46
18. BROADMOOR NEIGHBORHOOD AT FORT LEWIS, WASHINGTON	56
19. TYPICAL LANDSCAPE PLANTING PLANS: COMPANY OFFICERS' QUARTERS AND DOUBLE N.C.O. QUARTERS	59
20. TYPICAL LANDSCAPE PLANTING PLANS: HEADQUARTERS ADMINISTRATION BUILDING, BACHELOR OFFICERS' QUARTERS AND BARRACKS BUILDINGS	60
21. TYPICAL LANDSCAPE PLANTING PLANS: THEATER, CHAPEL AND HOSPITAL AREA	61
22. EVOLUTION OF SITE PLANNING	62

LIST OF TABLES

TABLE	PAGE
1. REPRESENTATIVE EXAMPLES OF BUILDINGS FROM THREE PERIODS	4
2. PARTIAL LIST OF 700 SERIES BUILDINGS	11
3. SEMI-MILITARY BUILDINGS IN WORLD WAR I CANTONMENTS	13
4. THE NATIONAL REGISTER CRITERIA	19
5. EXAMPLES OF SPECIFIC HISTORIC CONTEXTS	19
6. ASPECTS OF HISTORIC INTEGRITY	20
7. BUILDING TYPES AND DESCRIPTIONS	22
8. LIST OF TABLE HEADINGS	23
9. SAMPLE TABLE SORTED BY <i>TYPE</i>	24
10. SAMPLE TABLE SORTED BY <i>PLAN NUMBER</i>	24
11. HEADINGS USED IN TYPE CONTEXT STATEMENTS	25
12. QMC DEPOTS IN 1940	30
13. SUMMARY OF ARCHITECTURAL STYLES AND PERIODS USED BY QMC	32
14. CHRONOLOGY OF ARCHITECTURAL STYLES	33
15. NATIONAL ARMY CANTONMENTS AND NATIONAL GUARD CAMPS, 1917	42
16. CANTONMENT GROUNDS: PARTIAL LIST OF LAYOUT PLANS, 1918	47
17. MAJOR CONSTRUCTION AT SELECTED AIR CORPS BASES	49
18. INSTALLATIONS RECEIVING MAJOR CONSTRUCTION PROJECTS UNDER THE NATIONAL INDUSTRIAL RECOVERY ACT	51
19. SUMMARY OF QUARTERMASTER PROJECTS COMPLETED ON DECEMBER 4, 1941	65

STANDARDIZED PLANS STUDY: QUARTERMASTER CORPS 1866-1942

A. CONCEPT:

1) INTRODUCTION

The *Study of the United States Quartermaster General Standardized Plans 1866-1942* was developed to assist the Department of Defense in fulfilling its responsibilities as mandated under *Cultural Resources Management* (Army Regulations AR 200-4); the National Historic Preservation Act of 1966, as amended; the Secretary of the Interior's *Standards for Preservation Planning*; and the guidelines of the National Register of Historic Places (particularly National Register Bulletins 16A and 16B, *How to Complete the National Register Registration Forms*).

The Quartermaster Corps constructed thousands of buildings, often using standardized plans, throughout the continental United States, Alaska, Hawaii and Panama. These buildings can be divided into types, for example: transportation-related buildings include aircraft hangars, stables and stable complexes, gas stations, motor pools and railroad buildings and structures. Multiple copies of the same buildings were built from nearly-identical plans at numerous installations, some differing only in external decorative features. The purpose of this study is to provide written historic context statements for the use of installation managers called on to inventory and evaluate cultural resources.

This study is a subset of a larger work encompassing the building types, architectural history and general historic framework of the Army, Navy, Marine Corps, and Air Force.¹ Researchers interested in other branches of the Armed Forces will find a vast amount of useful material there. The *Study of the United States Quartermaster General Standardized Plans, 1866-1942* has an exclusive focus on Army buildings and structures and is organized in six parts. The first two sections are designed to be helpful to persons unfamiliar with standardized plans. **Concept**, the first section, includes a definition of the limits of this study in terms of time, geography, standardized plans themselves and, finally, the scope of the resource. The second section, **Methodology and Goals**, provides an introduction to evaluating buildings and structures to determine if they are historic. A user's manual to the resources in this study is included here, as is a brief summation of the research completed for this project.

The third section, **The Quartermaster Corps: An Historic Framework**, includes a discussion and analysis of the following:

Accomplishments of the Quartermaster Corps
Architectural styles and landscape architecture used by the Quartermaster Corps

¹ R. Christopher Goodwin and Associates, *National Historic Context for Department of Defense Installations, 1790-1940: Volumes I-IV* (U.S. Army Corps of Engineers, Baltimore District, August 1995.)

Layouts and construction of Army and Army Air Corps post
Major construction programs
Conclusions

The fourth section, **Building Types**, contains information about individual building types, photographs and standardized plans of representative examples. In this section, material dealing with the Army was taken from the larger work, *National Historic Context for Department of Defense Installations, 1790-1940: Volume II*. Within each building type, the following information is discussed:

Description of the type's size, number of stories, identifying features, Etc.
Evolution of the type in support of the Army mission
Association with historic themes of state and national significance
Issues regarding material integrity and character-defining features

Sorted Tables, the fifth section, was derived from a database containing the standardized plans referenced in this study comprise the third section. These tables provide listings of buildings by:

Type
Plan number
Building name
Installation
Date of plan approval.

Finally, the sixth section includes references in a **Bibliography**.

It is suggested that this study be used in conjunction with *National Historic Context for Department of Defense Installations, 1790-1940: Volumes I - IV* (R. Christopher Goodwin and Associates, Inc. for U.S. Army Corps of Engineers, Baltimore District, August 1995).

2) APPLICABILITY

Army Regulation 200-4 prescribes Army policies, procedures and responsibilities for meeting cultural resources compliance and management requirements. These policies are designed "to ensure that Army installations make informed decisions regarding the cultural resources under their control in compliance with public laws, in support of the military mission, and consistent with sound principles of cultural resources management."²

This regulation applies to the Active Army, the Army National Guard (ARNG), the US Army Reserve and to all installations and activities under control of the Department of the Army by ownership, lease, license, public land withdrawal, or any similar instrument. Specifically it applies to:

² Department of the Army *Army Regulation 200-4* (Washington: Director of Environmental Programs, Headquarters, Department of the Army, 31 July 1996), 1-1.

- a. Army installations and activities;
- b. Army National Guard federal installations, activities, and sites supported with federally appropriated funds or subject to federal approval;
- c. Installations and activities, or portions thereof, that are in full-time or intermittent use by the US Army Reserve or Reserve Officers Training Corps;
- d. Real property of other Federal, State, or Reserve Office Training Corps under license, permit, lease, or other land and/or facility use agreement;
- e. Military functions of the US Army Corps of Engineers (USACE);
- f. Tenants, such as other federal agencies, contractor activities, lessees, and all others performing activities in direct support of the Army located on real property under Department of the Army jurisdiction,
- g. Contracts at government-owned, contractor-operated facilities which will reference this regulation and/or will designate by specific citation applicable provisions of this regulation.

3) TIME PERIOD: 1866-1942:

This study spans from 1866 to 1942, which is the period when the Quartermaster Corps was directly responsible for Army construction³. Buildings remaining from the early portions of this period are associated with broad patterns in the early development of the nation and with specific historic themes. For example, during the westward expansion following the Civil War, the Army surveyed many of the nation's railroad routes. After the rail lines were built, Army forts were established along railroad corridors at major transportation centers. These forts consisted of either temporary or permanent buildings, some of which remain today as early representatives of this historic period. Another example of an association with an historic themes includes many of the buildings built in the second and third decade of the twentieth century. These structures include radio buildings, classroom buildings, repair shops, ordnance storage, assembly halls, chapels, clubs, post exchanges and mess halls. As a whole, they are representative examples of a concentrated national effort to mobilize a large army for international warfare.

Three periods of standardized building plans correspond to Quartermaster Corps construction activity: 1860s to 1890, 1890 to 1917, and 1917 to 1942. In the first period (1866-1890) the Quartermaster Corps, the Corps of Engineers and others built Army housing and other buildings. Standardized building plans started to appear in this period, when Army designers gave their attention to standardization.

The second period (1890 to 1917) is characterized by a long series of building types developed by the Quartermaster Corps in Washington, DC. These included officer and NCO housing, barracks, headquarters, gymnasiums, storehouses, post exchanges and other building types. Building materials were varied also and included wood, brick, stone, concrete, clay tile, and so on. For family housing alone, there were "82 different plans with anywhere from 1 to 15

³ In 1942, the Quartermaster Corps shared responsibility for the Army's construction with the Corps of Engineers.

variations.”⁴ This was an enormously productive period. The War Department built thirty-two camps, called cantonments, to train 1,280,000 men. Sixteen of these cantonments were built for the National Guard, whose men were already trained and could live in tents and a minimum number of wood buildings. Sixteen more were built on a huge scale for the Regular Army.

The third period (1917 to 1942) began after the lean post-World War I years, when Congress tightened the purse strings and the Army was severely reduced in size. By the early 1920s, second period buildings had deteriorated dangerously due to lack of funds for maintenance. Soldiers were often sheltered in tents or in buildings that were cold in winter; officers worried about the dangers of fire. An ambitious nation-wide housing program was started in 1926 when Congress enacted Public Law No. 45, authorizing the Secretary of War to sell off forty-three posts and use the profits for a Military Post Construction Fund to build new structures at the remaining posts. This move came at a time when the Army recognized the need for a centralized organization and decided to consolidate its forces. The Defense Act of 1920 established nine corps areas in the continental United States, “with each Corps to contain one active Army division, plus one Reserve and two National Guard divisions.”⁵

Initial funding was only sufficient to improve enlisted barracks and hospitals, so the Army concentrated on posts with the greatest need. Increased appropriations in the following years allowed Army planners to address landscape issues for entire Army posts. During this time, post layouts included design elements from the new field of town and city planning. Attention was also given to comfortable housing that provided a healthy environment for officers and troops. In 1931 costs for the Army’s housing construction program were over \$49 million.⁶ By 1933 the total figure had risen to \$145 million. These funds were used at sixty-four installations and paid for 1,091 sets of quarters that were completed in January 1940.

By the start of World War II, the Quartermaster Corps was charged with construction of mobilization camps; Army Air Corps bases; ordnance works assembly plants for tanks, aircraft and munitions; and hospitals, to name only a few kinds of projects. These projects extended from Alaska to Panama and through the Pacific Islands. They served the Regular Army and National Guard as well as the needs of armies in countries that became our allies. The third period ends with the transfer of construction activities to the Army Corps of Engineers on December 1, 1941 and the transition period into 1942, when both organizations had responsibility for the Army’s construction.

TABLE 1--REPRESENTATIVE EXAMPLES OF BUILDINGS FROM THREE PERIODS

Period	Building	Date	Installation
1866-1890	Double Set N.C.S.O. Quarters	1885	F. E. Warren Air Force Base
1890-1917	Officer’s Club	1916	Fort Chaffee
1917-1941	Gymnasium	1940	Fort D. A. Russell

⁴ Bethanie C. Grashof *A Study of United States Army Family Housing Standardized Plans, 1866-1940* (Atlanta, Georgia: Georgia Institute of Technology, 1986), 9.

⁵ Goodwin, R. Christopher and Associates, *National Historic Context for Department of Defense Installations, 1790-1940: Volume I*, (U.S. Army Corps of Engineers, Baltimore District, August 1995), 76.

⁶ This includes \$16 million under contract and \$3 million under advertisement.

4) GEOGRAPHIC LIMITS

This study covers the continental United States and has limited applications to sites in Alaska and Hawaii where Quartermaster designs were erected during World War II. The Quartermaster organization also erected buildings in the Caribbean, South and Central America, Europe and Asia but buildings in these areas are not covered in this study.

5) STANDARDIZED PLANS

a. Introduction

A standardized architectural plan is defined, for this study, as having been used to construct a building or structure at more than one Army post, either as part of a construction program or because plans were exchanged between posts. This study of standardized plans does not include an examination of specifications used on standardized plans. Specifications contain precise and detailed lists of written information which can specify the materials, process, order, or level of workmanship to be achieved. While specifications are interesting for what they can tell us about the materials described, level of technology, or even the design intent of the people who wrote them, specifications properly belong with the drawn portion of plans. Like drawings, specifications are building-focused.

The Army's standardized plans include a vast group of building types. While "standardized" indicates a similarity and uniformity of materials, massing, size and ornamentation, there are slight variations to be found within groups of Army standardized plans. There are a number of reasons for this variety, ranging from programmatic to aesthetic influences.

b. First Period. 1866 to 1890

From 1866 to 1890, the Army's mission was focused on operations at posts on the western frontier, coastal defense posts and some special purpose facilities. After the Civil War, as the frontier was opened to European-American settlement and Native Americans were confined to reservations, many western posts either became permanent garrisons or disappeared. Coastal defense installations in masonry fortifications with smooth-bore artillery were rendered obsolete by rifled guns aboard ships that could demolish masonry walls. A few batteries of heavy artillery, isolated for protection, were built in casemates at strategic locations. Coastal defense troops lived in damp conditions within the casemates. Special purpose facilities included arsenals, armories, Quartermaster depots and special Army schools like the Army Artillery School at Fort Monroe (revived in 1868 after being discontinued in 1860), the Signal School at Ft. Whipple, Virginia (1869), and the Cavalry and Light Artillery School (established at Ft. Riley in 1892). During this time, living conditions were uniformly bad as noted in 1875 in the Surgeon General's *Report on the Hygiene of the United States Army, with Descriptions of Military Posts*. The report noted that "crowded living conditions, contaminated water supplies and faulty

construction of quarters contributed to diseases among soldiers.”⁷

In 1882, General William T. Sherman, Commanding General of the Army, offered a plan to Congress that would consolidate the Army’s small garrisons into larger ones by keeping selected posts and building permanent buildings there, keeping a few posts for 10 to 15 years, and abandoning others. Enthusiastically supported by the War Department and Sherman’s generals, little funding was available either for permanent buildings or to move troops. Nine years later, twenty-eight (about one-fourth of the total number of western posts) had been abandoned and ten or twelve more were ready as soon as shelter could be found for the troops. Garrison strengths in 1894 still “ranged from 60 to 750 soldiers.”⁸

The Quartermaster Department had been developing and using a few standardized plans since the 1860s. It was not, however, until the 1880s that the War Department began construction of permanent facilities with water and utilities. By 1893, the Secretary of War noted that in “all posts which give the promise of permanency it has been the aim of the Department to construct buildings of brick, stone, or other enduring material and of solid workmanship...”⁹ During the 1890s, the Quartermaster developed hundreds of standardized plans for many building types, including “officer and NCO quarters, barracks, stables, telegraph offices, administration buildings, and riding halls.”¹⁰

c. Second and Third Periods (1890 to 1917 & 1917 to 1942)

Standardized plans have been used to construct buildings the Army considered both permanent and temporary. During World War II, the Army used more than 30,000 temporary buildings to shelter, train, and feed its troops. The majority of these buildings were put up with an intended design life of five to twenty years. In 1985, an Army inventory indicated that 24,000 of these “temporary” buildings were “still standing and that a large but undetermined number were still in use.”¹¹ Many of these buildings are temporary in name only because of long periods of lean funding when the Army had neither the money to build replacements nor to remove them. During the period leading up to and including World War II, Army standardized plans were developed for a very wide range of buildings and structures; these include headquarters buildings, barracks, electrical vaults, prisoner of war camps, railroad trestles and munitions storage. Even within a single building type, the Army’s standardized plans can exhibit some variety due to regional influences. This application of regional architectural styles also allowed for the use of local materials and resulted in a lower per-unit cost. During this period, the Army

⁷ Goodwin, R. Christopher and Associates, *National Historic Context for Department of Defense Installations, 1790-1940: Volume I*, (U.S. Army Corps of Engineers, Baltimore District, August 1995), 25.

⁸ Goodwin, R. Christopher and Associates, *National Historic Context for Department of Defense Installations, 1790-1940: Volume I*, (U.S. Army Corps of Engineers, Baltimore District, August 1995), 26.

⁹ War Department, *Annual Report* (1893), 9.

¹⁰ Goodwin, R. Christopher and Associates, *National Historic Context for Department of Defense Installations, 1790-1940: Volume I*, (U.S. Army Corps of Engineers, Baltimore District, August 1995), 47.

¹¹ Arlene R. Kriv, Editor, *World War II and the U.S. Army Mobilization Program: A History of 700 and 800 Series Cantonment Construction*, (Washington: Historic American Building Survey/Historic American Engineering Record (HABS/HAER) National Park Service for Department of Defense, 1993), 3.

built entire posts at which all buildings on post “should have a military character, but it should be the character of its *local* and its natural traditions.”¹² Buildings also conformed to what planners perceived as a region’s prevalent architectural style. Examination of an Early Federal style barracks and a Spanish Mission style barracks constructed from the same series of plans, reveals that except for exterior ornamentation and roof styles, the interior layout is very similar.

Climate also had an influence on the appearance of buildings built from standardized plans. Army barracks constructed from 1918 Quartermaster Corps standardized plans in the nation’s southern states varied from those built for the colder, northern climate. (See Figure 1.) Practically identical, the interior walls and ceilings of those buildings in the northern states were finished with a single layer of wall board (either 3/16” fiber or 3/8” gypsum). Soldiers living in barracks in southern areas had to be content with interior wall surfaces showing open studs. In more extreme conditions, standardized buildings at Ladd Field, near Fairbanks, Alaska, received Arctic entries (cold weather vestibules) and some were built several feet above ground to avoid melting “permanently” frozen ground.¹³ (See Figure 2.)



Figure 2. Arctic entry added to Nurses Quarters at Ladd Field (now Fort Wainwright) near Fairbanks, Alaska.

¹² Grashof, Bethanie C., *A Study of United States Army Family Housing Standardized Plans*, Volume I, (Atlanta: Georgia Institute of Technology, College of Architecture, 1986), 49.

¹³ They also received extra insulation, improved attic ventilation and strengthened roof trusses. Utilities at Ladd were placed in an underground “utilidor” for ease of access during minus twenty and even minus forty degree winters.

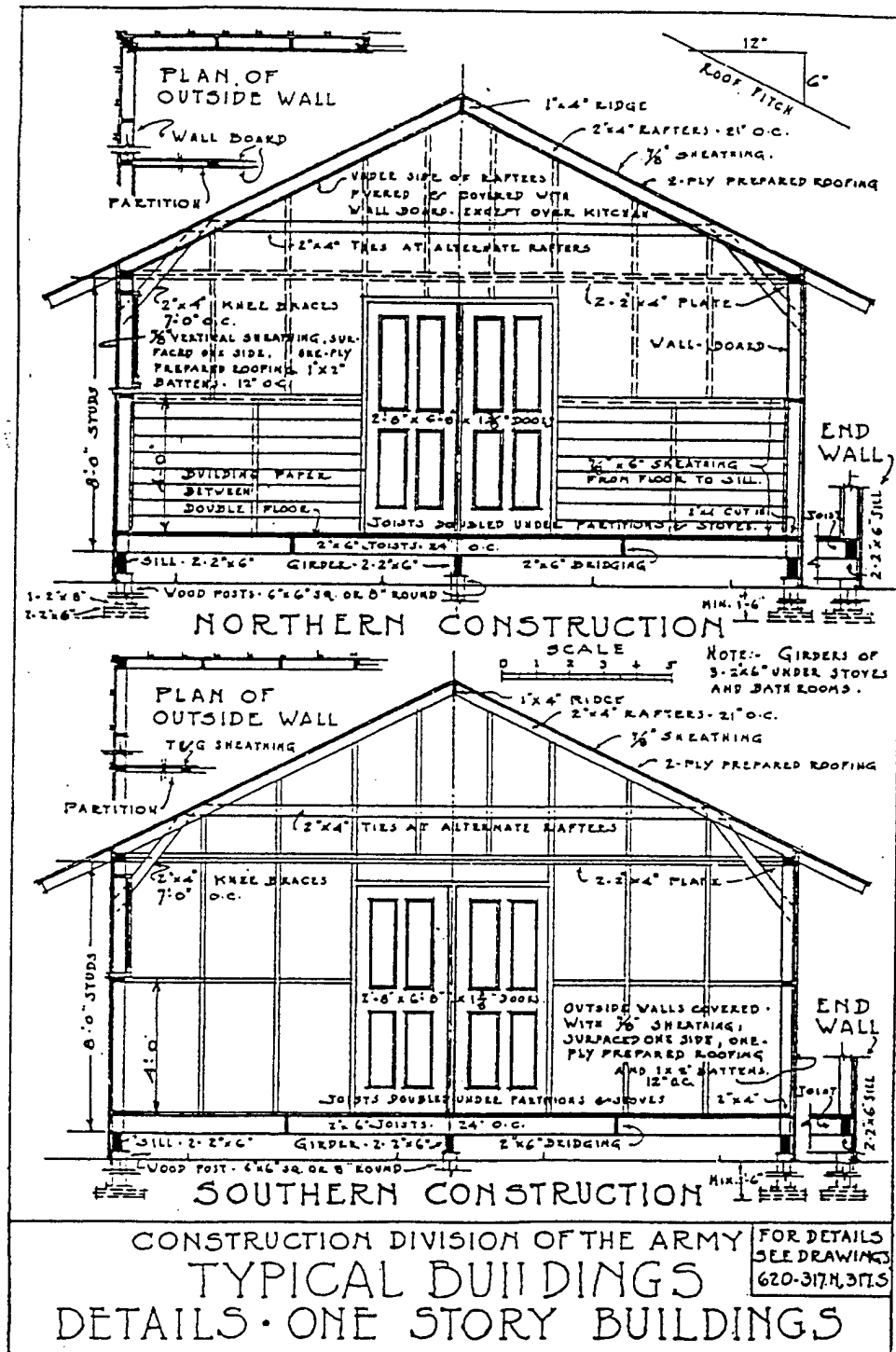

Figure 1. Typical building details for standardized buildings to be built in either northern or southern areas. (Construction Division, *Manual of the Construction Division of the Army, Section C, Engineering Division* [Washington: Consolidated Supply Co. Printers, 1919, plate 46])

Standardized plans were also influenced by a quest to obtain the most efficient building at a reasonable cost. For example, during World War II, experiments were conducted in construction

of standardized barracks built of masonry, steel and hollow tile.¹⁴ Eventually, wood was chosen as the most cost-effective and easily obtained material. Yet another series of barracks, generally built of wood, were occasionally built of concrete masonry blocks, as at Bolling AFB (See Figure 3.).

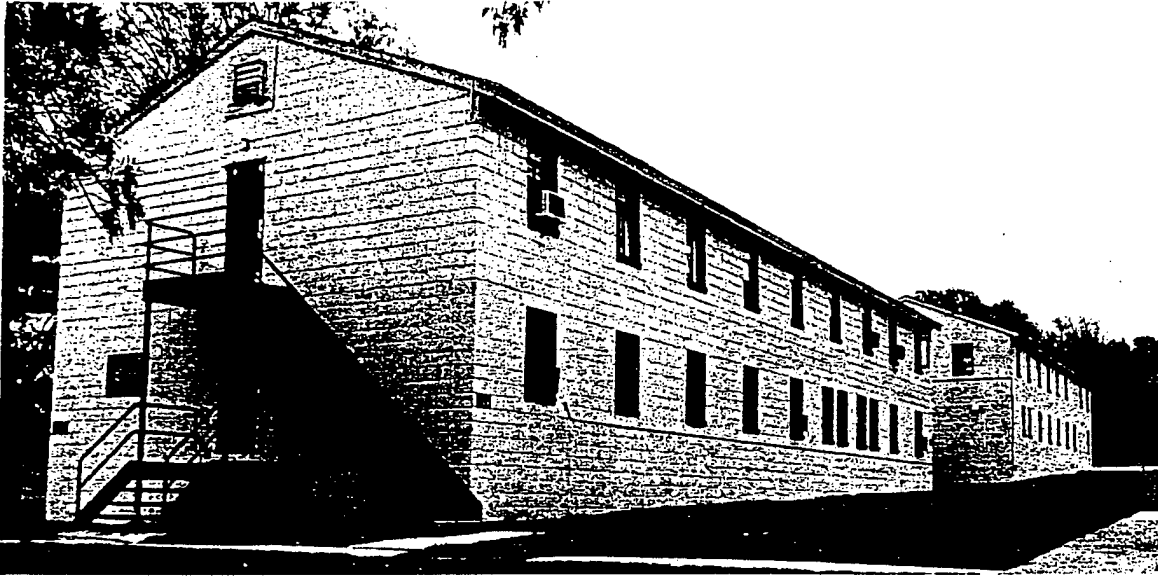

Figure 3. Building 424, barracks built from 800 series standardized plans at Bolling Field, now Bolling Air Force Base, District of Columbia. Note that the walls are laid up in concrete masonry blocks instead of being wood-framed. (US Army Corps of Engineers, Seattle District, 1997)

Another influence on standardized plans was the Army's changing role. Early Quartermaster Corps standardized plans included shops with work spaces for a blacksmith, saddler, and carpenter. (See Figure 4.) By World War II, as the Army prepared to fight a technological war, standardized plans had been developed with much cleaner work spaces for avionics repair. Also, armored tanks and large trucks required new standardized plans to build significantly larger shops and garages than were needed when the Army relied upon mules and horses. In 1942, standardized plans were even developed for runways. Runways at Army Air Corps fields had initially designed for light aircraft but many runway surfaces failed under the loads of repeated landings and take-offs of hundreds of small training aircraft, much less those of new medium and heavy bombers. Developed by the Corps of Engineers, a method to compact soils and build a slight amount of "flex" into the paving had its genesis in the highways designed by the California Highway Department. The new flexible runway surfaces were sufficiently strong to support thousands of landings and resulted in "three new chapters in the *Engineering Manual* and a comprehensive handbook for Aviation Engineer Battalions."¹⁵

¹⁴ Lenore Fine and Jesse A. Remington *The Corps of Engineers: Construction in the United States* (Washington: The Technical Services, Office of the Chief of Military History, United States Army, 1972) 344

¹⁵ Fine & Remington, 632.

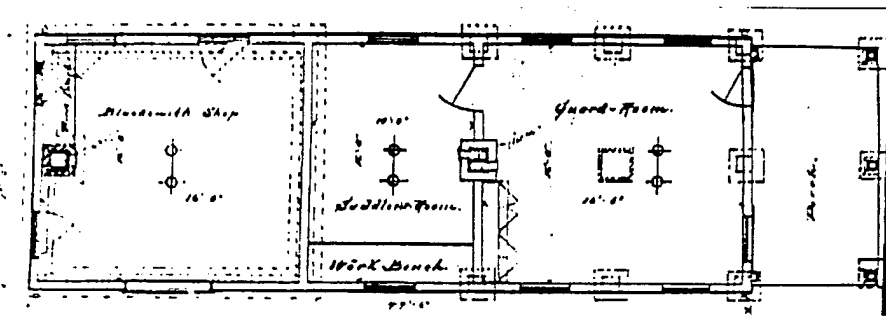

Figure 4. Standardized Army plan for a blacksmith shop, saddler room, guard house, no date. (National Archives)

d. Shared Characteristics

Aesthetic, practical and mission-oriented considerations aside, the Army usually repeated the same design over and over at individual posts until there were enough repair shops, chapels, garages, barracks, Etc. to shelter and train troops. While standardized plans exhibit slight variations and evidence a distinct evolution of role, materials and style, standardized plans also share a great deal of common ground. Standardized plans, particularly those from the second and third periods, were often the product of a careful analysis of cost, efficiency and ease of construction. Utilitarian in character, their architecture is generally restrained and plain. Even

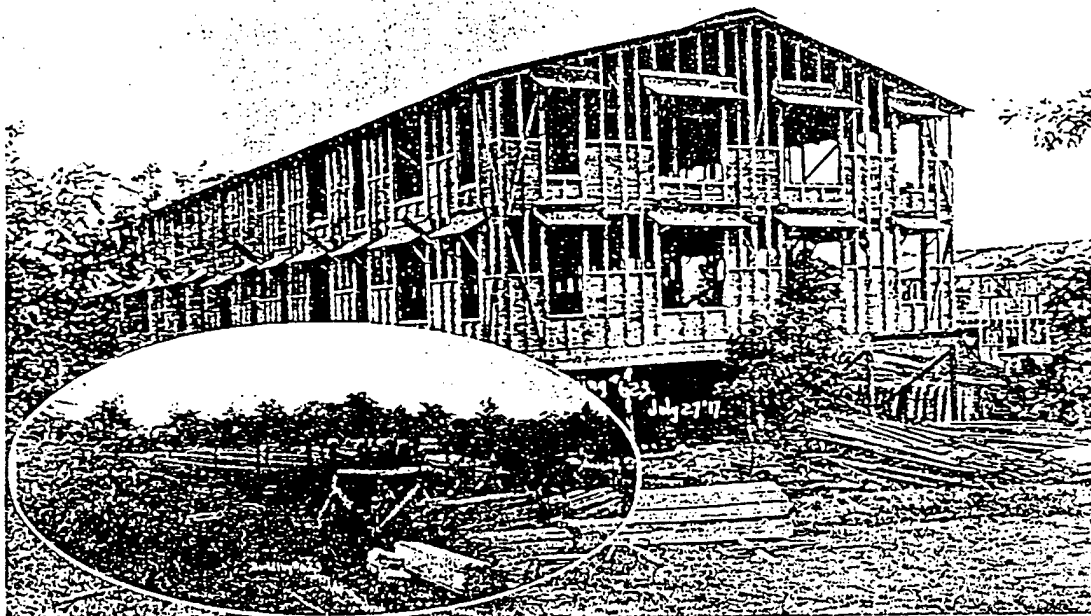

Figure 5. A typical barracks at Camp Devens at Ayer, Massachusetts. The insert (July 20th 1917) shows pre-cut lumber. Seven days later, in the larger view, the building is framed and nearly enclosed. (Peter F. O'Shea, "The Human Side of Cantonment Building", *American Builder*, October 1917, Volume 24, No. 1, 41)

the Army's Spanish Mission style buildings have a reserved character and are devoid of gaudy ornamentation. An example of efficiency of cost was achieved through the purchase of materials in bulk, as in the construction of Camp Devens in Ayer, Massachusetts in 1917 where

26,000,000 board feet of southern pine was purchased.¹⁶ See **Figure 5**.

Buildings erected from standardized plans may also have in common the prefabrication of building elements like siding, trusses, windows, doors, and so on. Assembly-line precision in erection is another characteristic of standardized plans. Returning to Camp Devens in Massachusetts, the rapid construction of 1,600 buildings was accomplished by extremely efficient planning and organized teams. Layout teams marked the location of buildings and roads, these were followed by brushing teams to remove undergrowth. Behind them came road crews building temporary roads for the trucks to deliver materials to the job sites so the work crews could start construction. Meanwhile, other crews were laying out mains and sewer lines, digging ditches, installing pipe and covering it over--practically as soon as the pipe was laid. Tools were used in quantity, with a blacksmith shop attached to a central tool house and equipped with "forges, grindstones, drills and iron cutters" to sharpen and fix broken tools. Kitchens served 18,000 meals a day in three open air restaurants and at seven booths in remote sites.

e. The 600, 700 and 800 Series Standardized Plans

War II temporary buildings were constructed from a numbered series of plans, referred to as the 700 series. Some feeling for scale is perceived with the understanding that the 700 series comprises drawings and specifications for over 300 distinct building types, with variations within each type. Individual plans for buildings within this series are numbered with a 700- prefix, as seen in **Table 2**, a partial list of 700 series building plans. This numbering system also extended to many drawings needed for each building that showed construction details. For example, the detail drawings required for construction of a standardized Motor Repair Shop are listed under the heading for that building, also in **Table 2**.

TABLE 2. PARTIAL LIST OF 700-SERIES BUILDINGS, SHOWING VARIETY OF BUILDING TYPES AND DETAIL DRAWINGS

Plan Number	Building Type
700-301	Quarters, Major General, Brigadier, Regimental Commander
700-310	Recreation Building
700-314	Shop -- Motor Repair
700-314.1	<i>Wheel Aligning Bay</i>
700-230	<i>Typical Details of Doors & Windows</i>
700-231	<i>Exterior & Interior Miscellaneous Details</i>
700-232.1	<i>Exterior & Interior Miscellaneous Details</i>
700-233	<i>Exterior & Interior Miscellaneous Details</i>
700-234	<i>Details of Smoke Pipes</i>
700-239	<i>Heating Details</i>
700-243	<i>Electrical Details</i>
700-1162	<i>Miscellaneous Details</i>
700-372	Sheds – Motor Vehicles
700-462	Ward – Standard

¹⁶ Peter F. O'Shea, "The Human Side of Cantonment Building", *American Builder*, October 1917, Volume 24, No. 1, 148.

700-1116	Mess Hall for 118 & 250 Men
700-1116.1	Mess Hall for 170 Men
700-1117	Mess Hall for 250 Men
700-1165	Barracks for 65 Men
700-1165M	Barracks for 63 & 74 Men
700-1168	Barracks for 45 & 63 Men

The 700 series gave way to the 800 series, which has similarities to the 700 series. The 800 series is characterized by slight structural improvements, the removal of superfluous features, and the enlargement of several building types, such as troop barracks.

Prior to the 700 series, there was also a 600 series which was developed and used by the Quartermaster Corps in World War I. The 700 series has a chronological but not an evolutionary relationship to the 600 series as buildings from the two series are dissimilar. The 600 series offered “standard drawings and specifications ... for camp plans, hospital and miscellaneous buildings, plumbing, sewers, sewage disposal plants, heating, water supply, electric lighting, refrigeration, roads, railroads, terminals, etc.”¹⁷ Quartermaster buildings dating from World War I and built using the 600 series are somewhat difficult to find. For example, only 14 of 450 buildings in the historic district at Fort Lewis, Washington survive that were built using the 600 series.

As the Army’s mission changed, some buildings were adapted for reuse but some new construction was required to fit the new mission. This evolution extended to practically all building types covered in this study. Stables were renovated to become storage buildings, and ordnance repair shops were converted for use as offices and radio repair facilities. New buildings were required for special uses and to shelter new units created in response to the increasingly technical nature of warfare. Vehicle repair shops were built to accommodate large trucks and tanks of progressively large size and new buildings were designed to calibrate bomb sights, perform plastic surgery, and train men for chemical warfare. The design of residential buildings underwent tremendous change, moving from wood buildings with no plumbing to masonry barracks with all utilities.

f. “Semi-Military Buildings

A unique group of World War I buildings, termed “semi-military”, was also constructed from standardized plans at Army posts. Several types of community and service buildings are identified below but are not analyzed in this study as they were designed and paid for by private funds--although often built by troop labor. (See **Table 3**.)

Community and service buildings played an important part in providing recreation and a variety of comforts within the World War I cantonments. The design and construction of these buildings was the responsibility of the War Department’s Commission on Training Camp Activities. Located within the War Department but staffed with civilians, this organization was responsible

¹⁷ Quartermaster Corps, Engineering Division, *Manual of the Construction Division of the Army, Section C* (Washington: Consolidated Supply Co. for U.S. Army, 1919) 2.

for administering the joint effort of social service groups in behalf of troops and officers by supplying "our young men everywhere with the normalities of life."¹⁸ A special grant of \$320,000 to accomplish this goal was donated by the Carnegie Corporation, supplemented with other funds from organizations such as the Knights of Columbus, the Jewish Welfare Board, the

TABLE 3. SEMI-MILITARY BUILDINGS LOCATED IN ARMY WWI CANTONMENTS

Building Type	Designer	Description
Liberty Theater	Commission on Training Camp Activities	Two types. Each of 16 National Army camps received one theater. Wood framed with capacity for 3,000, stage, orchestra pit, dressing rooms. Nine smaller versions built at National Guard camps with capacity for 1,000.
Auditorium	Knights of Columbus	Wood framed, 60' by 100', built in National Army cantonments
Club building	Knights of Columbus	Wood framed, 40' by 100', chaplain's room and altar at one end, two types, built in National Guard camps
Libraries	Edward L. Tilton, New York	Wood frame, two sizes, 40' by 120' built in National Army cantonments and 40' by 93' built in National Guard camps. All with reading rooms for 200 people and two bedrooms at one end for staff. Fireplaces in some, enclosed porches in others. 36 built at National Army cantonments and National Guard camps.
YMCA Building	YMCA	Two designs, "E" variant (including an "E-2" style, see Figure 6.) used at National Army cantonments and "F" variety for the National Guard. Plan generally included an auditorium joined to a social wing by a passageway containing offices and hall. Wood framed, one-story buildings with broad bands of windows and double dormers.
Hostess House	YWCA	Designed by women architects to take care of women visitors to posts, up to three Hostess Houses were built at some larger cantonments. Built from a standardized design, they varied in size and style according to local conditions. Generally "bungalow-like" they were located near post entrances for easy access by visitors.

American Library Association, and the Young Men's Christian Association (YMCA). Later, the Young Women's Christian Association (YWCA) joined the effort by introducing the Hostess House to camps where nearly one-quarter of the YWCA's \$5,000,000 war chest was directed toward construction of these buildings. Figure 6 illustrates a "semi-military" YMCA community service building.

¹⁸ Moulton, Robert H., "Semi-Military Buildings in Army Cantonments", *The Architectural Record* (July, 1918), 27.

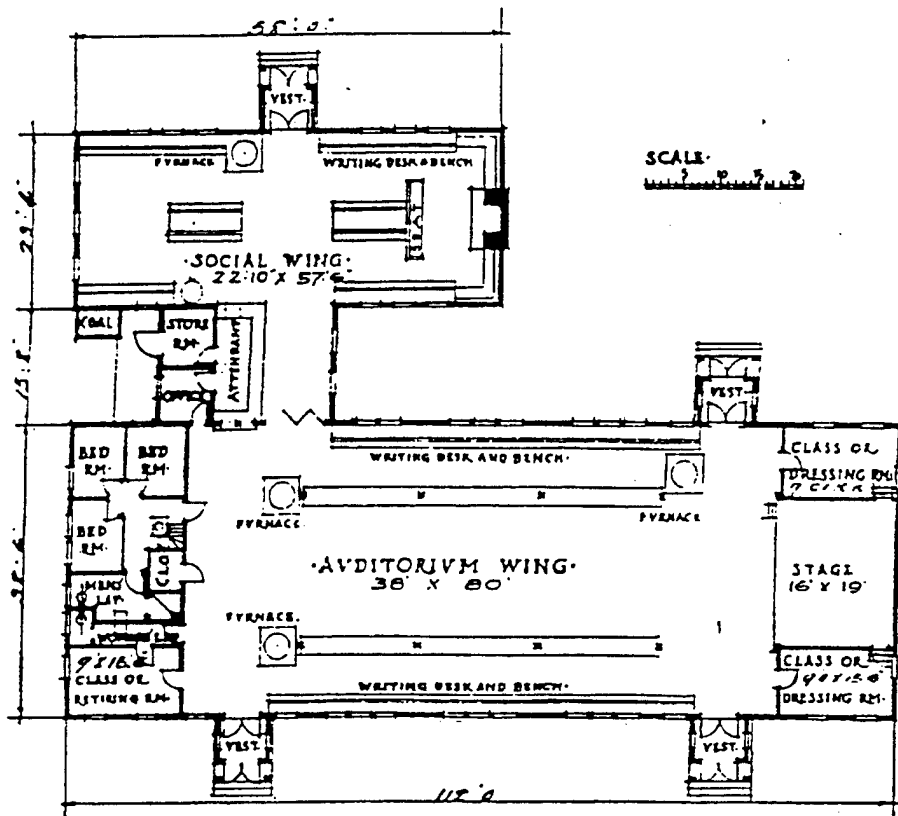

Figure 6. Plan of YWCA Building (Type E-2), a 1918 "semi-military" design. (Robert H. Moulton "Semi-Military Buildings in the National Army Cantonments", *The Architectural Record*, July, 1918, 24.

g. Conclusion

Buildings constructed from standardized plans have a strong element of *potential* historic significance. Taken individually, few of these buildings have a direct association with events; famous persons; an architectural type, period or method of construction. It is also unlikely that they would represent the work of a master, nor is a study of individual buildings likely to yield valuable historic information. Taken as a group, however, these buildings are significant for their design, construction and technological innovation. Techniques such as the standardization of plans, prefabrication of units, and assembly line approach to construction "were largely pioneered in the construction of these mobilization structures."¹⁹

6) DRAWINGS REPRESENTED IN THIS STUDY

The earliest standardized designs referred to in this study are two drawings from F.E. Warren Air

¹⁹ Arlene R. Kriv, Editor, *World War II and the U.S. Army Mobilization Program: A History of 700 and 800 Series Cantonment Construction*, (Washington: Historic American Building Survey/Historic American Engineering Record (HABS/HAER) National Park Service for Department of Defense, 1993), 3.

Force Base, formerly known as Fort D.A. Russel,²⁰ covering the period between 1885 - 1888. Only one drawing is included, as very few useable standardized Quartermaster drawings were found that pertain to the first period in either the National Archives in Washington, DC or at individual installations. In the second period (1890 to 1917), 216 drawings are referred to from Forts McPherson, Riley, Russel, Chaffee, and the *Manual for the Quartermaster Corps, 1916, Volume 2*. Included in this study are 39 drawings from the second period. Within the third period, (1917 - 1940), 240 drawings are referred to and 115 are represented in this study. Sources used were *Manual of the Construction Division of the Army, Section C, Engineering Division, 1918*, and drawing secured from Forts Russel, Riley, Lewis, McPherson, and F.E. Warren Air Force Base, Office of the Quartermaster General, the Chief of the Air Corps and Marshall Field. The name Fort Russel will be used in this study to refer to this installation, except when dealing with material pertaining to the Army Air Corps or the United States Air Force.

Drawings either included or referenced in this study from Forts Chaffee, Lewis, McPherson, Riley, and D.A. Russel, were taken from Quartermaster Corps building inventory sheets, real property record cards, and surveys of historic properties at these bases. Copies of War Department books containing Quartermaster Corps building inventory sheets, Form 117, were furnished by installations (See **Figure 7**). These documents were made shortly after construction in the 1930s and contain QMC standard plan numbers. Often they contain original photographs. Many real estate offices at individual posts also maintain a more modern system of real property record cards, DA Form 2877, for each building, see **Figure 8**.

Many standardized Quartermaster Corps drawings in this study are from Fort Riley, Kansas. Drawings from this post are well represented in this study for two reasons. First, the resources of this installation were accessible via the Internet and could be easily retrieved for research purposes. Second, and most significantly, Fort Riley contains excellent examples of Quartermaster Corps structures. In 1900, Fort Riley was the largest of 120 permanent posts constructed by the Quartermaster and could accommodate 1,300 troops. By 1940, Fort Riley possessed some 20,000 acres and was comparable in size to Fort Jackson, South Carolina and Fort Ord, California. Although Fort Riley is smaller than posts like Fort Bragg, Fort Benning, Fort Lewis and Fort Knox, it represents the well-developed Quartermaster utility and transportation systems and standardized building types.

²⁰ Researchers can find the appearance of several names throughout the history of a single post a daunting task to unravel. Fort D.A. Russell is a typical example of an Army fort that evolved, though several name changes, into an Air Force base. Established near Cheyenne, Wyoming in 1876 to protect Union Pacific Railroad workers from hostile Indians, Fort D.A. Russell became a large cavalry post and acquired artillery units in the early 1900s. In 1919, 125 aircraft were stationed at the fort's airfield. In 1930, President Hoover changed the post's name to Fort Francis E. Warren, honoring Wyoming's territorial governor. Quartermaster troops trained there during World War II and, in 1949, the post's name was changed to Francis E. Warren Air Force Base. The base was first used as a training facility and became part of the Strategic Air Command in 1958. It took on a mission of intercontinental ballistic missile operations at that time. The base operated Atlas D and E missiles, Minuteman I and IIIs, and Peacekeeper missiles. The Twentieth Air Force, headquarters for the nation's ICBM operations, is located at F.E. Warren AFB. (Source: <http://www.warren.af.mil/history>, October 9, 1997.)

1. FACILITY NO 1307		2. DESIGNATION GEN STOREHOUSE		3. CATEGORY CODE 44270-44220		4. DESIGNED CAPACITY		5. TOTAL AREA 1092 SF	
6. UNIT OF MEASURE			7. DRAWING NO. 19-2-79		8. MAP ID		9. <input type="checkbox"/> LEASED <input checked="" type="checkbox"/> OWNED LEASE NO.		
10. AIR CONDITIONING			16. FIRE PROTECTION			18. TYPE OF CONSTRUCTION <input checked="" type="checkbox"/> PERM <input type="checkbox"/> SEMI PERM <input type="checkbox"/> TEMP			
a. TYPE			a. NUMBER			19. BUILDING DIMENSIONS			
b. CAPACITY			b. TYPE			4. MAIN BLDG 42' x 26'			
c. FLOOR AREA COND			17. MATERIALS			b. OFFSETS			
11. HEATING			h. FOUNDATION Concrete			c. WINGS			
a. SOURCE Furnace			d. FLOOR Concrete			d. BASEMENT			
b. FUEL Oil			e. WALLS 8" Tile			e. ATTIC			
12. HOT WATER FACILITIES			j. ROOF Asb Roofing Paper			20. TYPE OF CARD			
a. CAPACITY			c. SURFACE			<input checked="" type="checkbox"/> BLDG <input type="checkbox"/> MISC STR			
b. TEMPERATURE RISE			i. BASE			<input type="checkbox"/> UTIL DIST SYS <input type="checkbox"/> RAILROAD			
13. NO. USABLE FLOORS 1			14. OTHER MEASUREMENTS			<input type="checkbox"/> LAND <input type="checkbox"/> SURFACED AREAS			
15. UTILITY CONNECTIONS					21. REMARKS				
a. WATER		NUMBER	SIZE	CAPACITY					
b. SEWER									
c. ELECTRICITY									
d. GAS									
e. STEAM									
f. CONDENSATE									

DA FORM 2877
1 NOV 54

FORM 1163 3-751-133

REPLACES DA FORMS 5-46 5-47 5-49 5-50
5-51 AND 5-52 WHICH ARE OBSOLETE

REAL PROPERTY RECORD
(AR 735-27)

22. COST DATA				
VOUCHER NO	DATE COMPLETED	DESCRIPTION OF CHANGE	COST OF CHANGE	TOTAL COST
- -	Apr 1934	Original Bldg		\$ 2,035
V-1326-64	12/11/53	Renovate for use as Tool Rm, Incl Install 220 Cannon Heater, Cat chg fr 422 to 44270	\$ 444	\$ 2,479
V-4190-67	1/19/67	Bldg No. 91 changed to 1307	N/A	\$ 2,479
V-3675-70	12/10/69	Install Furnace & 275 Gal Tank	\$ 589	\$ 3,068
- -	6/10/70	Transcribed from WD AGO Form 5-47	N/A	\$ 3,068
SCF09	6/25/95	chgcated per AR415-28 from 44270 to 44220		
CATEGORY CODE 44270-44220		DESIGNATION General Storehouse		FACILITY NO 1307

Figure 8. Example of Form 2877 for a munitions storehouse built in 1934 from Quartermaster Corps standardized plans with drawing No. 19-2-79. Fort Lewis, Washington.

B. METHODOLOGY AND GOALS:

1) OVERVIEW

This Standardized Plans Context provides background material needed to determine the historic significance of Army buildings constructed from 1866 to 1942. The study provides a framework within which standardized buildings constructed by the Quartermaster Corps in this period can be identified and evaluated for their historic significance. Identification and evaluation of historic properties is mandated under 36CFR60 and AR 200-4.

2) NATIONAL HISTORIC PRESERVATION ACT OF 1966

The National Register was authorized under the National Historic Preservation Act of 1966 as amended (Public Law 89-665) and serves as the nation's official list of historic sites and properties. The National Register criteria for evaluation define the nature and scope of the properties that are considered eligible for listing in the National Register of Historic Places.

The criteria for evaluation and criteria considerations are given in **Table 4** (following pages). These are the ground rules by which federal properties are evaluated for historic significance. Information about related significant properties may be grouped when they share common patterns or themes of history. Historic information organized in this manner is called a historic context. Historic contexts "are those patterns or trends in history by which a specific occurrence, property, or site is understood and its meaning (and ultimately its significance) within prehistory or history is made clear."²¹ The premise behind a context is that historic events are not isolated events but are part of patterns and larger trends that can be discerned for a particular period (see **Table 5**, following pages). The organization of a context is based on "a consistent framework: theme, geographical area, and chronological period."²²

Historic contexts provide installation managers with two valuable tools. They offer information that define and explain the historical reasons individual properties were developed. Contexts also provide managers with a standardized way to describe and explain the historic significance of diverse properties. They provide the foundation for decisions about identification, evaluation, registration and treatment of historic properties.

After a context is identified (including theme, geographical area and period) information about the context is gathered. Next, the information is synthesized in a written narrative to evaluate the events, patterns, persons, and architectural types that make up the context. Finally, property types are identified and the National Register criteria for evaluation are applied to examples as the important patterns, events, persons, and cultural values discussed in the narrative are identified.

²¹ Interagency Resources Division, National Park Service, "How to Complete the National Register Multiple Property Documentation Form" *National Register Bulletin 16B* (Washington, 1991) 11.

²² *Ibid.*, 1.

TABLE 4--THE NATIONAL REGISTER CRITERIA

CRITERIA: The quality of significance in American history, architecture, archeology, engineering, and culture is present in districts, sites, buildings, structures, and objects that possess integrity of location, design, setting, materials, workmanship, feeling, and association, and:

- A. That are associated with events that have made a significant contribution to the broad patterns of our history; or
- B. That are associated with the lives of persons significant in our past; or
- C. That embody the distinctive characteristics of a type, period, or method of construction or that represent the work of a master, or that possess high artistic values, or that represent a significant and distinguishable entity whose components may lack individual distinction; or
- D. That have yielded, or may be likely to yield, information important in prehistory or history.

CRITERIA CONSIDERATIONS: Ordinarily cemeteries, birthplaces, or graves of historical figures, properties owned by religious institutions or used for religious purposes, structures that have been moved from their original locations, reconstructed historic buildings, properties primarily commemorative in nature, and properties that have achieved significance within the past 50 years shall not be considered eligible for the National Register. However, such properties will qualify if they are integral parts of districts that do meet the criteria or if they fall within the following categories:

- A. A religious property deriving primary significance from architectural or artistic distinction or historical importance; or
- B. A building or structure removed from its original location but which is significant primarily for architectural value, or which is the surviving structure most importantly associated with a historic person or event; or
- C. A birthplace or grave of a historical figure of outstanding importance if there is no other appropriate site or building directly associated with his or her productive life; or
- D. A cemetery which derives its primary significance from graves of persons of transcendent importance, from age, from distinctive design features, or from association with historic events; or
- E. A reconstructed building when accurately executed in a suitable environment and presented in a dignified manner as part of a restoration master plan, and when no other building or structure with the same association has survived; or
- F. A property primarily commemorative in intent if design, age, tradition, or symbolic value has invested it with its own historical significance; or
- G. A property achieving significance within the past 50 years if it is of exceptional importance.

TABLE 5--EXAMPLES OF SPECIFIC HISTORIC CONTEXTS

INSTALLATION	CONTEXT
McChord AFB, WA	Impact of Air Corps Act and the Army Housing Program, 1926 Effect of Reorganization of Army Air Corps, 1935 Planning and Construction by the Quartermaster Corps, 1938-1941 World War II Era Use and Expansion, 1941-1946
Fort Huachuca, AZ	The Indian Wars and National Expansion, 1860-1890 Facilities Expansion, 1912-1917 Pershing's Expedition to Mexico, 1916 Quartermaster Construction, 1931
Fort McPherson, GA	Quartermaster Corps Design and Construction, 1885-1900 Role During the Spanish American War Evolution of Quartermaster Corps Depot System

3) STANDARDIZED PLANS AND HISTORIC SIGNIFICANCE

a. Introduction

The question most likely to be asked by an installation manager concerned with identifying or evaluating an Army building or structure constructed from standardized plans is likely to be, is it historic? A building or structure constructed from a Quartermaster Corps standardized plan is not automatically historic. However, the answer to the question is that any building or structure constructed from standardized plans has the *potential* of being historic. There are two questions to be answered before a building or a structure's historic significance can definitely be established.

b. Physical Integrity

A building constructed from a standardized plan is certainly representative of the formal, organized and large body of design work created by Quartermaster designers and architects. An individual building may also be associated with historic contexts of local, state or national significance (see examples in **Table 5**). The answers to questions about historic importance is often found in the building itself. The first question to be answered is whether or not the building has integrity. Defined as the ability of a property to convey its significance, there are seven aspects of integrity that may apply to a building or structure. A building will "always possess several, and usually most, of the aspects."²³ See **Table 6**.

TABLE 6 – HISTORIC INTEGRITY

Aspect	Definition
Location	The site where the building or structure was constructed. Except in rare cases the relationship between a building and its historic associations is destroyed if a building is moved. A regimental commander's house, built from standardized plans, and moved from its location with other regimental buildings into a group of similar houses for use as a guest house area would not, therefore, have integrity of location.
Design	The combination of elements that create the form, plan, space, structure, and style of a property. The design process, at the time of construction or during alteration, applies to community planning, engineering, architecture, and landscape architecture. Design reflects historic functions and technologies and aesthetics and includes the structural system; massing; arrangement of spaces; pattern of fenestration; textures and colors of surface materials; type, amount, and style of ornamentation; and arrangement and type of plantings in a designed landscape. Removing a gable roof from a 1920 gas station and replacing it with a flat roof would diminish the design integrity of a building.
Setting	The physical environment of an historic building or structure. Setting refers to the <i>character</i> of the place in which the property played its historic role. It involves <i>how</i> not just where a building is situated and its relationship to the surrounding features and open space. Setting often reflects the physical conditions under which a building was constructed and the functions it was intended to serve. The way a property is positioned in an environment can reflect the designer's intent and preferences. The long axis of the parade ground at Fort Lewis, for example, is oriented with nearby Mount Rainier at one

²³ *National Register Bulletin 15 How to Apply the National Register Criteria of Evaluation* (Washington, Department of the Interior, National Park Service, 1991) 45.

Aspect	Definition
	end and the Commanding General's house at the other.
Materials	The elements that were combined at a particular time or in a particular pattern to construct a building or structure. Materials reflect the choice of those who created the building or structure and indicate availability of particular types of materials and technologies and thereby help define an area's sense of time and place. Rehabilitation is acceptable in historic buildings if the key exterior materials and significant features have been preserved. Reconstructed or replicated buildings do not have integrity of materials.
Workmanship	The physical evidence of the crafts of a particular culture or people. Workmanship is the evidence of artisans' labor and skill. Workmanship can apply to a building or a structure as a whole or to its individual components. Vernacular methods of construction, traditional configurations and ornament, and the application of unique technologies are all evidence of workmanship. Other examples include tooling, carving, painting, graining, turning, and joinery.
Feeling	A building's expression of the aesthetic or historic sense of a particular time. Feeling results from the presence of features that, taken together, convey historic character. For example, an Army base on one of Alaska's isolated Aleutian Islands that has been deserted since World War II could evoke a sense of Army life in the Aleutian Campaign.
Association	The direct link between an important historic event or person and a historic building or structure. Association is present if it is the place where the event or activity occurred and it is sufficiently intact to convey that relationship to an observer. For example, an industrial area containing warehouses built during World War I would retain the quality of association with Quartermaster supply operations if the area and the warehouses have remained intact. Neither feeling nor association alone are sufficient alone to assure that a building or structure has physical integrity.

c. Historic Significance

Should a building have physical integrity, the second question becomes, does the building or structure have historically *significance*? Historic significance, as outlined in **Table 2**, is determined if a building or structure meets at least one of the four criteria for evaluation and, if applicable, the criteria considerations. Therefore, a building or structure may be considered historic only after it has been evaluated for physical integrity and historic significance and positive answers to both questions are documented. An excellent series of manuals, complete with instructions and examples, are available for installation managers who need to answer these questions. A partial list of manuals published by the Department of the Interior, National Park Service, Interagency Resources Division, Washington, DC includes the following.

Guidelines for Local Surveys: A Basis for Preservation Planning

National Register Bulletin 24

How to Apply the National Register Criteria for Evaluation

National Register Bulletin 15

How to Complete the National Register Registration Form

National Register Bulletin 16A

How to Evaluate and Nominate Designed Historic Landscapes

National Register Bulletin 18

d. World War II Temporary Buildings

The historic significance of World War II temporary buildings built from standardized plans has already been addressed in a comprehensive manner. In 1986, the Department of Defense addressed the problem of World War II temporary wood buildings in a programmatic memorandum of agreement with the Advisory Council on Historic Preservation and the National Conference of State Historic Preservation Officers. As a result of this agreement, amended in 1990, the Department of Defense prepared a history and archival documentation of WWII temporary wood buildings as mitigation prior to removing them. This policy does not apply to World War II temporary buildings that are contributing elements in established historic districts. The report resulting from this agreement is *World War II and the U.S. Army Mobilization Program: a History of 700 and 800 Series Cantonment Construction*, Arlene Kriv, Editor, Department of the Interior, National Park Service, U.S. Government Printing Office, 1993.

4) ORGANIZATION OF INFORMATION IN THIS STUDY

The standardized plans in this study have been divided into eleven major *types*, each containing from one to six sub-types (see **Table 7**). The type designations provide an efficient way to organize the vast number of standardized building designs developed by the Quartermaster Department, and later the Quartermaster Corps. The type designations were developed in *National Historic Context for Department of Defense Installations, 1790-1940*: and, for consistency, are used throughout this study.

TABLE 7--BUILDING TYPES AND DESCRIPTIONS

Type	Description
Administration	
1 a	Fire stations
1 b	Guard houses, sentry boxes
1 c	Headquarters, administration and office buildings
1 d	Post offices
Communications	
2 a	Radio buildings
2 b	Telegraph and telephone buildings
education	
3 a	Classroom buildings
3 b	Drill and riding halls
Health Care	
4 a	Dispensaries, infirmaries
4 b	hospitals
Industrial	
5 a	Maintenance and repair shops
5 b	Manufacturing
5 c1	Bakeries
5 c2	Laundries
5 d1	General storage
5 d2	Storage for ordnance
Infrastructure	
6 a	Power plants/electrical systems
6 b	Water and sewage systems and waste incinerators
Recreational, Social, Cultural & Religious	
7 a	Assembly halls
7 b	Athletic facilities

Type	Description
7 c	Chapels
7 d	Clubs (officer and non-commissioned officers)
7 e	Elementary schools
7 f	Post exchanges
7 g	Theaters
Research & Development	
8 a	Laboratories for research and testing facilities
Residential	
9 a1	Bachelor officer quarters and nurses quarters
9 a2	Barracks, dormitories and civilian housing
9 b1	Detached lavatories, bathhouses
9 b2	Mess halls
9 c1	Non-commissioned officers housing
9 c2	Officers housing
9 d1	Garages
Transportation	
10 a1	Airplane hangars
10 b1	Stables and stable complexes
10 c1	Gas stations
10 c2	Motor pools
10 d1	Railroad related buildings
MISCELLANEOUS	
11 a	Landscape Architecture / City Planning
11 b	Typical Buildings and Post Layouts

A database was developed for this study from information in the sources previously described. It contains data about specific standardized plans developed by the Quartermaster organization from 1866 to 1942. Five sorted tables containing data about individual standard plans, types, Etc., were derived from the database. These are included to help users navigate to useful information about individual standardized plans. Each table contains information under six headings (see **Table 8**). Because of space limitations, the following abbreviated headings were used in each table:

TABLE 8--LIST OF TABLE HEADINGS

HEADING	ABBREVIATION
TYPE	Alphanumeric designation for building type. <i>Types are sorted in ascending numeric order.</i>
STD PLAN	Standardized plan drawing number. <i>Not all Quartermaster Corps standardized plan numbers are listed. Sorted in ascending numeric order and thereafter alphabetically.</i>
DATE	Date of plan approval. <i>Sorted in ascending numeric order.</i>
BUILDING	Building name. <i>Sorted alphabetically by first letter of name.</i>
INSTALLATION	Installation where Standardized plan was located. <i>Sorted alphabetically by first letter of name. This is not a complete list of installations where particular plans were built.</i>
DRWNG	Copy of standardized drawing included in this study. <i>Inclusion is indicated by "X" in column.</i>

Each of the five tables contain identical data but the information therein is presented in different

formats. This enables users to easily search for and find specific facts about individual building types in this study. Information in the first table was sorted by Type, the second table was sorted by Standard Plan Number, and so on. In addition to providing a helpful place for researchers to begin looking for information about individual buildings, the tables also serve as an index of the standardized plans included in this study. In the examples below the data are sorted by *Type* (Table 9) and by *Standard Plan Number* (Table 10).

TABLE 9--SAMPLE TABLE SORTED BY *TYPE*

TYPE	BUILDING	DATE	INSTALLATION	DRWNG	STD PLAN
5 C1	Bakery	1902	Fort Riley, KS	X	49-H
5 D2	Magazine, Post Ordnance	1934	Fort Lewis, WA	X	19-2-70

TABLE 10--SAMPLE TABLE SORTED BY *STANDARD PLAN NUMBER*

STD PLAN	BUILDING	DATE	INSTALLATION	DRWNG	TYPE
152	B.O.Q.	1902	Fort Riley, KS	X	9 A1
152-B	B.O.Q.	1904	Fort McPherson	X	9 A1
152-E	Nurses Quarters	1906	F.E. Warren AFB		9 A1

5) USER'S MANUAL: HOW TO USE THE TABLES AND BUILDING TYPE CONTEXT STATEMENTS

a) A Practical Guide to This Study

Users of this study wishing to research a building on an Army or a former Army Air Corps post may begin by gathering basic information about the building. If the historic name of the building is known (Artillery Gun Shed, Hospital Corps Barracks, Stable, Etc.) or the number of the standardized plan from which it was built (120-F, 209, 610-233, 800-652, and so on), the tables sorted by *NAME* or *PLAN NUMBER* in Section 3 should be checked to see if the building has been listed under these categories. Researchers may also examine the table in Section 3 sorted by *DATE*²⁴. At this point, the user may find two items of useful information. The building's type will be found under the *TYPE* heading. Also, an "X" under the *DRWNG* heading will indicate that a copy of the drawing is included in the study.

If neither the name, plan number nor date is known, or if the building is not listed under any of the types and sub-type categories, users should decide which type and sub-type best describes the building. For example, the database includes many types of infirmaries but it was not possible to include all versions of standardized infirmary plans. Also, not all building types are included. Barracks for World War II prisoners of war, for example, are not specifically included as a type, but since these barracks were built from standardized plans they may be found under the "barracks" type, 9A2.

Upon isolating a type, by using the methods described above, users may turn to that particular building type context section of this study. Context statements for building types are located in

²⁴ This table is included to provide users with an overview of the range and distribution of dates covered in this study. Since the date of construction is later than the date on which the building's design was approved, researchers using this approach will be guided by an imprecise range of dates.

the section of this study. The alphanumeric symbols used as type designators are also used as a numbering system for context statements for individual building types located in the Section 2 of this study. Users will find a considerable amount of information about individual types here, also representative photographs and drawings. Information about each type is organized under the following headings in **Table 11**:

TABLE 11--HEADINGS USED IN TYPE CONTEXT STATEMENTS FOR INDIVIDUAL BUILDINGS

HEADING	DESCRIPTION
DESCRIPTION	Information having to do with a type's function, location, massing and materials
EVOLUTION	Information on the development of a type's standardized plans and its versions
ASSOCIATION	Addresses issues contained within the National Register Criteria of Eligibility, A-D, and the Criteria Considerations
INTEGRITY	Addresses how to determine physical integrity for a particular building type.

b) Integrity, Significance and the National Register of Historic Places

As noted, the key to determining if a building has integrity and significance lies in understanding and applying the *qualities* of integrity and the *criteria* of eligibility. Essentially guidelines, an understanding of a property's integrity and significance provide a framework by which any property can be evaluated. These guidelines exist to assure a uniformly fair evaluation for any building. It is important to note again that because a building was constructed from standardized plans does not mean it will be considered historic unless it has been evaluated within this framework and a positive analysis is obtained.

The responsibility for the identification, initial evaluation, nomination, and treatment of federal historic resources lies with installation commanders and state historic preservation offices. A consultation process between installations and state historic preservation offices is outlined in Army Regulations 200-4 (Chapter 2, Cultural Resources Compliance Requirements) 31 July 1996). The procedures for identification and nomination of federally-owned or controlled Army historic properties for listing in the National Register of Historic Places is given in AR 200-4, Chapter 3, Section 2.

Those properties that were built from standardized plans which are demonstrated to possess sufficient integrity and significance to be considered historic under provisions of the National Historic Preservation Act of 1966, as amended, are eligible for listing in the National Register of Historic Places. Maintained by the National Park Service, the National Register of Historic Places is the official list of recognized historic properties. The National Register documents the appearance and importance of districts, sites, buildings, structures and objects significant in our prehistory and history. It recognizes properties of local, state or national significance in American history, architecture, archeology, engineering and culture that are worthy of preservation.

The final evaluation and listing of properties in the National Register is the responsibility of the Keeper of the National Register. Installation commanders or their appointees who must decide if a federal property qualifies for the National Register of Historic Places should consult these

publications for guidance in actively dealing with issues of integrity and significance.

How to Apply the National Register Criteria for Evaluation

National Register Bulletin 15, National Park Service, Washington, DC

How to Complete the National Register Registration Form

National Register Bulletin 16A, National Park Service, Washington, DC

How to Complete the National Register Multiple Property Documentation Form

National Register Bulletin 16B, National Park Service, Washington, DC

6) RESEARCH AT THE NATIONAL ARCHIVES:

A number of Record Groups (RG) at the National Archives were of use in learning about and finding QMC standard plans. Researchers will find additional information about the contents of various record groups in the bibliography section. The principal Record Groups which contain information about standardized plans are

RG 92 - Office of the Quartermaster General

RG 107 - Office of the Secretary of War

RG 77 - Office of the Chief of Engineers

RG 336 - Office of the Chief of Transportation

The National Archives, normally a comprehensive source of valuable information, for the most part did not lend itself to research *for this project*. The Archives staff was unfailingly helpful and cooperative and the services of this modern facility were easy to use. In an effort to minimize the time and cost of reproducing drawings held at the National Archives, permission was secured to copy drawings using hand-held 35mm photography without flash. The results were disappointing. (See **Figure 9**) Most drawings were sealed into archival sleeves and neither could, nor should they, be removed from these holders. The sleeves have a very high, glossy finish which caused disappointing reflections in almost every photograph. A very few plans were not yet encased in archival envelopes, photographs of these plans were successful.

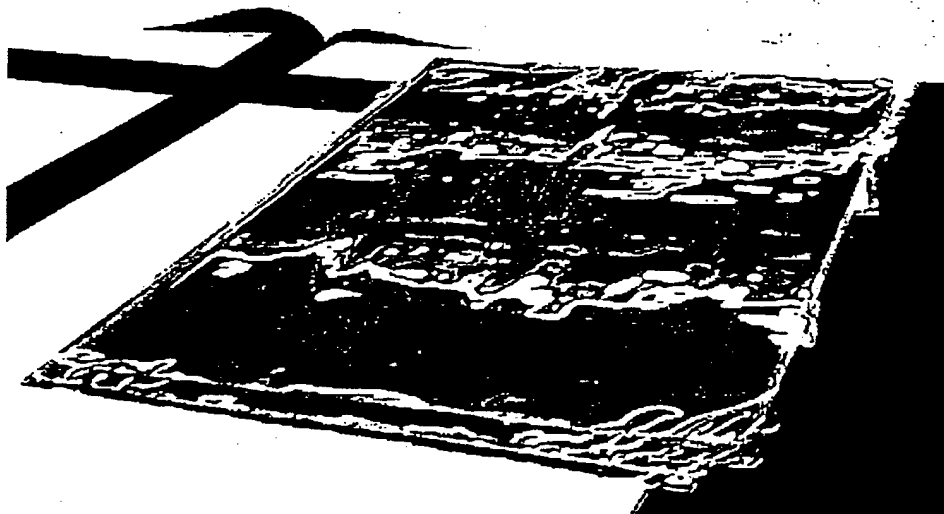

Figure 9. View of QMC standardized plan sealed into protective envelope in the holdings of the National Archives. Note reflections from overhead lights and effect on photograph.

7) ASSISTANCE FROM INDIVIDUAL POSTS:

Research at or letters requesting copies of standard plans and/or historic surveys were sent to the following installations:

Aberdeen Proving Ground	Fort Gillem	Fort Monroe
F.E. Warren AFB/Fort Russell	Fort Huachuca	Fort Riley
Fort Belvoir	Fort Leavenworth	Fort Sam Houston
Fort Benning	Fort Leonard Wood	Fort Sill
Fort Bliss	Fort Lewis	Schofield Barracks
Fort Bragg	Fort McPherson	Watervliet Arsenal
Fort Chaffee	Fort Meyer	

While some posts could not assist, others had sufficient material on hand (building inventories, surveys, National Register of Historic Places nomination forms, Etc.) that they could send copies.

8) TRANSFERRING FILES VIA THE INTERNET

An efficient compromise was found that could lift the burden from individual posts. In this matter, cooperation from Fort Riley was outstanding. At that post, approximately 2,000 historic Quartermaster Corps drawings had been scanned and stored as individual digital files. These files were imported, via the Internet, to the Seattle District. This was a very lengthy and time-consuming process involving making and maintaining modem connections between a work station in the Seattle District's Architecture Section, Seattle's Engineering Local Area Network (LAN) and the Fort Riley LAN.

Files were stored at Fort Riley in a .CIT graphic software format which is not compatible with the Seattle District's drafting software. Fortunately, the files could be read using I/RAS-B software, thereby adding an extra step to a complicated operation. The transfer and translation process was very time-consuming, but benefited the study in two ways:

- QMC files were cleaned by deleting patches of gray and meaningless dots copied with the original drawings. This also took additional time but the results were often worth the effort, particularly when information was revealed under the "chaff".
- The clean drawings have been plotted onto 8.5"x11" paper, an ideal size for three-ring binders and well suited for use on standard copying machines and scanners.

C. QUARTERMASTER CORPS HISTORIC CONTEXT:

1) OVERVIEW OF THE QUARTERMASTER CORPS HISTORY: 1775 TO 1942

The story of the Quartermaster Corps begins in 1775, when the Continental Congress established the Quartermaster's Department as the Army's supply agency. The Department's mission was to transport troops, construct buildings, store and issue supplies and support armies in the field. It was abolished after the Revolutionary War and its former supply duties undertaken by civilian contractors. Until 1812, the Quartermaster's responsibilities were managed by a "kaleidoscopic succession of quartermasters, contractors, and agents variously named" and supervised by either the departments of Treasury or War.²⁵

During the War of 1812, the Quartermaster's Department was re-established. It took on transportation and construction duties, although sharing the supply role with the Commissary General of Purchases. In 1818, a separate Subsistence Department, responsible for providing the Army with food, came into operation under a Commissary General. By 1826, the Army's supplies followed a circuitous route: the Commissary General of Purchases procured the Army's clothing and equipment, transferred these supplies to the Quartermaster's Department, which distributed them to troops. It was not until 1842 that the Commissary General of Purchases was absorbed by the Quartermaster Department and its main depot²⁶ "became the cornerstone of the great system of Quartermaster Depots."²⁷

Until the appointment in 1818 of Lt. Col. Thomas Jesup, the position of Quartermaster General only existed in time of war. During his 42-year long administration, the Department grew to become a permanent staff agency for the War Department. Largely improvised during these early years, facilities at posts (particularly near the Indian campaigns) were generally built by troops to plans designed by the garrison commander. The Department's organization during this period developed slowly although the Department recognized "the importance of established depots to the movement and distribution of supplies over long distances."²⁸ Between 1820 and 1840, the Quartermaster's Department and the Army Engineers both built military roads. Roads in Louisiana and Arkansas were completed and the highlight of the Department's road building was the great military road of 1836, championed by Jesup. Completed in 1841, this road connected a line of posts along the frontier between the Indian and white settlements from the Upper Mississippi River to the Red River in the south.

The Civil War marked the country's first experience with large-scale mobilization efforts requiring the nation's attention. Responding to this challenge, the Quartermaster General's office established a "commodity-type" organization to supply the Union Army through a depot system. This system was characterized by the purchase and distribution of specific types of

²⁵ Risch, Erna, *The Quartermaster Corps: Organization, Supply and Services, Volume I* (Washington, D.C.: Office of the Chief of Military History, United States Army, 1953), 3.

²⁶ The Schuylkill Arsenal became the Philadelphia Quartermaster Depot. Army clothing was procured and made there for more than a hundred years.

²⁷ Risch, Volume I, 4.

²⁸ Risch, Volume I, 4.

supplies (commodities) that were handled by *separate* Quartermaster branches. During the Spanish-American War, organization broke down under the pressure to supply an army struggling to function at ten times its pre-war size. In an effort to fix the problem, in 1912, the Army consolidated the Subsistence, Pay, and Quartermaster's Departments into the Quartermaster Corps. Not only did this place these functions in a single, centralized agency with a new name, it also gave the Corps responsibility for feeding and paying the Army. Prior to 1912, the Department had also been charged with managing the Army's real estate actions, running its utilities, and other tasks including the operation of national cemeteries.

Essentially unchanged, the commodity-type organization was maintained by the Department until World War I. By then the organization of the Office of the Quartermaster General had evolved to include five divisions: Administrative, Finance and Accounting, Construction and Repair, Transportation, and Supplies. At installations, post and camp quartermasters distributed supplies received from territorial department quartermasters who, in turn, received supplies from seven general depots and several specialized depots²⁹ where supplies were procured.

A major difficulty encountered early in World War I was overloading at storage facilities at east coast ports. Long lines of loaded railroad cars were left for days on railroad sidings leading to ports, creating back-ups and making a near-impossible task out of finding critical supplies to load onto ships. Later, when additional warehouses were built and leased, these delays became a thing of the past. Also helping to dilute the commodity-focused organization was the institution of a zone system that assigned geographic areas to depots. This restructuring allowed Quartermaster depots to supply posts in their region with all supplies instead of a specialized few. After the war, however, the zone system was abandoned.

During World War I, the construction function was transferred from the Quartermaster Corps to a separate Cantonment Division and water-borne transportation was taken over by the Embarkation Service. While the organization was now decentralized, it had also reverted to a commodity-centered one which remained in place during World War I. Faced with a desperate need for centralization to effectively meet the demands of manufacturing for the Allies, for the government, and for the civilian population, the War Department temporarily reorganized all the supply bureaus under the General Staff "along functional lines." At the end of the war, the Quartermaster Corps became part of the Purchase, Storage and Traffic Division

The National Defense Act of 1920 re-created the Quartermaster Corps as a separate service and restored the construction and transportation responsibilities, but not the pay function. The organization was to remain firmly commodity-centered for the next two decades. Organized now into four divisions (sometimes called "services"), these were: Administrative, Supply, Construction, and Transportation. Both the Construction and Transportation divisions were established as self-contained, independent agencies so they could adapt to future national emergencies. Faced with lean inter-war years and reduced military budgets, the Quartermaster Corps slid from a position of war-readiness to one suited to taking care of peacetime business. There was no single agency to supervise operations and, in the depots, the emphasis was on

²⁹ These included the Boston Depot for footwear, and the Jeffersonville Depot for wagons and harness.

accountability of supply officers for property in their control rather than efficient storage and evenhanded distribution.

In 1939, as World War II began in Europe, the Quartermaster Corps remained organized along commodity lines. Although the Corps strength (and its responsibilities) expanded to keep up with the tremendous growth of the Army, the organization remained commodity-based until around the time of Pearl Harbor. Accustomed to supporting a peacetime Army and faced with supplying a war that would be fought with new technology, "supply problems grew more complex and modern methods of warehousing had to be adapted to the Army."³⁰ In 1940, there were twelve Quartermaster depots; only two were located west of the Mississippi River (see **Table 12**). The depot system was reorganized and divisions made responsible for the procurement, storage or distribution of nearly all types of supplies. In 1941, the Depot Division was created to develop standard practices and coordinate depot activities on a nation-wide basis.

TABLE 12--QMC DEPOTS IN 1940³¹

Boston Quartermaster Depot	New Orleans Quartermaster Depot
Chicago Quartermaster Depot	New York General Depot
Columbus General Depot	Philadelphia Quartermaster Depot
Eighth Corps Area Depot (Fort Sam Houston)	San Antonio General Depot
Jeffersonville Quartermaster Depot	San Francisco General Depot
New Cumberland General Depot	Schenectady General Depot

Until mid-1942, the Depot Division worked closely with the Construction Division in planning and designing a new, larger depot system to deal with dramatic changes the Army was making in response to the national emergency. New buildings were either constructed or leased, although leasing was avoided whenever possible as it generally meant costly remodeling, questionable fire protection and sometimes poor locations for access to rail and ship facilities.

Single-story warehouses were designed to accommodate railroad cars "with loading platforms level with the car floor on one side ...and docks for truck loading and unloading on the other side."³² These buildings were generally designed with unlimited floor load ratings and high ceilings to allow stacking materials in tiers, and the operation of forklifts. Large, flat undeveloped areas or small towns were preferred to urban sites so great numbers of warehouses could be built and widely separated for fire prevention. The Construction Division, faced with an urgent need for many buildings completed quickly and on time, used cost-plus contracts to expedite building depots. Despite shortages of critical materials like steel, and occasional labor disputes, the Construction Division completed much of the expansion program by mid-December 1941, when all construction was turned over to the Corps of Engineers.

At the peak of World War II, the Quartermaster Corps supplied nearly 8,000,000 Army men and women with food, clothing, shelter, equipment and general supplies. It also provided the Navy,

³⁰ Risch, Volume II, 323.

³¹ Risch, Volume II, 331.

³² Risch, Volume II, 333.

Marine Corps, Coast Guard, War Shipping Administration and even the Lend-Lease program³³ with supplies. Procurement of subsistence (food) was done at a national level. Research laboratories were established to apply science and technology to the war effort, and new methods were developed for efficient procurement, storage and distribution of materials.

2) ARCHITECTURAL STYLES

It is hardly surprising that Quartermaster designers used several popular architectural styles in developing standardized plans, just as their civilian counterparts designed buildings in popular styles to please clients, developers and speculators (see **Table 13**). For example, following close on the boisterous Victorian era of the late 1800s, the Colonial Revival style gained popularity as a wave of patriotism, combined with an increasingly mature national awareness and a desire to return to the “good old days” swept the country. If the middle class was attracted to Colonial Revival buildings, new in the 1890s and 1900s, so were the architects who designed them for the Army and the members of congress who appropriated funds for their construction. Quartermaster designers, however, generally exercised a restrained hand in applying styles to their buildings and structures. Many construction projects were driven by a need to economize on costs and to stretch funding as far as possible. Also, the Army was a naturally conservative client and neither wished for nor was likely to pay for flamboyant designs. There were exceptions, but more often than not, these exceptions simply proved the rule³⁴.

Users of this study should refer to published works on American architectural styles for guidance on applying these labels to buildings or structures.³⁵ Architectural styles have evolved as useful ways of describing architecture and characterizing the philosophy and beliefs of a period that gave birth to a particular style. By nature imprecise, architectural styles define broadly the

³³ After Roosevelt's re-election in 1940, the President announced a policy of “all-inclusive national defense” and committed his support to “all those resolute peoples, everywhere, who are resisting aggression and are thereby keeping war away from our Hemisphere.” [Samuel I. Rosenman, *Franklin D. Roosevelt, The Public Papers and Addresses, Volume IX* (New York, The Macmillan Company & Harper & Brothers, 1940) 666-667.] Congress passed the Lend-Lease Act and the President signed it into law on March 11, 1941. Initially designed to provide Great Britain with military aid, the Lend-Lease program was eventually extended to other European nations and to many other countries world-wide. The Act empowered the president, “in the interests of national defense,” to “manufacture ...or otherwise procure ...any defense article for the government of any country whose defense the president deems vital to the defense of the United States.” [Raymond H. Dawson, *The Decision to Aid Russia, 1941* (Chapel Hill, North Carolina: The University of North Carolina Press, 1959), 9.] The Soviet Union was the recipient of the bulk of Lend-Lease aid, including over 8,000 aircraft, 3 million tons of steel, 4 million tons of copper, and ships, trucks, tanks. The USSR also received non-military items such as “cigarette cases, records, women's compacts, fishing tackle, dolls, playground equipment, cosmetics ...and even 13,328 sets of false teeth.” In 1944, “two percent of the nation's food supply was exported to the Soviet Union, four percent to other Lend-Lease recipients, 1 percent in commercial exports and 13 percent to the United States military.” [Alexander B. Dolitsky, “the Alaska-Siberia Lend-Lease Program”, *Alaska at War* (Anchorage: Alaska at War Committee, 1995), 333-338.]

³⁴ The Administration Building (No. 100) known as “The Taj Mahal” at Randolph Air Force Base, Texas is one such example.

³⁵ The following style guides are among many excellent published works. Poppeliers, John C.; Chambers Jr., S. Allen; and Schwartz, Nancy B., *What Style is it?*, (Washington, DC, National Trust for Historic Preservation, 1983). Massey, James C. and Maxwell, Shirley, *House Styles in America* (New York, Penguin Studio, 1996). McAlester, Virginia and Lee, *A Field Guide to American Houses*, (New York, Alfred A. Knopf, 1984).

TABLE 13--SUMMARY OF ARCHITECTURAL STYLES AND PERIODS
USED IN SOME QUARTERMASTER BUILDING TYPES

TYPE	ARCHITECTURAL STYLE	DATE
Guard Houses, Gatehouses, Sentry Boxes	Late Victorian	1880-1890
	Colonial Revival	1900s
	Georgian Revival	1920 - 1930
Headquarters, Office and Administration Buildings	Spanish Colonial Revival	1920 - 1930
	Late Victorian	1880 - 1890
	Colonial Revival	1894, 1900s
	Georgian Revival	1930s
	Spanish Colonial Revival	1930s
Hospitals	French Colonial Revival	1930s
	Victorian Elements	Late 1800s
	Colonial Revival	1900s
Chapels	Spanish Revival	1900s
	Gothic Revival	1850-1903
	Neoclassical	1900s
	Gothic Revival	1930s
	Georgian Colonial Revival	1930s
Post Exchange	Spanish Colonial Revival	1930s
	Georgian Revival	1920 +
	Spanish Colonial Revival	1920 +
Bachelor Officers Quarters & Nurses Quarters	Victorian	1880-1890
	Colonial Revival	1894-1940
	Spanish Colonial Revival	1911
	Georgian Revival	1930s
	Romanesque	1880-1890
NCO Housing	Queen Anne	1880-1890
	Bungalow	1926
	Spanish Colonial Revival	1930s
Officer Housing	Georgian Revival	1930s
	Georgian Revival	1860
	Italianate	1880-1890
	Romanesque Revival	1880-1890
	Queen Anne	1880-1890
	Colonial Revival	1890-1910
	Spanish Revival	1890-1910
	French Provincial	1930s
	English Tudor Revival	1930s
	Bungalows	1930s
Art Moderne	late 1940s	

attributes of a style, but their interpretation is ultimately left to the researcher. Styles are visually determined and are not related to use or function: officer housing, administration buildings and chapels may all be built in a single style. Even published definitions of architectural styles contain inconsistencies. What one author may simply term "Victorian", another defines, with greater clarity, as Second Empire, Romanesque Revival, Queen Anne, Stick and Shingle Style, and Mail Order Designs (see Table 14). Styles have also regained popularity after periods of disuse. The Georgian (1740-1790) and Spanish Colonial (1565-1797) reappeared in altered form in the Georgian Revival (1859-1920) and Spanish Colonial Revival (1915-1930). Even the dates assigned to styles only define when they were in popular use and should be viewed as

guideposts, indicating when a style appeared and when it generally fell from public favor. Also, the periods when styles were in popular use tend to overlap and do not begin and end in a linear fashion. Finally, builders and architects in some localities often continued to use a particular style when it was no longer widely used elsewhere.

TABLE 14--CHRONOLOGY OF ARCHITECTURAL STYLES

STYLE	DATES	USED EXTENSIVELY BY THE QUARTERMASTER
Colonial	18th Century	
Georgian	1740-1790	
Federal & Roman	1790-1830	
Greek Revival	1820-1860	
Gothic Revival	1830-1875	X
Italianate	1840-1890	X
Second Empire	1855-1885	
Romanesque Revival	1870-1900	X
Queen Anne	1870-1910	X
Stick & Shingle	1870-1905	
Beaux Arts	1880-1940	
Colonial Revival	1890-1940	X
Bungalows & Arts & Crafts	1900-1930	X
Prairie Style	1897-1921	
Builder Style	1895-1930	
French Revival	1915-1940	
Spanish Colonial Revival	1890-1940	X
Art Deco	1920-1950	X
International Style	1935-1950	

Even within styles, a certain amount of blending is found as designers took inspiration from a preceding style. The Queen Anne style, for example, borrowed elements of Georgian and Federal styles; the "Victorian" styles mentioned above (1860-1900) borrowed heavily from the Medieval period. Even within the Victorian era, styles tend to overlap and are not so distinctly different as the preceding Greek, Gothic and Italianate styles (1820-1880). Not all buildings are easily characterized as being of one particular style, although it is generally possible to pick out elements that identify a building as belonging predominately one style.

3) 1866 TO 1890: FIRST PERIOD OF STANDARDIZATION

From 1860 to 1890, the Army began its evolution into a modern military force as it abandoned its small temporary frontier posts and consolidated troops into larger regional installations. The need for new, larger, permanent installations required a higher degree of planning and design for buildings as well as post site plans. Building and post designs benefited from the Quartermaster Department's efforts to begin improving living standards by integrating water, sewage and heating systems into the design process. Post layouts expanded with the Army's new housing provisions for hospital stewards and non-commissioned officers. When the Army began to contract work to civilian architects at posts near urban areas, mid-nineteenth century American architecture and planning began to influence both Army building and post designs. Buildings incorporated simplified versions of nationally popular architectural styles such as Italianate,

Romanesque Revival, and Queen Anne. Installation planning was influenced by national trends in suburban design as some posts began to incorporate curving residential streets and large open spaces into their site plans.

In the 1860s, and parallel to the Army's rapid expansion, a movement began within the Army to standardize plans and designs, making construction more cost-effective and efficient. The first Army standardized plans were developed in 1861 "when the U.S. War Department published *Regulations Concerning Barracks and Quarters for the Army of the United States*."³⁶

Unfortunately, these regulations were never adopted. However, attention was given to developing standardized barracks plans and a design by Henry Roscrans developed in 1847 was used as a standard plan. In 1863, Army regulations

gave 225 square feet per man for posts located north of 38 degrees North latitude and 256 square feet per man for posts located south of that line. The height of the rooms was to be 10 feet, giving a man north of 38 degrees north latitude 375 cubic feet of space and a man south of 38 degrees North latitude 426 cubic feet. If, however, the number of officers and soldiers made it necessary, a commanding officer could reduce these amounts--and he usually did.³⁷

Grashof, writing in *A Study of United States Army Family Housing, Standard Plans, 1866-1940*, notes that standardized plans for family housing for officers and non-commissioned officers were developed around 1866 as part of a large series "which included plans for a school house, mess hall, bakery, jail, chapel and barracks."³⁸ The financial situation in the Quartermaster Corps was generally so poor that Quartermaster Generals "continually complained of having too little money to provide the necessary quarters for the Army."³⁹ It was these conditions that led Quartermaster General Montgomery C. Meigs to write in 1872: "...[I] have now, I believe, succeeded in developing a set of plans for every military post...Standardized plans for temporary barracks and quarters at military posts in the west have been prepared and distributed."⁴⁰ Meigs' plans were widely distributed and, as Grashof notes, built not only in the west but at Governors Island and Madison Barracks in New York and at Fort Adams, Rhode Island. It is not known who did the actual design work but, as Grashof indicates, they were probably developed by technical staff within the Quartermaster General's Office. At the western posts, which were considered temporary by the Army, the War Department preferred "to keep the troops in cantonments, occupying quarters they themselves constructed from local materials."⁴¹

During this period, standardized plans were not used universally by the Army as "much of the standardization at this time took place within regional military departments. The Departments of the Dakota and the Platte seem to have been especially active and many of their designs were

³⁶ Grashof, 9. Quoting U.S. War Department, *Regulations Concerning Barracks and Quarters for the Army of the United States* (Washington: George W. Bowman, 1861).

³⁷ Risch, 733.

³⁸ Grashof, 9.

³⁹ Grashof, 9.

⁴⁰ U.S. War Department, *Annual Report of the Secretary of War*, 1872.

⁴¹ Risch, 487.

variations on Meigs 1872 plans.⁴² (Figure 10.) There is evidence that builder's handbooks, also known as pattern books, were used as source books by the Quartermaster design staff.

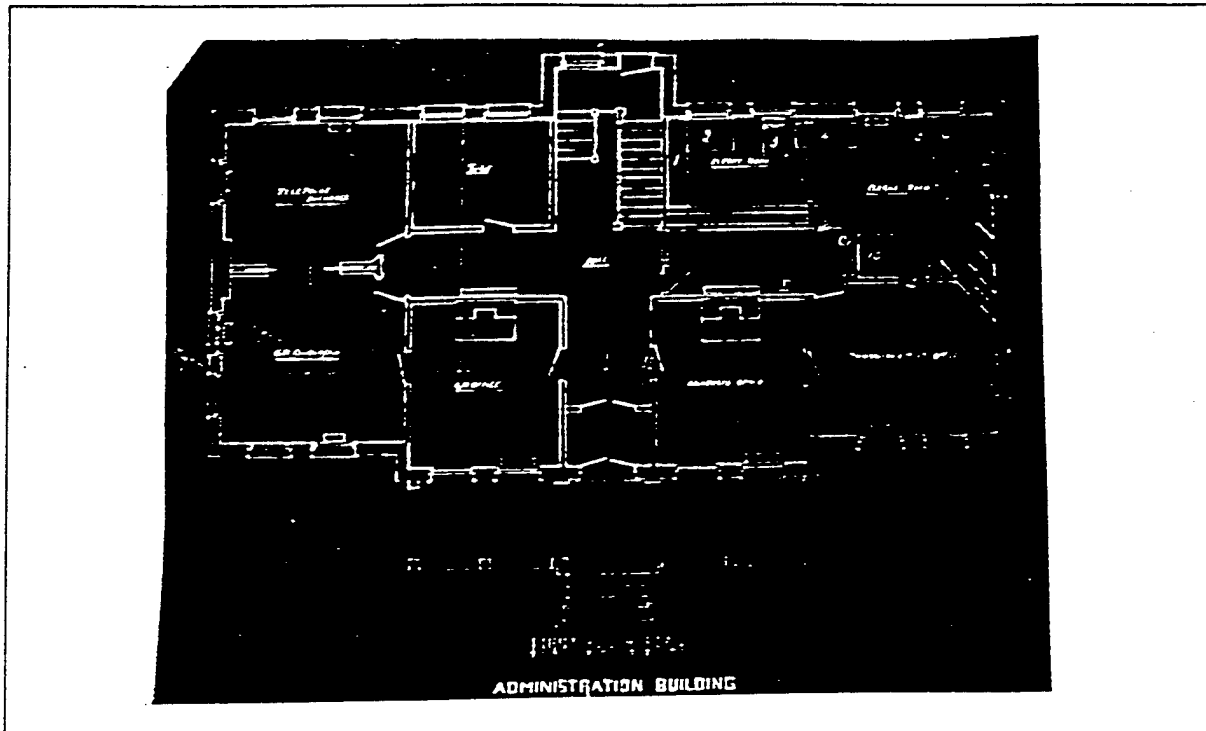

Figure 10--Plans by the Department of the Dakota for an Administration Building, based on Quartermaster General Meigs plans.

Throughout the 1880s, the Army was criticized for its poor living conditions. The Surgeon General's Office viewed the inadequate quarters, heating, ventilation and sanitary systems with strong criticism. Facing increased construction costs and armed with insufficient funds, the Quartermaster Department undertook "an ambitious program of standardization."⁴³ This effort came at a time when the Army was considering abandoning the temporary western posts and concentrating troops in large, permanent ones.

a) Army Post Development. Layout and Styles:

From the beginnings of post development and layout, Army posts throughout the country reflected many different landscape designs as well as architectural styles. In many cases, the preferences of an individual post commander greatly influenced the layout and design style of a particular post.

The layout of early frontier posts (1790-1875) was primarily dictated by the need for protection as the Army moved to secure the interior of the nation and its borders. Most of these posts were small temporary frontier garrisons, and while they varied in design and style according to available materials and the post commanders' influence, they conformed to a general

⁴² Grashof, 19.

⁴³ Grashof, 28.

arrangement. Early posts of the old Northwest (now Ohio, Indiana, and Wisconsin) usually had an encircling wooden defensive wall, corner blockhouses, and quarters, storage and shop buildings within (Figure 11).

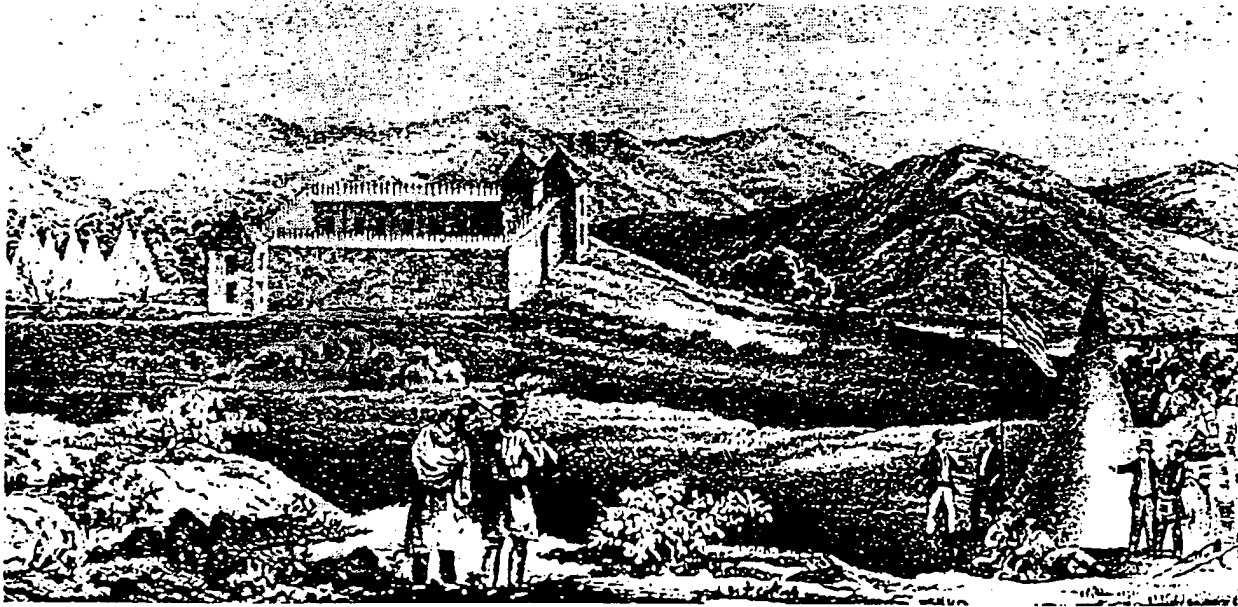

Figure 11—Fort Laramie, 1842. National Archives.

After the frontier moved west of the Mississippi, the spatial arrangement of frontier posts evolved. Gradually the palisade disappeared as a protective fortification. The parade ground became more pronounced as the center of the post with barracks, officers' housing, and administrative buildings surrounding the parade ground. Various service areas were located apart from the central parade ground: an infirmary or hospital; guardhouse; agricultural fields; and, shops. Stables for cavalry troops were located close to the barracks, while corrals and storage facilities were located apart from main parade ground area."⁴⁴ Fort Riley, Kansas is a good example of a typical frontier post plan (Figure 12.)

⁴⁴ Goodwin and Associates, 154.

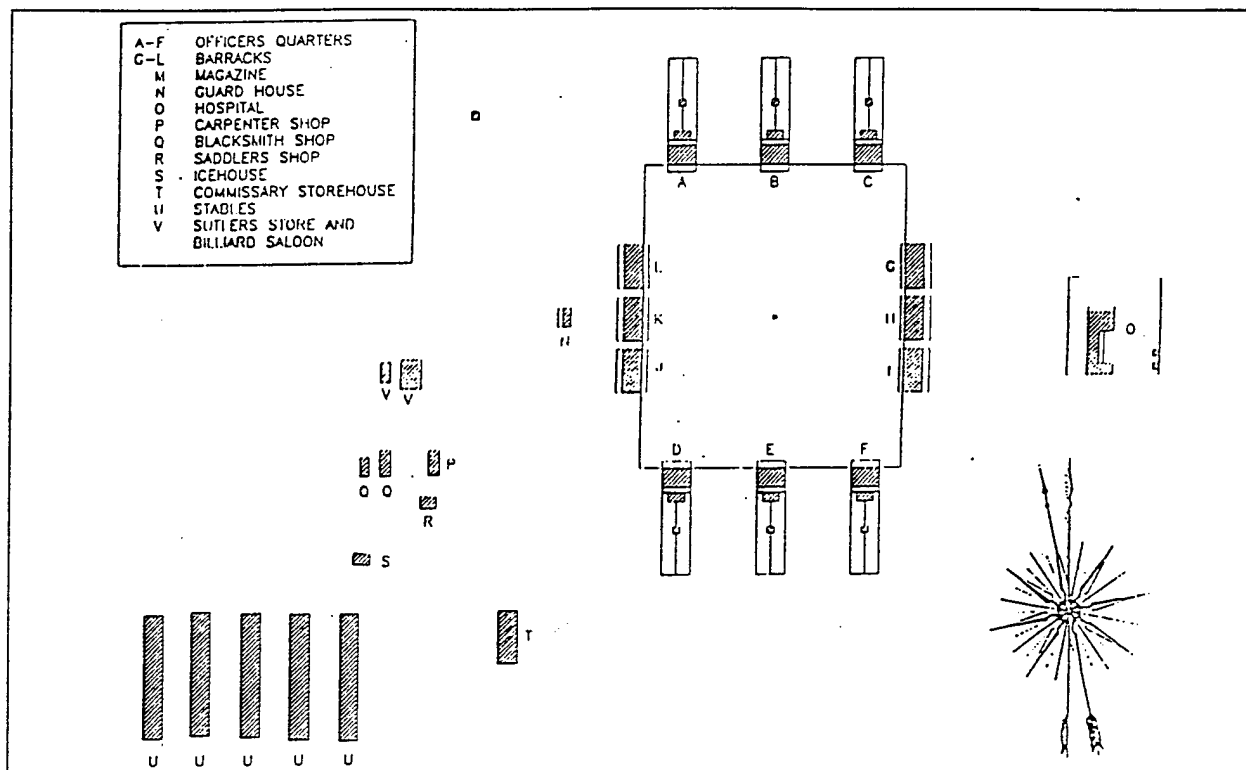

Figure 12--Layout of Fort Riley, Kansas, showing the typical arrangement of buildings at western frontier posts.

To date, the only evidence of efforts to standardize Army post plans during the Frontier Post era are found in unofficial 1860 regulations. These regulations suggested the following arrangement of a four company garrison (Figure 13):

Plan of a Garrison. Officers' quarters, chaplain's quarters, and officers' mess on one line, facing a parade ground open at both ends and varying in breadth at different posts, according to the ground and other circumstances, from 250 to 400 feet; all other buildings on the other side from the officers' line, and in positions to be presently described. On that side an avenue 220 feet wide extending outward perpendicularly from the parade ground, will separate the troops from the supplying departments another avenue 200 feet wide, parallel to the first, and 300 feet from it, will separate the supplying departments from the sutler's establishment and the hospital ground...⁴⁵

⁴⁵ Ibid., 154

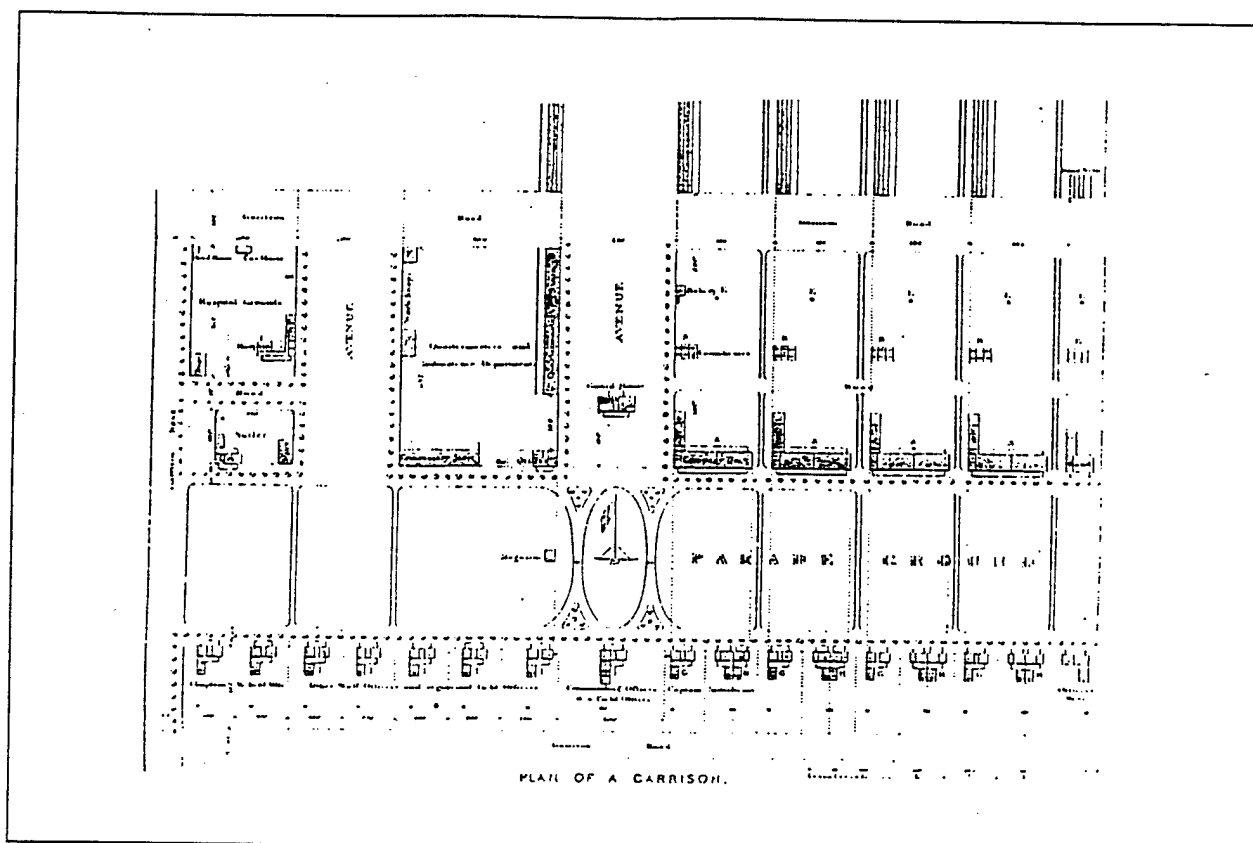

Figure 13--Proposed plan for a typical garrison, 1860. (From U.S. War Department, *Regulations Concerning Barracks and Quarters for the Army of the United States, 1860* [Washington, DC: George Bowman, Printer, 1861.]

Landscape character-defining features depicted on the 1860 proposed standardized plan include overall organization (site plan-buildings, roads, parade ground), land use areas (quarters, administration, supply areas, medical, etc.), building clusters, and vegetation (trees line several roads and the perimeter of the parade ground).

Although the 1860 regulations were not officially adopted, according to sketch maps in an 1876 Army publication, *Outline Descriptions of the Posts in the Military Division of the Missouri*, the overall arrangement and layout of existing posts appeared to follow the 1860 guidelines.⁴⁶

From the 1880s and into the 1890s, Quartermaster designers used the Victorian style for administration buildings. Simplified versions of Romanesque and Queen Anne styles were applied to barracks during this time period.

4) SECOND PERIOD OF STANDARDIZATION: 1890 - 1917

By the 1890s, as the nation mobilized for the Spanish American War and continued to fight in the Philippines, the Army's size grew from around 25,000 troops to an average of 65,000, a

⁴⁶ Goodwin, pp. 154.

number that held steady for the next decade. During this period of rapid growth, the Army's needs for permanent buildings increased proportionally. Review boards examined 65 existing posts to determine how many the Army needed to keep. Fifty-two posts were to be kept permanently, the remaining 13 to be occupied temporarily and 7 new posts were recommended. In 1903, the Quartermaster Corps increased the number of architects and draftsmen of its Construction Division "and hired an experienced architect to direct the revision of drawings and improve the general appearance of the buildings."⁴⁷

Annual Reports of the Quartermaster General for this period indicate a growing concern with rising construction costs and a preoccupation with lowering new construction costs. From 1902 to 1905, construction costs rose 36%, and in the next year jumped an additional 12%. Large timbers, lumber, and wood flooring were replaced by concrete and iron construction. New systems of heat, water, and sewerage and electric or gas lighting "added to construction costs but provided for modern, comfortable accommodations."⁴⁸

To manage these changes and reduce new construction costs, existing plans were rearranged and wasted space eliminated to create smaller buildings "without sacrificing convenience".⁴⁹ Exterior detailing was modified and plans changed so materials of standard dimensions could be used. After 1910, a 33% savings was sustained by using concrete instead of brick. This period is characterized by the appearance of some standardized plans, but no regional variations were incorporated. There was the option to use either brick or wood frame and there were occasional stone or concrete variations. The same building was offered and built wherever there were Army posts.

During this period and the early part of the next, civilian architects often used styles popular at the time, simplifying these styles for the Army's taste and budget: Italianate, Romanesque Revival and Queen Anne. Site layouts at posts were also effected by civilian architects like George E. Pond and William Goding at Fort Riley, Gustav Freibus at Fort McPherson, Holabird and Roche at Fort Sheridan, E.T. Carr at Fort Leavenworth, F.J. Grodavent at Fort Logan, and Alfred Giles at Fort Sam Houston.⁵⁰

a) Army Post Development, Layout and Styles:

During the second period (1890 - 1917), the Army still lacked a clearly articulated policy for post planning. Design elements from landscape architecture appeared in post layouts during this time, but while Army Regulations of 1904 specified that posts should be aesthetically pleasing, "they did not provide further guidance as to what constituted an attractive post."⁵¹

Between 1890 and 1915, national city planning and design themes were increasingly reflected in

⁴⁷ Catherine C. Lavoie, *Wright Patterson Air Force Base, Brick Officers' Quarters* (Washington: Historic American Engineering Record, HAER NO. OH-103, 1994), 8-21.

⁴⁸ Risch, 582.

⁴⁹ Grashof, 34.

⁵⁰ Goodwin and Associates, 176.

⁵¹ *Ibid.*, 181-182.

Army design efforts as military planners worked to improve living conditions for personnel. Design precedents from the Beaux Arts movement such as the formal site plans and classically-inspired architecture were introduced by civilian architects; some of whom, for the first time, were employed by the Quartermaster Department rather than being hired under contract. At the War College at Washington Barracks (now Ft. McNair in Washington, D.C., and the U.S. Military Academy at West Point, New York, private architectural firms prepared comprehensive site plans which exemplified the Beaux-Arts planning principles such as formal symmetrical building layouts arranged around axes (Figure 14).

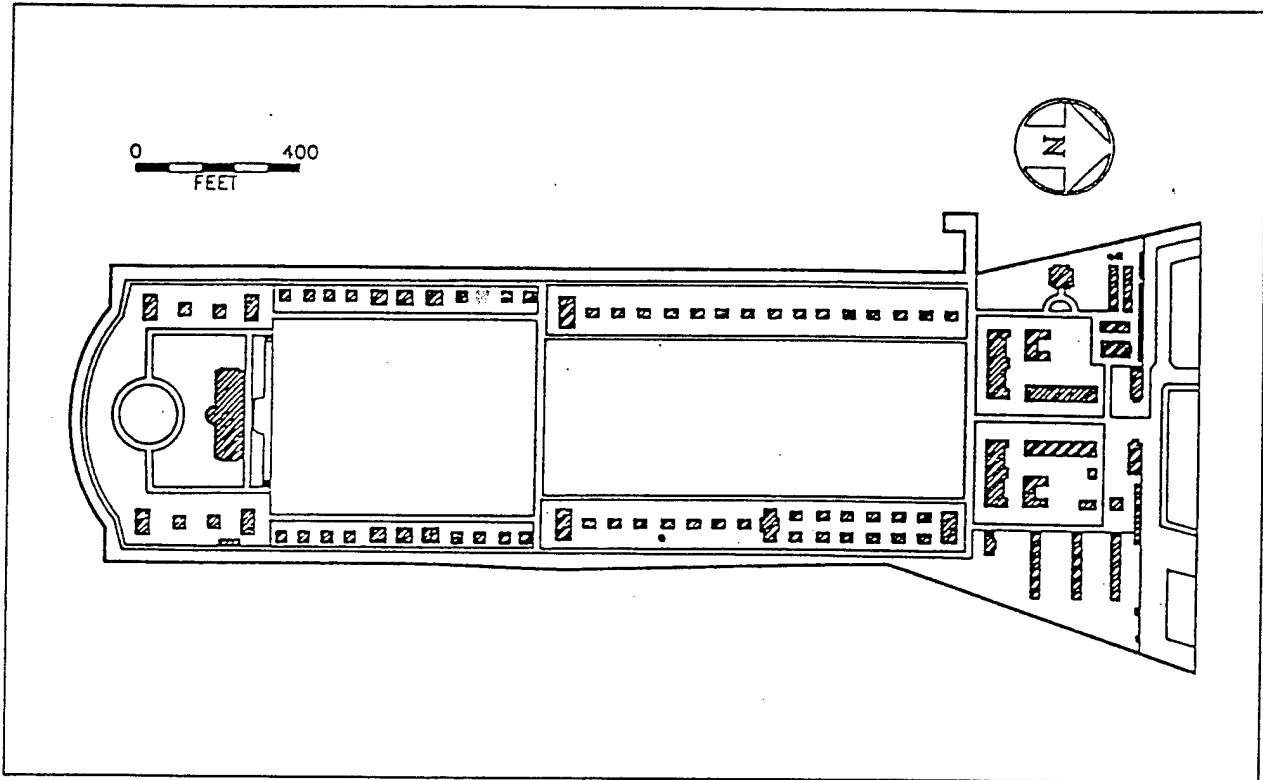

Figure 14--Charles McKim, of McKim, Mead and White, designed the Army War College and Engineers Post.

In 1894, Quartermaster Department designers began using the Colonial Revival and Classical Revival architectural styles for administration buildings and, in the Southwest, a Spanish Colonial Revival style was introduced. The Colonial Revival style was also used in the construction of barracks between 1900 and 1917. The Spanish Colonial Revival was applied in 1911 to barracks which were built at the Presidio in San Francisco, California; Fort Sill in Oklahoma; and Fort Missoula in Montana.

5) THIRD PERIOD OF STANDARDIZATION: 1917 TO 1942

a) World War I:

The numbers of standardized Quartermaster plans proliferated as the nation mobilized for World War I. The Quartermaster Corps, in April 1917, was unprepared for war and for the demands it

brought. Mobilization was of greater urgency for the Quartermaster Corps than for other bureaus and divisions since "it immediately had to transport, clothe, feed, and shelter an expanding Army."⁵² The Quartermaster Corps had, after the Mexican-American War, designed plans for temporary cantonment buildings at regimental, brigade, or division training levels. These plans were made available to department commanders in the field.

The Quartermaster Corps next developed a comprehensive set of interchangeable standard plans for a camp. These drawings are named for the 600 number prefix that the series of drawings carries. Thus, the "600 Series" formed the springboard for later Army designs. Congress also began to supply funds to pay for the Army's design and construction program. While buildings during this period were severely utilitarian and made of wood, the "planning philosophy and logistics necessary in initiating a massive building program" were developed and refined.⁵³ Warfare had taken on a technical aspect, causing the Quartermaster General's office to design buildings for vehicles and tanks as well as for men and animals. Private industry was also recruited to help with the war effort: large construction firms served as architect-engineers and manufacturers' associations orchestrated delivery of supplies to construction sites. It was also a time when architects from the private sector added their design skills to the Army's standardized building plans and layout plans for posts across the country.

When the United States entered World War I in April 1917, the objectives of Army planners became very specific. There was a need for quick, efficient, and, most often, temporary training camps for an expanding Army that would grow to 62 divisions. Centralized planning helped the Army mobilize for war and construction of cantonments became a critical element. The Army's expansion pivoted on an ability to shelter soldiers while they were trained and organized.

With the unfortunate experiences of the Spanish-American War still in mind, senior officers wanted to ensure that the new cantonments contained adequate sanitary facilities and shelters.⁵⁴ The War Department planned to construct 32 training camps by September 1, each capable of sheltering 40,000 soldiers (see **Table 15**).

⁵² Risch, 605.

⁵³ Lavoie, 8-21.

⁵⁴ During the Spanish-American War, the Army used twenty-nine temporary cantonments across the country to shelter large numbers of recruits during training and while awaiting transportation to Cuba. Insufficient attention to water service and sewerage systems and crowded living conditions caused outbreaks of typhoid fever in 90 percent of the volunteer regiments. Of the 14,000 soldiers who contracted typhoid, over 900 died. Source: Goodwin and Associates, 51

TABLE 15--NATIONAL ARMY CANTONMENTS & NATIONAL GUARD CAMPS, 1917⁵⁵

NAME OF CAMP	LOCATION	CAPACITY	COST
National Army Cantonments			
Custer	Battle Creek, Michigan	34,045	8,700,000
Devens	Ayer, Massachusetts	35,288	9,727,000
Dix	Wrightstown, New Jersey	41,309	9,623,067
Dodge	Des Moines, Iowa	40,526	6,815,519
Funston	Fort Riley, Kansas	41,564	8,799,535
Gordon	Atlanta, Georgia	39,796	7,483,002
Grant	Rockford, Illinois	41,309	8,517,233
Jackson	Columbia, South Carolina	42,498	8,731,187
Lee	Petersburg, Virginia	45,512	11,300,000
Lewis	American Lake, Washington	44,685	7,007,235
Meade	Anapolis Junction, Maryland	41,309	10,500,000
Pike	Little Rock, Arkansas	42,347	9,015,565
Sherman	Chillicothe, Ohio	38,393	9,620,075
Travis	Fort Sam Houston, Texas	41,353	6,717,176
Upton	Yaphank, Long Island, New York	40,913	11,128,341
Zachary Taylor	Louisville, Kentucky	43,939	7,041,392
Total		654,786	140,726,472
National Guard Camps			
Beauregard	Alexandria, Louisiana	27,152	2,648,982
Bowie	Fort Worth, Texas	27,152	2,305,402
Cody	Demming, New Mexico	27,152	2,610,443
Doniphan	Fort Sill, Oklahoma	27,152	2,331,802
Fremont	Palo Alto, California	27,152	1,988,729
Greene	Charlotte, North Carolina	27,152	3,246,793
Hancock	Augusta, Georgia	27,152	2,048,571
Kearney	Linda Vista, California	27,152	2,977,088
Logan	Houston, Texas	27,152	1,963,058
McClellan	Anniston, Alabama	27,152	3,258,278
MacArthur	Waco, Texas	27,152	1,974,375
Sevier	Greenville, South Carolina	27,152	1,871,440
Sheridan	Montgomery, Alabama	27,152	1,915,056
Shelby	Hattiesburg, Mississippi	30,762	3,289,825
Wadsworth	Spartansburg, South Carolina	27,152	2,187,327
Wheeler	Macon, Georgia	27,152	2,135,337
Total		438,042	\$38,752,506

Two types of camps were to be built. National Guard units would be housed mostly in tents, with a minimum number of wood support buildings. These camps were to be built in the warmer, southern states. The National Army, which required a longer training period, was to receive temporary wooden shelters in 16 cantonments across the country. In addition to utilities, both types of camps required roads, storehouses, barracks, and administration buildings. Responsibility for these camps was removed from the Quartermaster General and placed in a special "Cantonment Division" later called the "Construction Division" that reported directly to the Secretary of War.⁵⁶ World War I temporary construction is an early example of large-scale

⁵⁵ Fine and Remington, 16.

⁵⁶ Goodwin and Associates, 51.

modular construction which formed the basis for the standardized 700 and 800 series construction plans developed for World War II mobilization.⁵⁷

The Cantonment Division consisted of four general divisions headed by Colonel Issac W. Littell. Among prominent architects to volunteer their services after war had been declared, William A. Starrett, President of Starrett & Van Vleck, Architects of New York City, was asked to head the Committee on Emergency Construction. Littell's board, also known as the Starrett Committee, included many prominent leaders from the design and construction professions. Landscape architect Frederick Law Olmsted, Jr., President of the National Conference on City Planning, was asked to be a member, along with Leonard Metcalf, a leading designer of water and sewerage systems, and two outstanding consulting engineers, George W. Fuller and Asa E. Phillips. In addition, architect and planner George B. Ford and other members of the National Council on City Planning, the American Institute of Architects, and the American Society of Landscape Architects acted as advisors to the Army and applied the principles of city planning to military needs.

Responding to the Army's concern of avoiding the outbreak of sickness that occurred in the Spanish-American War, Olmsted's primary concern was to "properly plan the water supply and sewage arrangements, and certain other features of the general layout for the cantonments of the health of the troops and the general efficiency of the work."⁵⁸ He recommended that site selection and plans for each individual site be done by a city planner, a water and sewer engineer, and an Army officer charged with construction. These design professionals were to "select sites and prepare plans for the individual sites to be entrusted to three experts for each site,"⁵⁹ Olmsted expressed surprise that the Army had no housing or site plans except standardized plans for officer's housing from the 1890s.

Ford and his fellow designers created new national, standardized plans to be adapted to the individual cantonment sites for representative examples of the typical plans (See **Figures 15 through 17**.) Examples of these standardized plans are shown in **Table 16**, indicating the range and level of detail that were provided in these plans. Source: *Manual of the Construction Division of the Army, Section C, Engineering Division, 1918*, Consolidated Supply Co., Printers, 1919). Although civilian planning principles were incorporated into the design process, work went on under wartime emergency conditions and required an emphasis on efficiency and utility rather than aesthetic effect. As proposed, each cantonment was to house an entire division of 35,000 to 45,000 men. Buildings were grouped and organized in a grid-like pattern which separated regiments by military rank and hierarchy. While there were no provisions for housing areas or public parks, this early phase of military base planning was seen as "one of the fruits of the city

⁵⁷ Goodwin, 199.

⁵⁸ National Park Service, Pacific Northwest Region, Cultural Resources Division, *Landscape Development Plan Fort Lewis, Washington: Volume I, Volume I, "Landscape History"* (Jane Merritt, project historian, 1990,2-3: after US Congress, House, Hearings Before the Select Committee on Expenditures in the War Department, Camps, Volume I, 66th Congress, 1st Session, 1919, 1068.

⁵⁹ *Ibid.*, 2-3

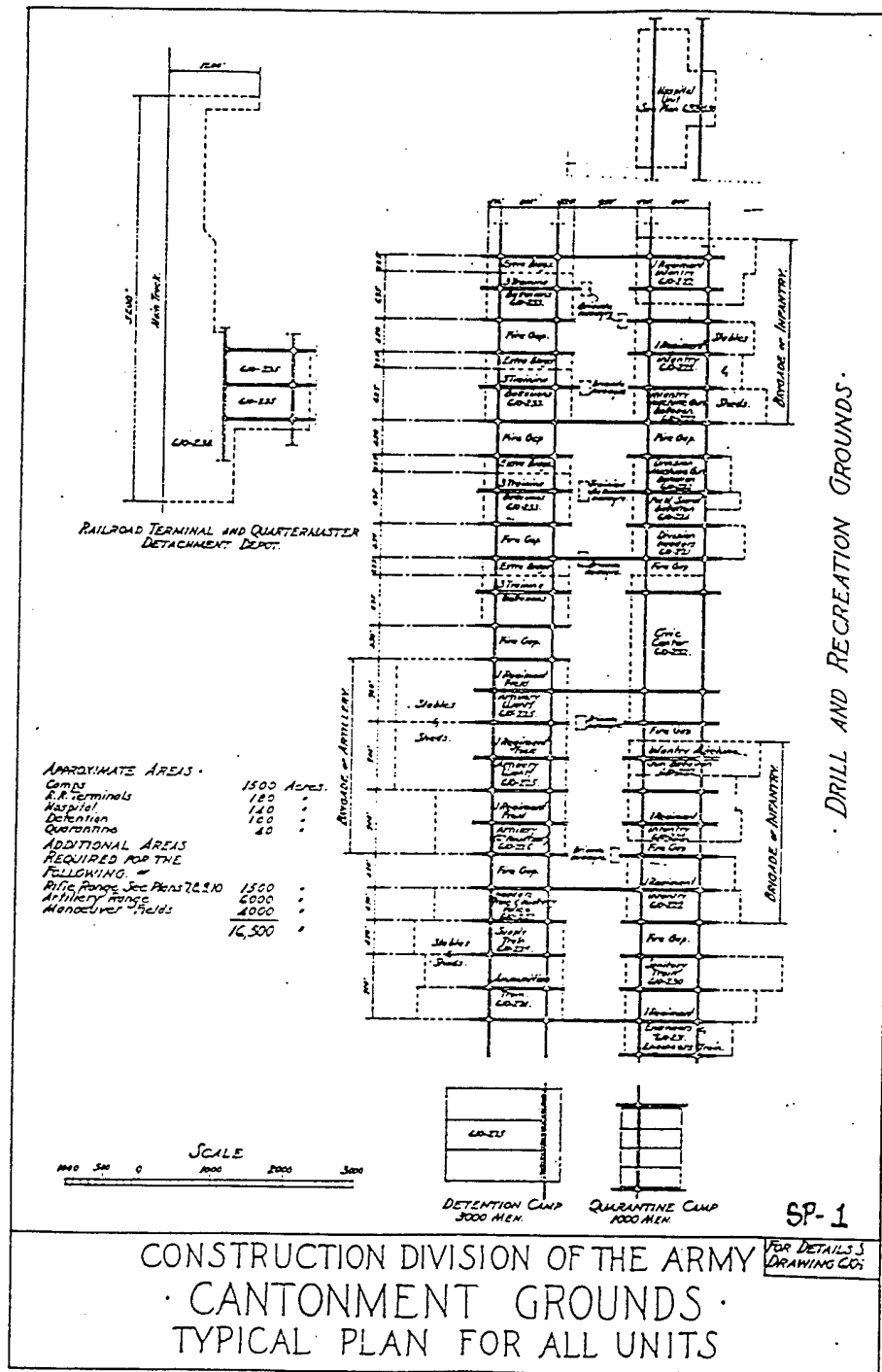

Figure 15. Cantonment Grounds, Typical Plans for All Units. Source: *Manual of the Construction Division of the Army*, Section C, Engineering Division, 1918.

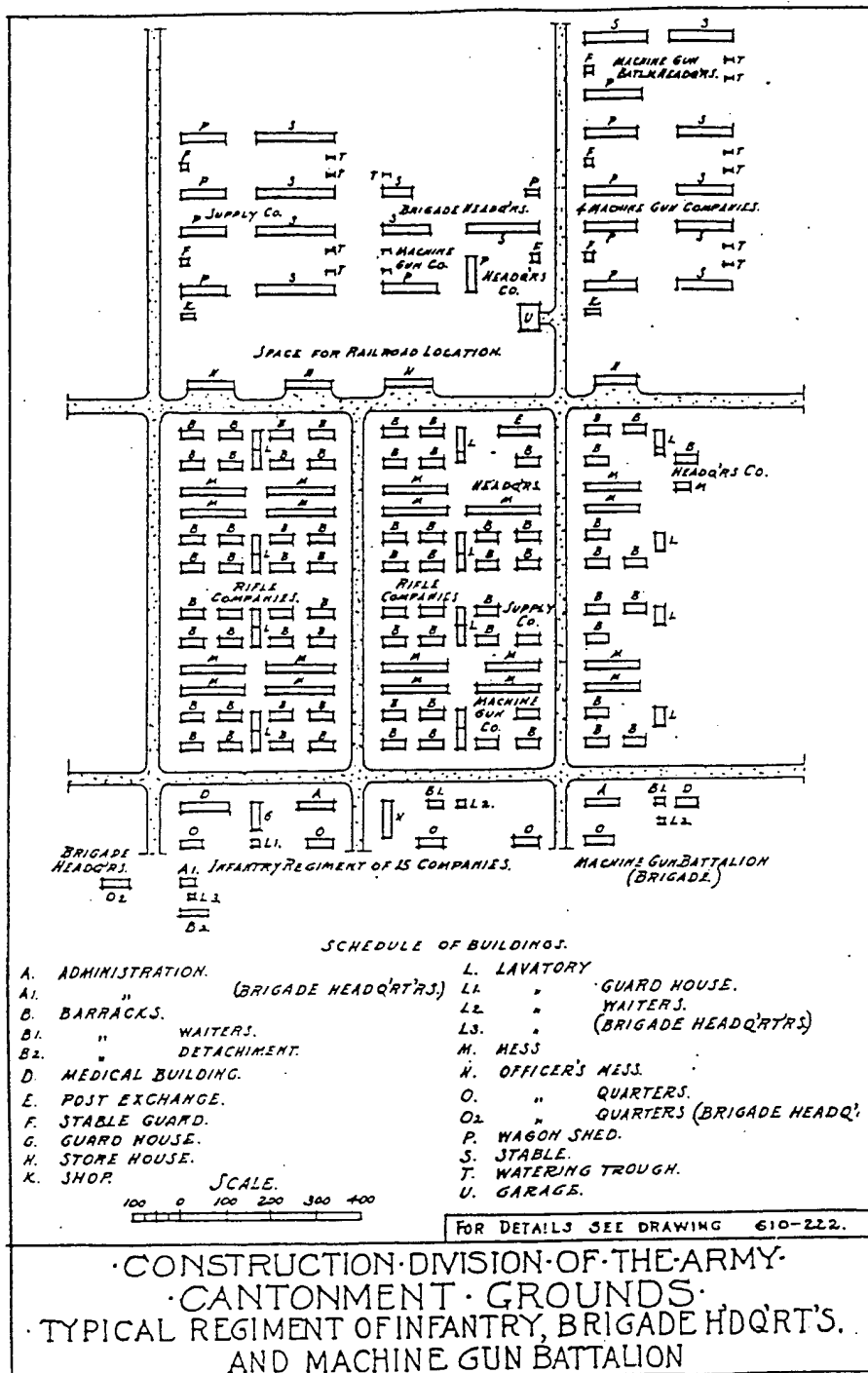

Figure 16. Cantonment Grounds, Typical Regiment of Infantry, Brigade Headquarters, and Machine Gun Battalion. Source: *Manual of the Construction Division of the Army*, Section C, Engineering Division, 1918.

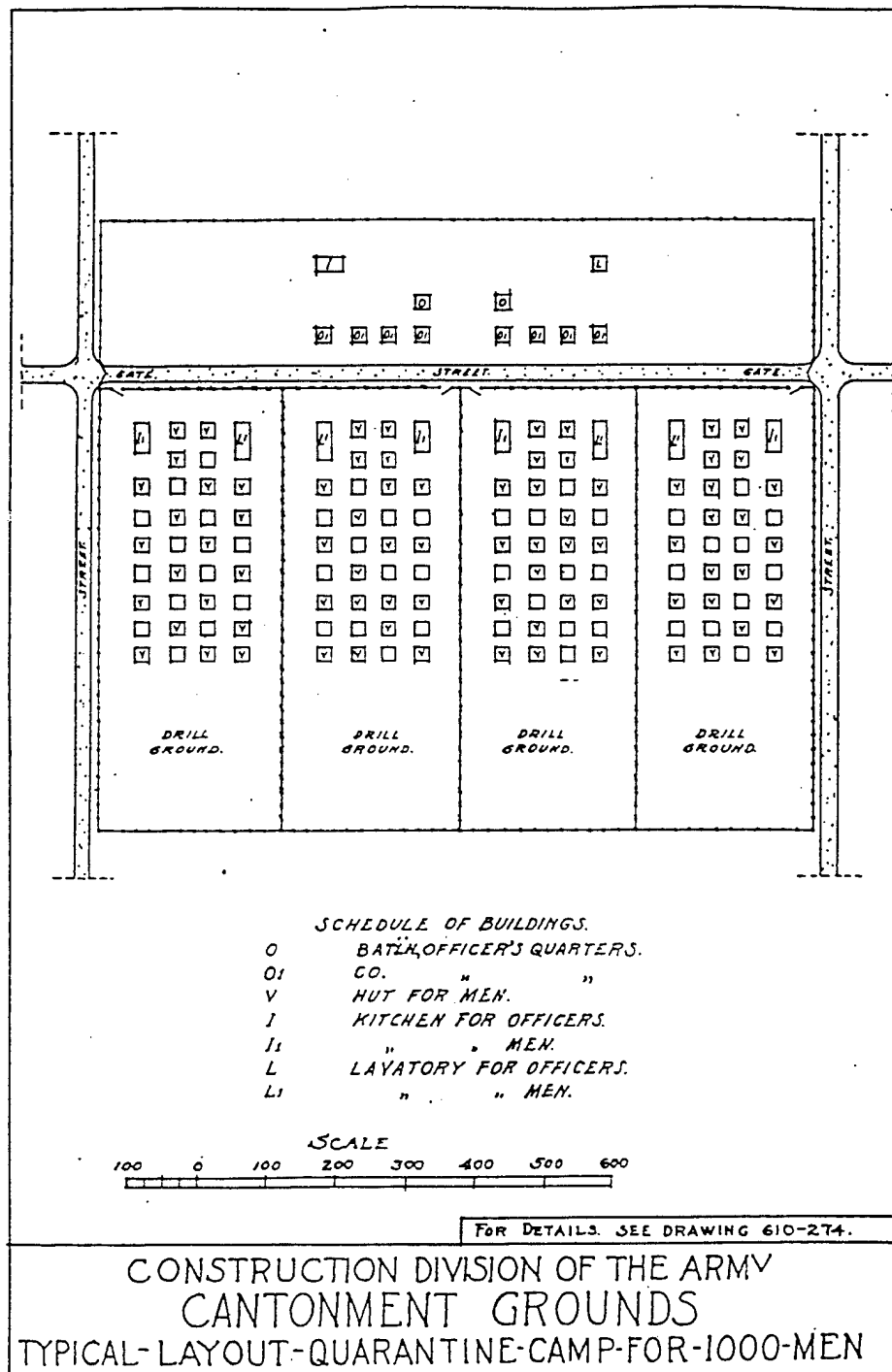

Figure 17. Typical Layout, Quarantine Camp for 1,000 Men. Source: *Manual of the Construction Division of the Army*, Section C, Engineering Division, 1918.

planning movement.”⁶⁰ By July 1917, construction at all 16 Army cantonments was in full swing. The total cost would come to \$140,726,472.

TABLE 16--CANTONMENT GROUNDS: PARTIAL LIST OF TYPICAL LAYOUT PLANS, 1918

STANDARDIZED DRAWING DESCRIPTION	STD DRAWING NO.
Typical Plan for Complete Cantonment	610-240
Typical Division Headquarters	610-221
Typical Reg't of Inf., Brig. HQ and Machine Gun Bat.	610-222
Machine Gun Battalion (Division) 2 Cos. Motorized	610-223
Field Signal Battalion	610-224
Typical Regiment of Light Artillery	610-225
Typical Regiment of Heavy Artillery	610-226
Typical Layout, Camp Center	610-232
Typical Layout, Depot Brigade	610-233
Typical Layout, Railroad Terminal	610-238
Typical Layout Quarantine Camp for 1,000 Men	610-274
Roads: Typical Cross Sections	LA-2 *
Special Plan for Two Balloon Co's and one Aero Squadron	610-281
Typical Buildings: Details-One Story Buildings	SB-1 *
Typical Buildings: Details-Two Story Buildings	SB-2 *
Typical Buildings: 66-Men Barrack	SB-4 *
Typical Buildings: Mess Building	SB-15 *

* These drawing numbers were assigned to these plans for the purposes of this study as the drawings did not carry numbers.

Typical building schedules for cantonments included barracks, mess halls, administration buildings, stables, warehouses, laundries, railroad yards, utility buildings, construction buildings, library, hospitals, post-office, remount station and rifle ranges. With the exception of barracks, structures were temporary one-story, frame buildings. Economical two-story barracks were built instead of single-story ones to conserve ground space and consolidate roads, sewers, and water and electrical lines. Originally, the 600 series building plans developed by the Advisory Architect of the Construction Division of the Quartermaster Corps, were modular buildings of wooden-plank construction with board-and-batten siding. A 1917 revised plan showed barracks of stud construction with horizontal siding. In general, buildings related to infrastructure, including heating plants and electric substations, were constructed of more permanent materials such as brick.

b) Post World War I:

At the end of World War I, the federal government drastically reduced military funding and few new construction projects were initiated. With no funding for maintenance, the cantonment buildings that were lightly-built as temporary structures quickly fell into disrepair. The housing shortage after World War I and lack funds to build new housing and replace deteriorated structures forced the Army to live in substandard quarters. One-third of the enlisted men, 40,000 troops, lived in “unsuitable conditions”⁶¹ Both the press and the Secretary of War’s own Annual

⁶⁰ *Ibid.*, 43.

⁶¹ *Report of the Secretary of War, 1924* (Washington: 1924), 16ff, as quoted in Fine & Remington, 46.

Report of 1924 commented on the unsavory living conditions at Army posts.

In 1926, Congress enacted Public Law 45, authorizing the Secretary to sell all or part of forty-three military reservations and deposit the profits in a "Military Post Construction Fund". These funds were to be used to build permanent barracks, housing for non-commissioned officers, and hospitals. Over seven million dollars were raised and expended by 1927 at posts which the Army felt it should keep but which had severe deficiencies. This unique chance to build permanent housing resulted in a partnership between the Quartermaster Corps and design professionals from private industry who were tasked with developing plans for buildings and posts that would be "a deviation from the set type of military post."⁶²

In the fall of 1927 the Quartermaster surveyed junior officer's wives for suggestions on what type of housing was preferred. They favored single family houses and were not in favor of a central mess. While this seemed more expensive, their response prompted the Army to provide single family housing for both NCOs and officers during this period of permanent construction.⁶³

One outcome of this design and planning period was that the Quartermaster Corps issued new standardized building plans. The new designs were created to respond to regional, environmental and historic conditions. A consistently uniform architectural style was used at each post. Along the east coast, in the midwest and Pacific northwest, the Georgian Colonial Revival style was applied. In the south, western plains, southwest and California, the Spanish Colonial Revival style was used. English Tudor Revival was also used where appropriate, and French Provincial was used in Louisiana and the gulf states.

c) Army Air Corps:

A new, major type of World War I facility was airfields. In January 1917, the Army Signal Corps contracted with noted industrial architect Albert Kahn (1869-1942) to provide plans and specifications for Army airfields. Kahn submitted a set of plans for temporary airfields that the Army built nationwide during World War I. The typical World War I airfield plan consisted of twelve wooden-frame hangars, with accompanying barracks, administration, and support buildings. In general, the hangars were aligned on the flightline. However, the hangars at Brooks AFB, Texas, originally were arranged in a shallow arc. Some of the early airfields included Bolling Army Air Field, Washington, D.C.; Chanute Army Air Field, Illinois; Kelly Army Air Field, Texas; March Army Air Field, California; Maxwell Army Air Field, Alabama; and Selfridge Army Air Field, Michigan.⁶⁴

New units of the Army Air Corps also became priority sites for new construction. The Air Corps Act of 1926 allowed for a five-year expansion program "to recruit additional men and purchase new aircraft."⁶⁵ Langley Field, Virginia, and Rockwell Field, California (under construction)

⁶² 1st Lt. Howard B. Nurse, "The Planning of Army Posts" in *The Quartermaster Review* (September-October, 1928), 15.

⁶³ Lt. Col. John S. Chambers, "Quarters for the Army", *The Quartermaster Review*, March-April, 1928, 25.

⁶⁴ Goodwin & Associates, 200.

⁶⁵ *Ibid.*, 51.

were the Air Corps only permanent bases in 1925. New bases were designed to fly, maintain and test aircraft. Funds for the construction of Army Air Corps bases were included in Congressional appropriations for Army posts and their construction was administered by the Quartermaster Corps. (See Table 17)

TABLE 17--DATES OF MAJOR CONSTRUCTION AT SELECTED AIR CORPS BASES⁶⁶

1933-1938	1939	1940	1941	1942
Edwards 1933	McDill	Davis	Castle	Altus
Eglin 1933	Westover	Elmendorf	Columbia	Beale
Hickam 1935		Goodfellow	George	Bergstrom
Lowry 1937		Gunter	Nellis	Blytheville
McDill 1937		Hill	Griffith	Cannon
McGuire 1937		Myrtle Beach	Hanscom	Carswell
McChord 1938		Patrick	Keesler	Charleston
		Ladd	Kirtland	Dover
			Lackland	Dyass
			Luke	England
			Moody	Fairchild
			Reese	Grissom
			Robb	Holloman
			Shepherd	Homestead
			Tinker	Laughlin
			Tyndall	Malmstrom
			Vance	Norton
			Williams	Peterson
				Travis
				Whiteman
Bases	7	2	8	18
				20

Permanent Air Corps fields built during the early 1930s were usually planned with bilateral symmetry. The Quartermaster Corps developed a plan in 1926 for March Field, California, that was a one-mile square with the runways laid out on the square's diagonal axis. The same design was used at Barksdale AFB, Louisiana. At Randolph AFB, Texas, Air Corps officer Harold Clark laid out a complex design that separated operational areas into formal geometric patterns. Square in plan, the flightlines defined two sides. A central axis contained "the administration building, commander's quarters, officers club, and cadet school."⁶⁷

In the later part of the 1930s, aircraft had evolved to higher performance levels. They were capable of faster speeds and carrying greater loads. Airfield design changed to accommodate these changes. Greater length was added to runways and intersecting runways were introduced to take advantage of prevailing winds. Also, runway surfaces were improved to bear the weight

⁶⁶ Mueller, Robert *Active Air Force Bases Within the United States of America, 1989*, as quoted in memo from Burgess, HQ AMC/CEVP to Foxall, TCX EN-DB-AC Seattle District, May 20, 1994.

⁶⁷ Thomas A. Manning, "Origins of Randolph AFB" (MSS, Air Training Command. History Office, Randolph AFB, Texas, 1987), as quoted in Goodwin, R. Christopher and Associates, *National Historic Context for Department of Defense Installations, 1790-1940; Volume I* (Baltimore, MD: United States Army Corps of Engineers, 1995), 50.

George B. Ford "New Army Posts for Old," *The Quartermaster Review* (September-October, 1928): 14-16.

of the newer, improved aircraft. The sited of barracks and administration buildings were shifted to bring work and living spaces closer to the aircraft. Chanute AFB, with its "A" shaped pattern of runways is reminiscent of this design.

Until the end of 1940, site selection for new Army Air Corps bases was done by boards of officers. Most members were appointed by General Henry H. Arnold, chief of the Air Corps, and included airmen, General Staff and Engineer officers, often with no representative from the Quartermaster Corps. Finding few perfect sites, the boards made little progress. Quartermaster planners, meanwhile, examined existing posts and proposed \$34 million worth of new construction in the continental United States, Panama, and Hawaii. Included were "barracks, quarters, shops and warehouses, storage for gasoline and oil, runways, aprons, hardstands, hangars, laboratories, hospitals and schools."⁶⁸

Working with the Air Corps was difficult, in part because of the technical requirements of specialized buildings. The Air Corps staff also presented challenges. General Arnold would not approve Quartermaster layouts containing standardized designs for barracks. Instead, he proposed placing new, prefabricated buildings among permanent buildings and tapping into existing utilities. This raised a concern among Quartermaster designers about creating fire hazards. In July 1939, both sides compromised. The Air Corps agreed to accept mobilization-type buildings and the Quartermaster offered to let the prefab industry compete for housing contracts. The problem of site selections was resolved in July 1940, when three boards were appointed by the General Staff with representatives from the Quartermaster Corps, the Air Corps and the General Staff. The boards hit upon the idea of developing civil airports and received enthusiastic receptions at hundreds of cities. This strategy also eliminated the costly option of building entirely new airfields.

Work continued, but a few months later several projects were in trouble. Air Corps changes to some requirements caused delays. The Quartermaster's centralized control also contributed to delays, and the prefab companies were being underbid. In November 1940, the Air Corps construction program was transferred to the Corps of Engineers. Eighty-one projects, valued at \$200,000,000 "lifted a sizable burden from the shoulders of The Quartermaster General."⁶⁹

d) The Construction Program:

In 1920, the Construction Service of the Quartermaster Corps was created, separating it from the other duties of the Quartermaster Corps where it had been the organized as the Construction Division. The centralized organization of the Construction Service required Construction Quartermasters to report to the Quartermaster General instead of to post commanders. But this arrangement ended when the Secretary of War decreed "No permanent construction will be undertaken where permanent construction can be postponed and only such repairs and temporary construction necessary will be considered."⁷⁰

⁶⁸ Fine and Remington, 95.

⁶⁹ Ibid., 267.

⁷⁰ Ibid., 44.

Between 1926 and 1930, Congress appropriated approximately \$126 million for the Construction Service.⁷¹ Using funds from the National Industrial Recovery Act, the Quartermaster Corps continued work between 1929 and 1932 at a much-reduced pace during the Depression. (See **Table 18**.) Standardized plans were prepared for over 1,600 buildings at sixty-five posts. During this time, construction projects for twenty-two Army Air Corps bases were started.

**TABLE 18--INSTALLATIONS RECEIVING MAJOR CONSTRUCTION PROJECTS
UNDER THE NATIONAL INDUSTRIAL RECOVERY ACT**

Maxwell Field, AL	Ft. Belvoir, VA
Ft. Lewis, WA	Langley Field, VA
Randolf Field, TX	Ft. Humphreys, VA
Albrook Field, Canal Zone	March Field, CA
Wheeler Field, HI	Aberdeen Proving Ground, MD
Hamilton Field, CA	Bolling Field, Washington DC
Barksdale Field, LA	Ft. Clayton, Canal Zone
Ft. Monmouth, NJ	Ft. Sam Houston, TX
Ft. George G. Meade, MD	Ft. McClellan, AL
Edgewood Arsenal, MD	Ft Bliss, TX
Ft. Bragg, NC	Walter Reed Hospital, MD

From 1934 to 1936, funding declined to \$14 million (\$10 million was for buildings at West Point and Hickam Field in Hawaii). Matters did not improve as the Army started to grow in preparation for World War II. In 1936, the Army's enlisted strength was 153,000 men, "housed in stables, attics, and gymnasiums."⁷² Continuing international tensions contributed to authorizations for a larger Army, 165,000 men in 1937 and 170,000 men in 1938, but one faced with practically no construction funding since 1933.

Finally, in 1937, Congress authorized almost \$26 million to be spent at forty-six posts, followed by \$12 million in June of 1938. Ten days later, President Roosevelt gave the Construction Division \$65 million. When war broke out in Europe on September 1, 1939, the President issued an Executive Order to expand the Army from 210,000 men to 227,000 and the National Guard from 220,000 to 235,000 men. The War Department drew up plans for a defense construction program estimated "to cost between \$850 million and \$1 billion" but these plans languished unfunded by Congress.⁷³ The 700 Series, 800 Series, Modified Theater-of-Operations (T.O.) Series, and the T.O. 700 Series all evolved from the 600 Series designs created in World War I. The T.O. series were "minimalist" structures and did not survive into the postwar period.

Hard pressed now and under fire for being too centralized to work efficiently, the question of removing construction from the Quartermaster Corps came up repeatedly. In the face of this opposition, the Quartermaster Corps developed standardized plans for:

barracks for 25, 45 and 63 men, mess halls with seating capacities of up to 1,000, hospitals ranging in size from 25 to 2,000 beds, dispensaries, guard houses, cold storage plants, fire

⁷¹ Ibid., 50.

⁷² Ibid., 54.

⁷³ Ibid., 103.

stations, control towers, telephone exchanges freight terminals, and numerous other structures. Specifications were available for everything from flagpoles to 5,000-gallon gasoline storage and distribution systems.⁷⁴

These plans were badly needed. Before being sent overseas, G.I.s needed housing and training. A gigantic construction program began in the fall of 1940. By November of 1944, the Army had housing for 6 million troops in the continental U.S. A small number lived in tents but most lived, trained and worked in more than 30,000 "temporary" wood-frame buildings. Only 270,000 of the 6 million troops "were lodged in buildings labeled 'permanent.'"⁷⁵

Planners designing post layouts also considered and investigated climate, topography, geology, soil conditions, labor, transportation, real estate and utilities at each potential site. Survey teams probed sites for information on "terrain, subsurface rock, natural drainage, flood levels, vegetation, real estate values, availability of adjacent tracts, location of railways and highways, the size of the local labor force, the amount of housing in the area... [w]ater supply, sewerage, electrical power and fuel." Lists of potential sites were drawn up, boards of officers investigated each site, and their recommendations were forwarded to the War Department.⁷⁶ General Brehon B. Somervell, chief of the Construction Division, anticipated that "we won't have to build these camps on places ...where we have to blast out entire sewer and water lines for a population of 30,000 people."⁷⁷

In May 1941, over 150 sites had been investigated for the new camps. Reports were reviewed by the Operations and Training Division, the Supply Division, the Surgeon General and, finally, the Quartermaster General. Twenty-three sites were selected for planning purposes. Architect-engineers were put to work by the Quartermaster Corps in camp planning and included firms like J. B. McCreary; Charles T. Main; Black & Veatch; and Leeds, Hill, Barnard and Jewett. Working under fixed-fee contracts, much of the planning for the camps was done in 90 days.

The ideal camp included tightly designed regimental areas; "short roads and utilities lines; a centrally located storage depot; and an unusually good concept for landscaping and site development."⁷⁸ The camps were in fact small cities. Camp Edwards, California, had 1,400 buildings. Unseen but essential plans were developed for water, gas and electricity lines; sewage lines and disposal plants; and streets, roads and railroads. The Quartermaster Corps overcame problems with scarcity of building materials, located sixty million dollars worth of construction equipment, found skilled labor to build the camps, settled strikes over wages and hours, and

⁷⁴ Ibid., 168-69.

⁷⁵ Kriv, Arlene R. (Editor), *World War II and the U.S. Army Mobilization Program: A History of 700 and 800 series Cantonment Construction* (Washington, D.C.: Historic American Building Survey/Historic American Engineering Record, National Park Service for Legacy Resources Management Program, U.S. Department of Defense, 1993), 3.

⁷⁶ These boards consisted of officers appointed by the corps area commander and included a Constructing Quartermaster from the Quartermaster Corps, a Medical officer, and Engineer officer and an officer representing the local army commander.

⁷⁷ As quoted in Fine & Remington, 345.

⁷⁸ Fine & Remington, 211.

developed assembly line techniques for clearing land and prefabricating parts to erect buildings in record time. Constructing Quartermasters, located at individual job sites, developed streamlined auditing techniques that took into account the contractor's needs for reimbursement of funds to keep going.

But by November 1940, time was running out. The Quartermaster Corps was stretched to its organizational limits. Unrealistic planning for mobilization and indecision on whether the Army's construction mission properly belonged to the Quartermaster or to the Engineers "produced grave concern within the War Department."⁷⁹ Construction continued, but there were delays in "project after project" and the Quartermaster Corps came in for criticism in the press and official dissatisfaction with progress.

The Quartermaster Corps was busy in 1941. The 700 series plans were reviewed and improved by requiring heavier framing, better roofing and adding door and window screens. Deleted from the plans (resulting in savings) were skirting, "acqua medias" above windows, and termite shields. Even as work on the 700 series was being completed, a new series was coming out.

The new 800 series, completed in the spring of 1941, were quite different from the 700 series they replaced. The new barracks were larger, resulting in a reduced number of buildings in smaller cantonments, and required the construction of fewer miles of roads and shorter utility lines. Most Army companies fit badly into four of the 700 series barracks, but neatly into three of the new 800 series. This new series received both praise and criticism. The barracks were custom-sized; they were better built and more livable and although they cost more, fewer were needed so installations could be built for about the same cost as 700 series buildings. Critics felt the improved buildings were "semi-permanent" rather than temporary, that too much high grade material and extra long lengths of lumber were called for, and that the positive changes could have been incorporated into the 700 series. When the Quartermaster Corps compromised by allowing shorter lengths of material for use outside of earthquake and hurricane zones, the General Staff approved the 800 series.

A Quartermaster Corps program to test building materials recommended that hospitals be two-story and made of fire-resistant materials; that portable prefabricated huts replace tents, and that "sturdier" materials like masonry, cinder block, and tile be used in addition to wood. Approval to deviate from standardized plans came in April 1941, and although construction remained predominately wood, designs using other materials began to appear.

The Quartermaster Corps also began stockpiling lumber in anticipation of increased construction. Over 265 million board feet were purchased in February for delivery in May, thereby assuring enough materials were on hand to avoid shortages.

In September of 1941, identical bills were introduced in both houses of Congress proposing that all Army construction work be assigned to the Corps of Engineers. On December 1, the President signed the House measure into law, just days before the attack on Pearl Harbor.

⁷⁹ Ibid., 240.

e) Army Post Development, Layout, and Architectural Styles:

This report focuses on Quartermaster Corps standardized buildings. However, Quartermaster Corps standardized *landscape features* should also be identified, documented and evaluated during historic resource assessments.⁸⁰

By the third period of standardization, the Quartermaster Corps had launched a more comprehensive plan for Army post development. Post layout until this era had followed grid-like patterns and the buildings "were arranged in monotonous rows close together, with little privacy ...utterly unattractive."⁸¹ By World War I, however, the Army began providing standards and guidelines for installation site plans. These guidelines were based on national design trends in city and community planning. City planners with national reputations served as advisors on how to lay out the posts.

Ideally, the standardized site plan was a U-shaped arrangement of buildings and structural units that covered up to six square miles. The base of the U was to be accessible to transportation routes and communication lines. The legs of the U were composed of barracks, officer's quarters, and other buildings. The space between the legs was left open to serve as a parade ground, and varied in size from one thousand to twelve hundred feet wide.

Placement and organization of the road system was intentionally used to establish the separation of rank and the separation of functions within the cantonment. The main street through the post was a broad avenue about 100 feet wide and more than 2 and 1/2 miles in length, separating the officers quarters from the soldiers barracks. An Army Major, working with troops at Camp Lee, Virginia, described the typical encampment: "Branch streets, running at right angles to [the main street] separate the battalions of the division, wider avenues the regiments, these latter serving as 'firebreaks.' These battalion and regimental streets are about 200 yards long, and form in

⁸⁰ A historic landscape is defined as "a geographic area, including both cultural and natural resources, associated with a historic event, activity, or person, or exhibiting other cultural or aesthetic values."⁸⁰ There are four types of historic landscapes; *designed, vernacular, sites, and ethnographic landscapes.*

Historic landscapes and/or landscape features associated with the Quartermaster Corps planning and design efforts are considered *historic designed landscapes.* A historic designed landscape is defined as "a landscape that was consciously designed or laid out by a landscape architect, planner, architect, master gardener, or horticulturist according to design principles, or an amateur gardener working in a recognized style or tradition. The landscape may be associated with a significant person(s), trend, or event in landscape architecture; or illustrate an important development in the theory and practice of landscape architecture."

For more information on documenting and evaluating historic landscapes see: *National Register Bulletin 18: How to Evaluate and Nominate Designed Historic Landscapes*; and *National Register Bulletin 30: Guidelines for Evaluating and Documenting Rural Historic Landscapes*, National Park Service, Interagency Resources Division, 1987; *Guidelines for the Treatment of Historic Landscapes*, National Park Service, Preservation Assistance Division, 1992; and *Preservation Brief 36: Protecting Cultural Landscapes: Planning, Treatment and Management of Historic Landscapes*, Charles Birnbaum, National Park Service, Preservation Assistance Division, 1994.

A number of "character-defining features" are used to document and assess the character of a historic landscape. These include overall organization, response to natural features, land uses and activities, circulation features and systems, vegetation, structures, and small-scale features.

⁸¹ George B. Ford, "New Army Posts for Old" *The Quartermaster Review* (November-December, 1929) 19.

themselves compact social areas.”⁸² Character-defining landscape features depicted on World War I standardized plans include overall organization and land use (standardized site plans), circulation features (roads, railroads), and building clusters.

In his 1927 *Annual Report to the War Department*, Major General B.F. Cheatham (Quartermaster General 1926-1930) presented a wide directive for improvement of the Army’s permanent military bases. Cheatham’s goal was to combine military tradition with the design concepts of city planning and landscape architecture. His primary concern was to maintain the unity of regimental commands through a quadrangle barracks formation, arranging the officers quarters, barracks and other military facilities according to regimental units. This arrangement concentrated the barracks so they could be easily controlled while giving enlisted men as much privacy as possible.

To implement these goals, Cheatham and the Construction Division launched a comprehensive plan for Army post development during the late 1920s and 1930s.⁸³ To oversee the program, the Construction Division put together an influential group of architects, engineers, planners, designers, and landscape architects. Included was architect and planner, George B. Ford, a member of the W.W.I. civilian design committee, hired in 1929 to review installation plans. Ford’s used efficient, simple plans and combined them with planning concepts used in the City Beautiful and Garden City movements. The goal of the professional team “was to develop efficient, cohesive, and pleasant environments within reasonable expenditures.”⁸⁴

Writing in *The Quartermaster Review*, Ford addressed the matter of designing for military posts. While the Army’s efficiency was praiseworthy, he felt it was “a well-known tradition of the Army in the past that whereas Army buildings and layout must be practical, nevertheless they should look military. There seemed to be a feeling that any building or layout that was not foursquare and austere was effeminate and unworthy of the Army.”⁸⁵ Pleasant environments could be created using vistas and irregular lines. Examples of these environments can be noted in the layouts of Fort Lewis in Washington and Camp Devens in Massachusetts.

In Ford’s 1930 article, “A Better Looking City”, he recommended architectural continuity within residential neighborhoods, at the same time warning against the monotony of subdivisions. Ford advocated the use of curvilinear streets, open spaces for playgrounds, large avenues and streets, and abundant planting.⁸⁶ These city planning influences can still be seen in many of the permanent bases built during this period where officers residential areas contained large yards, curvilinear streets, and large neighborhood open spaces.⁸⁷ (See **Figure 18.**)

⁸² Ibid., 5.

⁸³ Swanberg, 78; Fine and Remington, 48.

⁸⁴ Goodwin, 207.

⁸⁵ Ford, 14-16.

⁸⁶ Ford, 71.

⁸⁷ Other examples include but are not limited to the neighborhood of Broadmoore at Fort Lewis, Washington; Aberdeen Proving Ground, Maryland; Maxwell Air Force Base, Alabama; the brick officer’s quarters at Wright Patterson Air Force Base, Ohio; Fort Monroe, Virginia; Bolling Air Force Base, Maryland; and Fort Benning, Georgia.

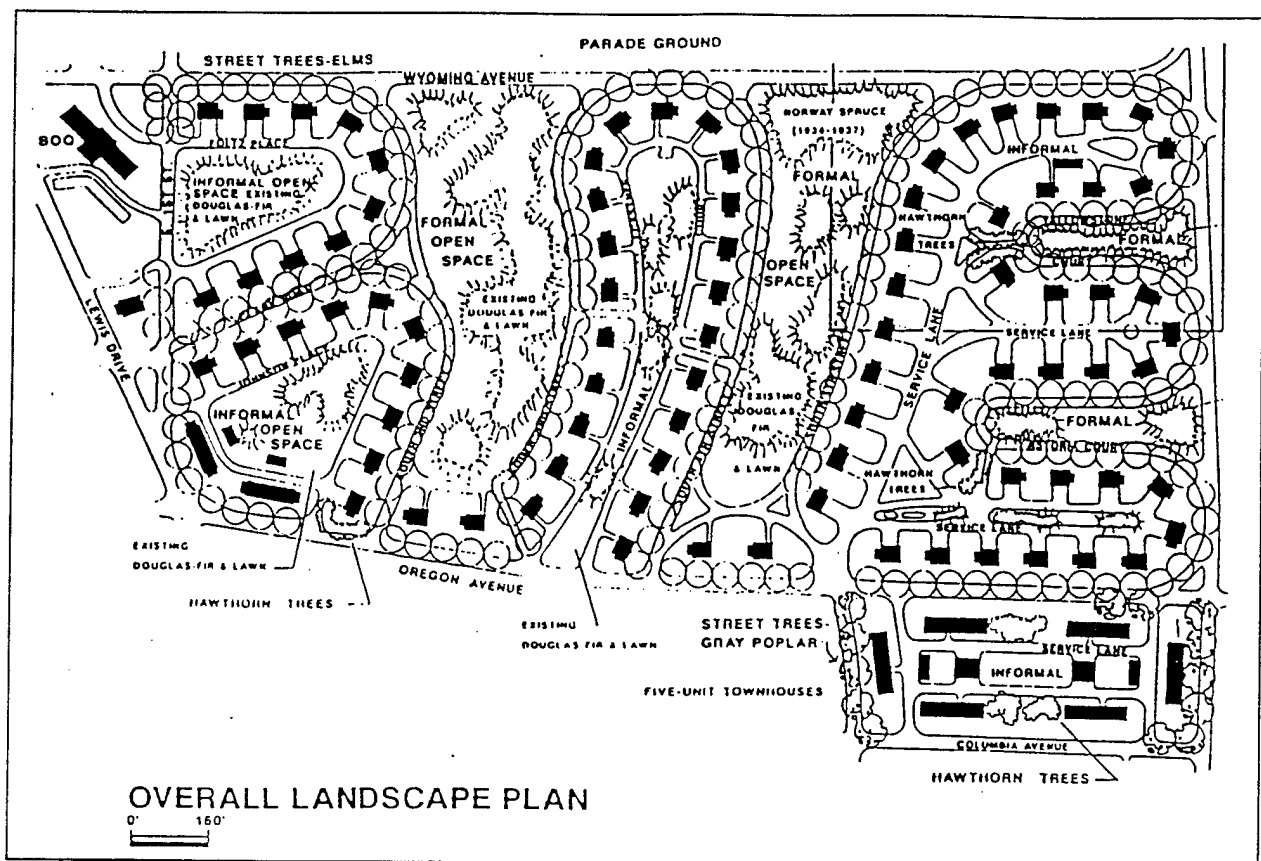

Figure 18--Broadmoor neighborhood of Fort Lewis, Washington showing layout of curvilinear streets and large open areas.

First Lieutenant Howard B. Nurse, of the Quartermaster Corps, compared the planning of Army posts to the new field of city planning. The goal of planners and developers was to achieve healthy conditions, scientific training of troops, and provide “the means of social intercourse.” To achieve these ends, Nurse recommended a comprehensive plan for installation growth.⁸⁸ Like Ford, Nurse advocated using topography in the design and layout of streets, avoiding straight lines, especially in residential areas. Although he conceded that many older posts had a charming appearance that increased with time, he believed that installation planning depended upon the systematic application of city planning principles.

The consistent application of master planning concepts such as functional, hierarchical arrangements of buildings and circulation systems (roads and sidewalks), incorporation of community areas and open space, standardized building setbacks, and the design of curvilinear roads and orientation of buildings to compliment existing topography, allowed the ordered development of posts. While parade grounds were no longer always the central feature of the

⁸⁸ He further suggested planners should consider five principles: (1) unity, or the coordination of the various plans; (2) consonance in design of recurring patterns; (3) natural beauty, even while accepting natural differences in designs; (4) balance, usually along an axis; and (5) radiation, whereby parts of a community radiate from the center and return. He found parallels for these principles in examples of natural design, and even compared the military community to a living organism.

site, as they were for earlier posts, they still served as important organizing features in the overall site plan. Some posts contained multiple parade grounds, using individual parade grounds as central features for different functional areas which were linked by boulevards and vistas.

Approved by Congress in 1926, Public Law No. 45 opened the way for new construction on Army posts. As a result of this activity, standardized plans using two Colonial Revival styles began showing up in Quartermaster designs in the 1930s. These were Georgian Colonial Revival, used on the northern Atlantic seaboard and across to the Northwest, and Spanish Colonial Revival, used in the warm Southeast and Southwest regions. Neighborhoods of NCO family housing were developed during the years between World War I and II using suburban cottage and bungalow style buildings.

f) Landscape Plantings:

Landscaping at permanent bases was addressed as part of the comprehensive design process. The Quartermaster Report of 1927 suggested planting trees and shrubs to “harmonize with the general scheme for each post.” The Department of Agriculture furnished information to the War Department on plant materials while some post commanders established nurseries for growing plants, shrubbery and trees. Ford, in his role as advisor, thought that the layout and landscape of the new posts “with all its carefully disposed trees, lawns and shrubbery, will form a beautiful pattern most attractive in color as well as in form. The post itself will have all the charm that the best modern subdivisions have and ...should function with great efficiency”⁸⁹

By 1931, the Construction Division of the Quartermaster Corps had established a national design criteria for landscaping military posts which could be applied to individual sites. The Landscape Unit acted as a clearinghouse of information for bases that wished to improve their grounds: “Aids for the development and maintenance of the beautification of the Post have been created. Nurseries have been encouraged in the Posts, where the better plant material suitable for that locality may be grown. Lists of such plants and specifications for the care and planting of these are available, on request.”⁹⁰

Besides making plant material available, the Landscape Unit also advocated general planting design principles such as: the use of trees and shrubs to screen objectionable views; frame interesting views and accentuate points of interest; separate functional areas; moderate harsh environmental conditions through soil erosion control and planting trees for shade; and generally “create a pleasing and livable atmosphere outdoors”⁹¹

In 1933-34, the Landscape Unit prepared standardized landscape plans for bases titled “Typical Landscape Planting”. These standardized planting plans were developed for several standardized building plans including:

⁸⁹ Ford, 20.

⁹⁰ E. Mack Hallauer, “Landscaping the Army Post.” *The Quartermaster Review* (July-August 1939), 30.

⁹¹ *Ibid.*, pp. 30.

Figure 19--Company Officers' Quarters and Double N.C.O. Quarters;
Figure 20--Headquarters Administration Building, Bachelor Officers' Quarters and Barracks;
Figure 21--Theater, Chapel and Hospital; and

These standardized plans established general design principles for a popular 1920s and 1930s planting style, foundation planting. The plans were prepared so that plant material could be adapted to different regions of the country.

The necessity for landscaping military posts was justified on the basis of instilling civic pride and increasing morale among the enlisted men.⁹² However, the quantity of materials available for the actual plantings, due to Army cost regulations, tended to be small. And, in many cases, landscaping was not installed until years after initial construction, as Commanding Generals found time and money for grounds improvement projects.

g) Site Planning

In 1941, new site plans and post layouts were developed as the 700 series gave way to the new 800 series plans. Leon H. Zach, a Harvard-trained landscape architect and associate of the Olmsted Brothers, took charge of site planning. He sought efficiency and usefulness for the mobilization camps, but economy of construction drove him to "consolidate functions and compact areas to the utmost."⁹³ He reduced the amount of roads in divisional cantonments by 44 percent and graded areas by another 25 percent. At airfields he effected a 51.6 percent reduction in roads, "and similar economies in water and sewer lines."⁹⁴ (See **Figure 22.**)

⁹² Ibid., pp. 31.

⁹³ Leon Zach, "Site Planning of Cantonment and Community Housing," *Civil Engineering*, XV, No. 8 (August 1945), 363-65.

⁹⁴ Fine and Remington, 353.

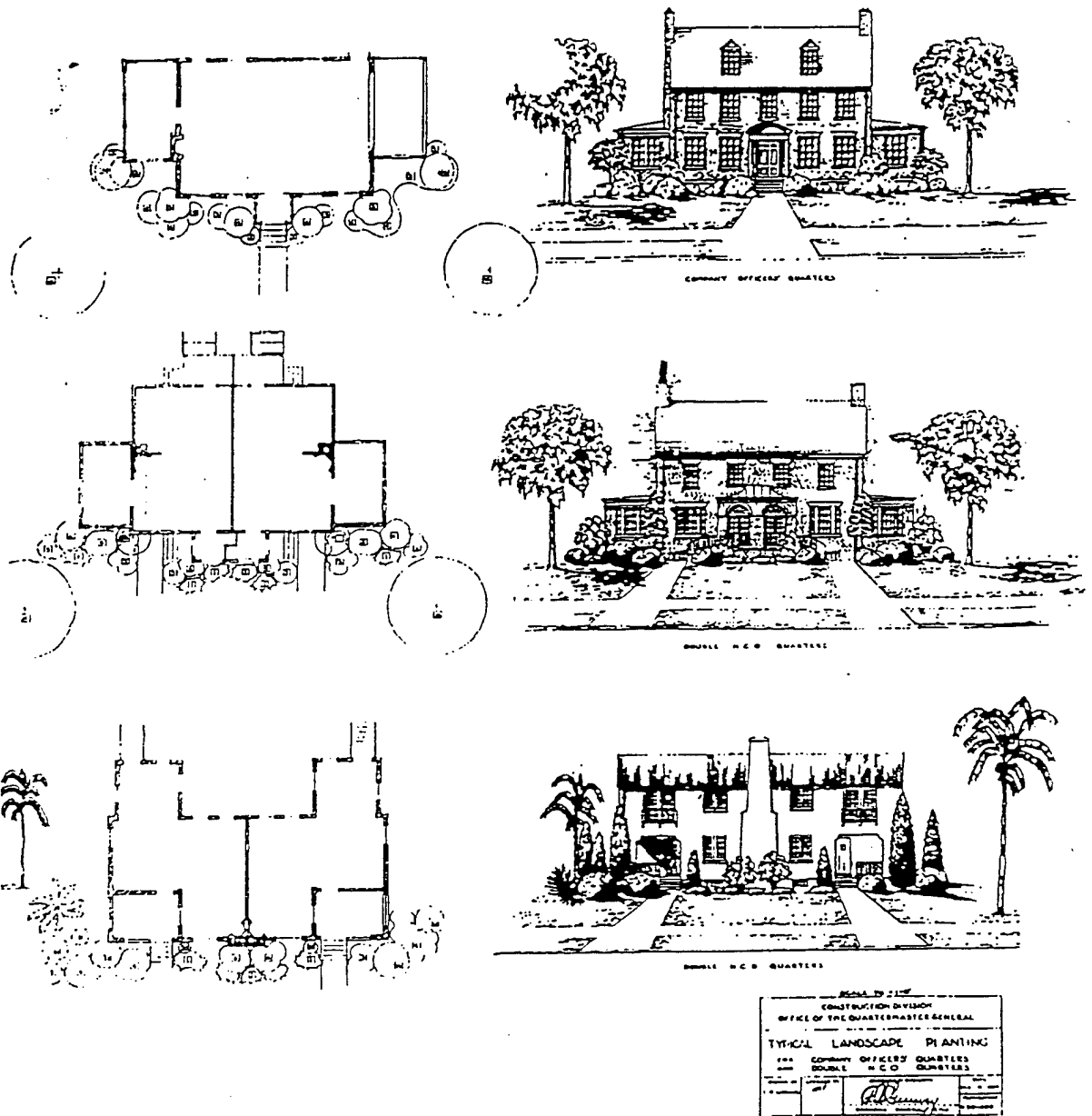
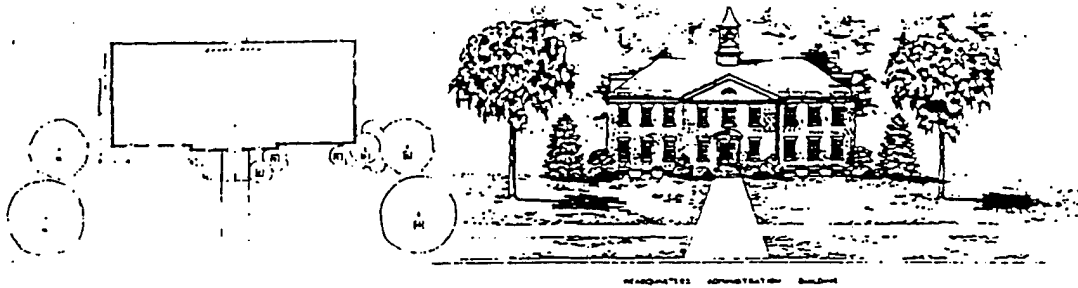
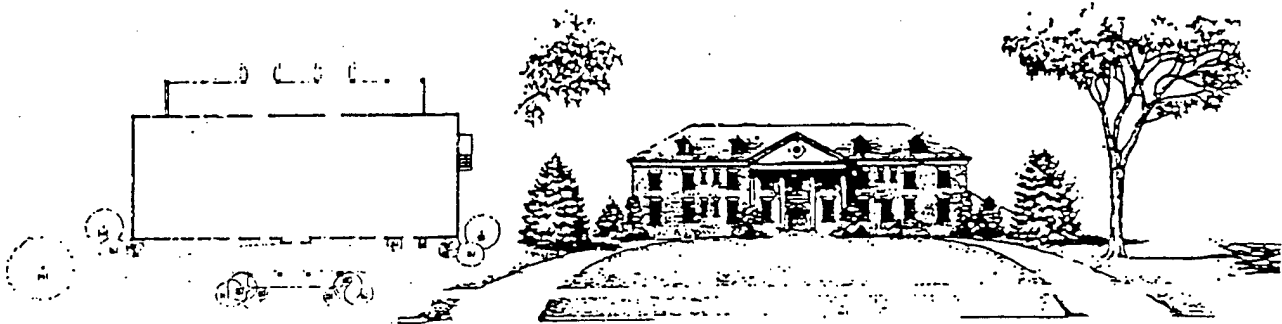

Figure 19. Typical Landscape Planting Plans for: Company Officers' Quarters and Double N.C.O. Quarters.
 Source: Office of History, Headquarters, U.S. Army Corps of Engineers, Alexandria, VA.



HEADQUARTERS ADMINISTRATION BUILDING



BACHELOR OFFICERS' QUARTERS



BARRACKS BUILDING

SCALE 1/4" = 1'-0"	
CONSTRUCTION DIVISION OFFICE OF THE QUARTERMASTER GENERAL	
TYPICAL LANDSCAPE PLANTING HEADQUARTERS ADMINISTRATION BUILDING BACHELOR OFFICERS' QUARTERS AND BARRACKS BUILDING	
DATE	BY
	<i>Channing</i>

Figure 20. Typical Landscape Planting Plans for Headquarters Administration Building, Bachelor Officers' Quarters and Barracks Buildings. Source: Office of History, Headquarters, U.S. Army Corps of Engineers, Alexandria, VA.

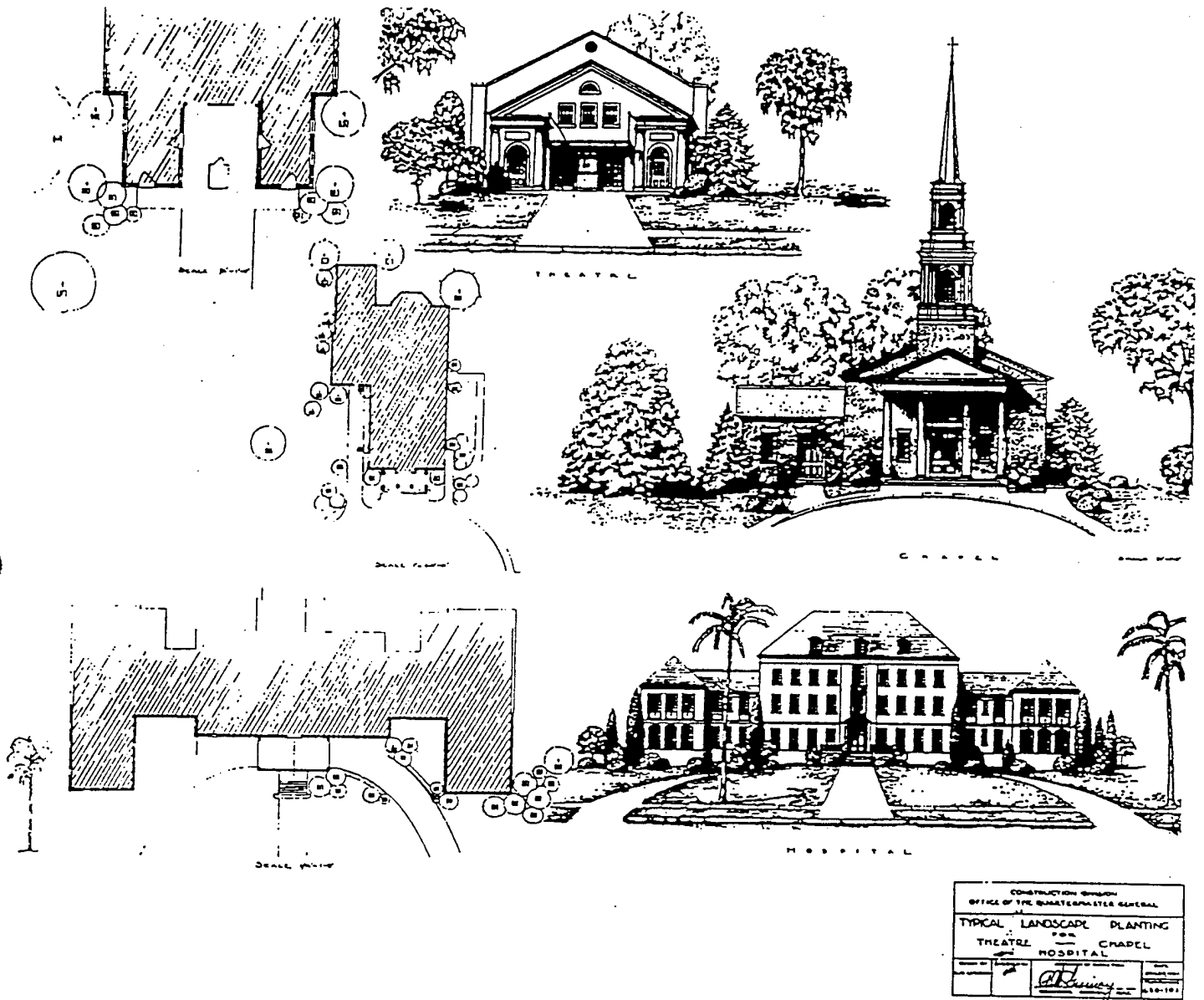

CONSTRUCTION DIVISION	
OFFICE OF THE QUARTERMASTER GENERAL	
TYPICAL LANDSCAPE PLANTING	
THEATRE	CHAPEL
HOSPITAL	
<i>A. Quincy</i>	
NOV-1917	

Figure 21. Typical Landscape Planting Plans for Theater, Chapel and Hospital Area. Source: Office of History, Headquarters, U.S. Army Corps of Engineers, Alexandria, VA.

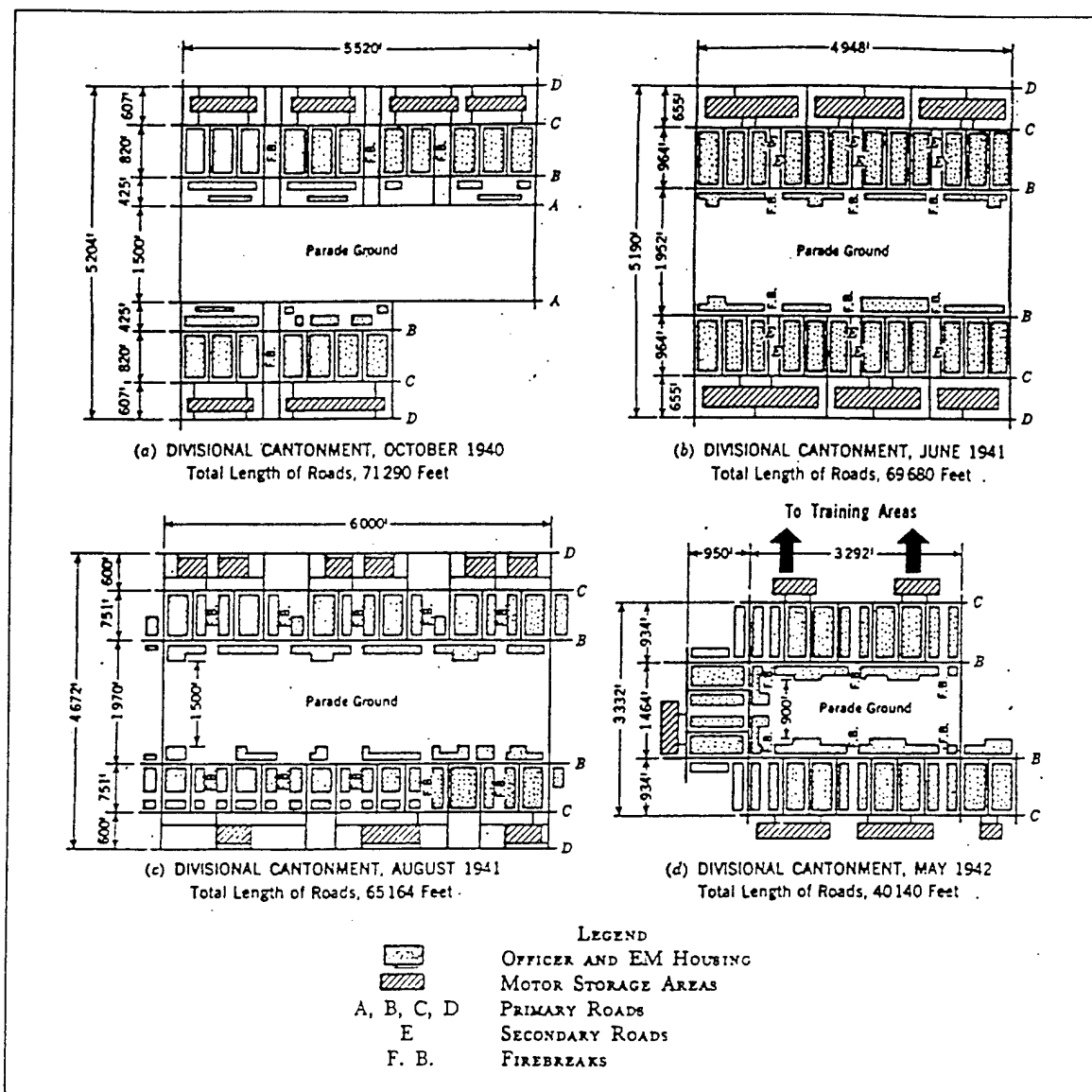

Figure 22--Evolution of site planning showing four increasingly efficient layouts for a divisional cantonment between October 1940 and May 1942. Source: Leon Zach, "Site Planning of Cantonment and Community Housing," *Civil Engineering*, August 1945, 364-65.

h) The Transition

1941, the last year that the Quartermaster Corps would include construction among its varied duties, was marked both by competition and cooperation with the Corps of Engineers. Both groups shared responsibility for the Army's construction and both were aware that the country would soon be at war. The transfer of responsibility for the Air Corps construction program to the Army Engineers in November of 1940 carried a critical "cutoff" date of July 1, 1942, when Air Corps construction would revert to the Quartermaster Corps. Within the year this program would be viewed by Congress as a practical test of the Engineer Department. In the meantime, building new bases for the Air Corps offered a considerable challenge.

The Construction Division continued to carry the burden of designing Air Corps structures from January to April of 1941, when the Engineers took up the task. In the early part of the year, the Engineer's inherited working arrangement with the Air Corps was termed "chaos". The exact number of projects and how much they cost was unclear and site selection was hampered by an Air Corps policy to accept all donated land. Moreover, the Air Corps was permitted by regulations to establish functional requirements, estimate costs, and recommend post layouts. In practice, the Air Corps often gave the Quartermaster Corps completed designs. Technically difficult because of their specialized nature,⁹⁵ the Air Corps needed structures "for testing and repairing engines, radios, armament, and equipment for storing bombsights, chemicals and explosives."⁹⁶ Buildings of these types were built at the four original Air Corps posts: San Antonio, Texas; Middletown, Pennsylvania; Patterson Field, Ohio; and Sacramento, California.

The plans received from the Air Corps were often flawed and included low safety factors. On occasion, the materials specified for temporary buildings were suited to permanent structures. Some estimates were based on how much had been appropriated rather than how much was actually needed for construction. By May 1941, the Engineers had evaluated the 700 series Quartermaster Corps plans and made several hundred changes to strengthen sagging floors, leaking roofs and fix other problems. The Engineer's ability to run a large, efficient field organization were paying off. By the end of the year congressional support of the Engineers increased as committees revealed Quartermaster shortcomings in the construction arena but no criticism of the Engineers.

Meanwhile, the War Department was trying to decide whether the Corps of Engineers or the Quartermaster Corps would be responsible for the Army's construction. Contractors stepped up the pressure with complaints to the War Department about having to deal with "two Army construction agencies, two sets of regulations, and two systems of bookkeeping."⁹⁷ Several organizational plans were considered, including establishing a separate corps headed by a major general and staffed with civilians. The debate over who was to be the Army's builder included discussion over whether maintenance and repair tasks were to be classed as a "house-keeping" (a Quartermaster Corps activity) or associated with civil engineering. Deliberations over the qualifications of the Corps of Engineers included a concern that the Engineers had wide experience with civil projects rather than day-to-day Army jobs.⁹⁸ The debate even drew in engineering societies who favored the Quartermaster Corps tradition of contracting for professional services and feared that the Engineer's policy of in-house design would result in less work for their members.

⁹⁵ The Engineers found that design standards for runway and taxiway pavements were based on methods of calculating loads for highways. This was acceptable when prewar commercial aircraft had loads of 12,500 pounds per wheel. However, bombers with 37,000-pound wheel loads were already in use and heavier aircraft were coming. Eventually the Engineers and the Air Corps agreed that runways would be built capable of withstanding wheel loads up to 60,000 pounds until 1944 when newer, heavier bombers were expected.

⁹⁶ Fine and Remington, 452.

⁹⁷ Ibid., 462.

⁹⁸ The issue of maintenance and repair was resolved in November 1941, when the chiefs of each division agreed that the Engineers would assume all duties that, in a city, would be done by a city manager. The Quartermaster General elected to be in charge of "branch depots and to run bakeries, laundries, shoe repair shops, and the like."

Lt. General Edmund B. Gregory, Quartermaster General, testifying at the House committee hearings in September and October of 1941, refused to be drawn over which branch should be responsible for construction. Only one branch, he said, should be responsible for construction but it was up to Congress to decide which. On October 16, at the conclusion of the hearings, the Senate voted to move construction to the Corps of Engineers. The House voted for the transfer bill on November 21, and President Roosevelt signed the measure into law on December 1, 1941.⁹⁹

There were several plans for consolidation of the two agencies before the transition passed into law. The proposed Construction Division office of the Corps of Engineers in Washington was reminiscent of the Quartermaster's Construction Division, with five branches: Engineering, Operations, Contracts and Claims, Real Estate, and Repairs and Utilities. In the field, because the Engineer divisions did not match the Army's main corps areas, several proposals were offered including an unpopular centralized organizational scheme that allowed District Engineers a direct line of authority from the Chief Engineer. This proposal brought unanimous criticism from the division engineers who justified it with concerns over duplicating the Quartermaster's centralized organization and the problems associated with it.

The matter was resolved when the Chief Engineer decided district engineers were to report to division engineers on everything but repairs and utilities. The Construction Division transferred accounts, real property and files, "and prepared implementing orders." Regular Quartermaster officers with construction experience were offered the choice of transferring to the Corps of Engineers or staying with the Quartermaster Corps and being assigned to other duties. The transfer of responsibilities to the Corps of Engineers became effective on December 16, 1941.

D. CONCLUSION

From the early days, the Quartermaster Corps was charged with broad, primary responsibilities in fields of Army supply. The history of the Quartermaster Corps follows a recurrent pattern of wartime expansion followed by peacetime cutbacks. Unable to prepare for wartime emergencies in years of financial constriction, the Quartermaster Corps was hard-pressed to respond during war. During the nineteenth century the nation was at war for a mere 9 out of 100 years. It is no surprise that Quartermaster officers, like their civilian brothers, looked upon military preparedness with a skeptical attitude.

Protected by a broad expanse of water and sheltered by the British navy that patrolled it, they felt no menace to their way of life. ...they enjoyed the advantages of low defense costs and could afford the luxury of a small Army, only large enough to provide police action against the Indians who obstructed the westward movement.¹⁰⁰

Things improved in the early twentieth century but the Quartermaster Corps still operated with

⁹⁹ 55 Stat. 787 and 87th Congressional Record, 9005, 9400.

¹⁰⁰ Risch, 739.

barely enough funding to get by in peacetime and a pervasive public indifference to the Army after World War I. The Quartermaster Corps was, however, among the first called upon to prepare for war and was required "to transport, shelter, clothe, equip and subsist immediately a rapidly mushrooming force."¹⁰¹ Congress always made funds available, eventually, to pursue the war effort but industry needed time to retool and begin production of war materials. Shortages of raw materials had to be overcome and plans had to be developed to redirect the products of the nation's labor force. At the end of a war, the Army always demobilized and the size of the Regular Army was reduced. Constriction became the order of the day, leaving the Quartermaster Corps unprepared when the next war broke out.

The Quartermaster Corps was plagued by problems of under-funding, over-centralization and the lack of adequate numbers of architects and engineers. When Major General Nathaniel Green, serving in the Revolutionary War, became Quartermaster General he was heard to complain, "no one ever heard of a quartermaster."¹⁰² This combat soldier's observation applied equally well to conditions surrounding the Quartermaster Corps before World War I. In spite of these problems, the Quartermaster Corps consistently rose to the challenge and, in World War II, undertook a vast construction effort that, when it was taken over by the Corps of Engineers, was well started. This construction program included "camps and cantonments to house 5.3 million troops; plants to mass-produce explosives, ammunition, tanks, and planes; hospitals providing nearly half a million beds; a huge network of ports and depots; and bomber bases which entailed a whole new technology..."¹⁰³ The information in **Table 19** indicates that in December 1941, the Quartermaster Corps was working on 220 projects and had completed 375 projects. This, however, does not indicate the pace at which the Corps had been working. Five months earlier, the Quartermaster Corps had completed only 100 projects and had 324 in progress. One of these projects, designed between July and October, was being built in December by 4,000 men working three shifts a day and would take eight years to complete. This project was the Pentagon.

TABLE 19--SUMMARY OF QUARMASTER PROJECTS
COMPLETED AND UNDER WAY ON DECEMBER 5, 1941¹⁰⁴

Projects	Completed	Under Way	Value of Work in Place
Camps and Cantonments.....	61	10	\$623,532,764
Reception Centers.....	47	---	8,640,794
Replacement Training Centers.....	25	4	110,665,861
Harbor Defenses.....	37	8	26,549,331
Miscellaneous Troop Facilities.....	113	87	148,009,863
General Hospitals.....	19	6	24,716,258
Ordnance Plants.....	20	40	663,865,631
Ordnance Ammo Storage Depots.....	2	7	72,859,862
Misc. Ordnance Facilities.....	6	20	38,327,548,
Chemical Warfare Service Plants.....	7	4	26,815,370
Storage Depots (excluding Ammo).....	9	23	76,512,266
Miscellaneous Projects	29	11	7,772,505

¹⁰¹ Ibid., 739.

¹⁰² Risch, 740.

¹⁰³ Fine & Remington, Preface ix.

¹⁰⁴ Ibid., 417. Those projects that were more than 95% complete were included.

Projects	Completed	Under Way	Value of Work in Place
TOTAL COMPLETED	375	220	\$ 1,828,268,053

The wisdom of the Quartermaster Corps decision to develop and use standardized plans was eloquently confirmed in General Eugene Reybold's musings on the Allied victory in World War II. "Construction power had been a decisive factor in victory. ...camps and cantonments had been key to mobilization; munitions plants to rearmament; and airfields, to air superiority."¹⁰⁵ Little of this nation-wide accomplishment could have been attained without the Quartermaster Corps or standardized plans.

The achievements of the Quartermaster Corps are still seen and felt at Army installations. The Quartermaster Corps designs are easily recognized in the large, permanent barracks and single family houses associated with the housing program of 1926. Less easily recognized but equally strong contributors to the nation's architectural history are support buildings like World War II warehouses, hospitals, garages and work shops--all built from standardized plans. Less obvious design features that form an integral part of our legacy from the Quartermaster Corps include: circulation patterns, street profiles, designed land use areas and carefully conceived plans for landscape planting. All of these exploits are visible at large installations where all of these designs can be found, or at small posts where only a few buildings and structures were built from standardized plans. The effect is intensified when an understanding of the architectural heritage of several bases is achieved: the same buildings with intentional regional differences are observed, patterns of base layouts emerge and the magnitude of the work undertaken by the Quartermaster Corps unfolds.

¹⁰⁵ Ibid., 701.

E. BUILDING TYPES

Context Statements for Individual Building Types

Introduction

This part of the study contains selected context statements for individual building types, and drawings and photographs from various sources which demonstrate examples of the Quartermaster General Standard Plans.

Each section is prefaced by a written introduction that describes the building type, its historical evolution, and discusses the issues of association and integrity as they relate to that specific building type.

The division of building types and the introductions to each section were taken directly from *National Historic Context for Department of Defense Installations, 1790-1940* by R. Christopher Goodwin & Associates, Inc., 1995, which was developed for the U.S. Army Corps of Engineers, Baltimore District. The original text has been edited to conform to the requirements of this study, with references which do not apply to Army buildings and footnotes having been removed.

The drawings in this part of the study were obtained from three main sources. The database (**Part F**) identifies the specific source of each document. Some drawings are copies of drawings found in the files of individual installations; some came from the National Archives in Washington, DC; and others were found in two early editions of the Quartermaster Corps Manuals: the *Manual of the Construction Division of the Army, Section C, Engineering Division, 1918* and the *Manual for the Quartermasters Corps, U.S. Army, 1916-17*.

The photographic figures in this part were provided by the Technical Center of Expertise for Preservation of Structures and Buildings, Seattle District, U.S Army Corps of Engineers.

Installation personnel can use the drawings and photographs in this part of the study in conjunction with the database listing in Part F to locate, identify, and compare buildings on their installation and determine whether they may be part of the Quartermaster Standard Plans system.

The drawings and photographs included in this report represent a random sampling of the individual building types and are not meant to be comprehensive. They provide a guide to installation personnel for identifying the characteristics of the different types of historic structures on their installations. Individual buildings on specific installations may vary substantially from those types shown here, and each structure will need to be evaluated on its own individual merit.

JOB 620 TYPICAL BUILDINGS FOR CAMPS & CANTONMENTS DESCRIPTION & REFERENCE DRAWINGS												
SHEET	NAME OF BUILDING	SIZE IN FEET	DEND	HEIGHT	NOTES UNLESS OTHERWISE NOTED ALL DLGS ARE OF WOOD CONST.	CONSTR DETAILS	ELECT	PLUMB	MACH	HEAT	WATER	VERED
332	SHED - WAGON OR GUN	29x44	9'-0"	1-STORY	OPEN TWO SIDES.							
372	SHOP	20x36	6'-0"	1 -		317	367				329 330	325
381	CLOTHING SHOE REPAIR - PRINTING	30x102		1 -	STORE ROOMS & TOILETS.	314	367				329 330	325
437	CLOTHING SHOE & HAT REPAIR	60x100	10'-0"	2-STORY	" " " "	386	334	367		438	329 330	325
467	CLOTHING REPAIR CLOTHING AND HAT REPAIR	28x132 28x132	10'-0" 10'-0"	1-STORY 1 -	STORE ROOMS. "	334	367			468	329 330	325
436	COT REPAIR	40x36	10'-0"	1 -	WORK AND SUPPLY ROOMS.	334	367				315 330	325
478-479	MOTOR REPAIR	75x96	24'-0"	1 -	SHOP ROOMS INCLUDED.	464	367	352	351	465		325
387-388	" " "	60x130	27'-4"	1 -	SHOP ROOMS INCLUDED	389	334	367		498		325
390	QUARTERMASTER & BUILDINGS EACH	36x106	11'-9"	1 -	YARD BETWEEN DLGS 40'x106'	324	367				329 330	325
439	TEMP TREATING	36x48	10'-0"	1 -	WORK AND SUPPLY ROOMS.	334	367				329 330	325
440	" REPAIR	40x60	10'-0"	1 -	" " " "	334	367				329 330	325
395	SHOP	20xVAR	7'-0"	1 -		317	367				329 330	325
451	SHOWER SHELTER & WASH HOUSE - (BATTALION)	20x80	8'-0"	1 -	MEN'S WASH, SHOWER & DRESSING ROOMS. OFFICERS SHOWERS.	350	367			351	329 330	325
NORTHERN AND SOUTHERN CONSTRUCTION ... 320-2-162						ZONES MAP						
395	STABLE GUARD	20x21	7'-0"	1-STORY		317	367				329 330	325
376	STABLE - OPEN	24xVAR	10'-0"	1 -	4 ANIMALS TO EACH BENT.							
421	" CLOSED	29xVAR	10'-0"	1 -	FORAGE AND SADDLE ROOMS.		367					325
412-413	STORE HOUSE - SALVAGE	60x60	12'-0"	1 -	PLATFORM ONE SIDE.	413	334	367				325
319	" DIVISIONAL	60x160 UNITS	9'-9"	1 -	UNITS DIVIDED BY BRICK FIRE WALLS. 10' PLATFORM EACH SIDE		367					
467-468	" " "	60x160	9'-9"	1 -	ONION & POTATO STORAGE - INSULATED. 10' PLATFORM EACH SIDE		367				329 330	325
318	" REGIMENTAL	20xVAR	7'-0"	1 -			367				329 330	325
418	TEL. OFFICE & QUARTERS	20x110	10'-0"	1 -	TELEGRAPH OFFICE - 10 DED RM - DETACHED LAV. 14'x34'	317	334	367	350	351	417	325
328	TELEPHONE TELEGRAPH BLDG	20x70	7'-0"	1 -	1 - ROOM EACH FOR OPERATOR - OPER- ATING TERMINAL & TELEG. OFFICE	334	367			464	329 330	325 325
499-500	LIBERTY THEATRE	60x120	8'-0"	1 -	AUDITORIUM SEATING 1250. STAGE 50x60 ADDED. 10' PLATFORM	400					503	329 330
385-386	WAREHOUSE FOR CLOTHING	60x100	10'-0"	2-STORY	2 OFFICES - TOILETS & ELEVATOR	334	367					325
432	WASTE & TRANSFER STA.	20x130	10'-0"	1-STORY	WASHING FROM 20x30 OPEN PLATFORM 20'x100'		367	352	351			
473	WATER COOLING & CONDENSER	8x25	10' HIGH		ALSO TO BE BUILT IN CONNECTION WITH REFRIGERATOR PLAN.	(SEE 471)						
325	VENTILATORS GALVANIZED STEEL.	(FOR CAPACITIES, SCHEDULES & DETAILS)										325

SCHEDULE FOR REMOUNT STATIONS.

DESCRIPTION	JOB 404	DESCRIPTION	JOB 404
PLAN FOR RIGGING AND CARGO CORRAL. CARGADOR'S SHOP AND PACK HOUSE.	23	TYPICAL RECEIVING CORRAL.	36
CARGADOR'S SHOP	24	TYPICAL BLACKSMITH SCHOOL SHOP.	37
RIGGING AND CARGO CORRAL.	25	HAY RACK AND FEED TROUGH COMBINED	39
PACK HORSE FOR INSTRUCTION IN PACKING.	26	ANIMAL SHELTER.	42
HAY RACK AND FEED TROUGH.	27	OPERATION ROOM OR FORAGE ROOM.	43
TYPICAL FENCE AND GATE.	28	SHED FOR HAY CHOPPING AND OAT CRUSHING.	44
COVERED CHUTE AND PEN.	29	TYPICAL OUTSIDE ELECTRIC WIRING PLMS	45
TYPICAL UNLOADING PLATFORM. PENS, GATES, CHUTES & RAMP.	30 & 31	SHELTER SHED WITH HAY RACK & FEED TROUGH.	46
MANURE LOADING PLATFORM.	32	PLAN CHANGING LARGE CORRAL INTO (4) FOUR SMALLER CORRALS	47
DIPPING TANK.	33	STATION FOR TSCO ANIMALS.	48
BLACKSMITH AND WHEELWRIGHT SHOP	34		
SHED FOR ISOLATION CORRAL.	35		

Source: Manual of the Construction Division of the Army, Section C, Engineer Division, Washington, DC, 1919. Plate 44.

MISCELLANEOUS-BUILDINGS-DESCRIPTION & REFERENCE-DRWGS

NOTE: REFERENCE DRAWINGS HAVE SAME JOB NUMBER UNLESS OTHERWISE NOTED.

JOB	DRWG	NAME OF BUILDING	SIZE	BENTS	HEIGHT	NOTES	UNLESS OTHERWISE NOTED ALL BLDGS ARE OF WOOD CONST.		ELEC.	PLUMB.	HOT WATER	STEAM HEAT.	VENTS.
							CONSTR. DETAILS	CONSTR. DETAILS					
606	19-20 21-22	AUDITORIUM.	200-300	23'-0"		FRAME & STUCCO. PLASTERED INSIDE. STEEL TRUSSES AND WOOD ROOF.	20	22	29		41	620-325	
6339	131	CAFETERIA.	54-189	14'-6"	1STORY	TWO DINING ROOMS 54-50', KITCHEN AND STORE ROOMS.	133	134	131	131			
6370	106	"	132-173	12'-0"	2 STRS	CAP. OFFICERS 118, MEN 477, WOMEN 712, KITCHEN AND BED ROOMS FOR 20 BEDS.	106	108	106	105	109	620-325	
6209	113	"	105-192	16'-0"	1STORY	4 DINING RMS. SEATS 244 EACH. KITCHEN & STORE RMS, CAP. 2000	112	113	112	112	112	620-325	
6383	110	"	110-171	"	"	2 DINING RMS SEATS 194 EACH. KITCHEN 7' x 10' - 1/2' & ETC.	111	112	112	110	112	620-325	
6403	111	"	156-200	"	2 STRS	MENS DINING RM. SEATS 1000 KITCHEN 580' & ETC.	111	113	101	101	114	620-325	
632	551	DELOUSING PLANT.	48-84	12'-0"	1STORY	24 MEN PER 1/2 HOUR.	551		551	591	591	620-325	
"	550	"	54-120	"	"	48 MEN PER 1/2 HOUR.	550		550	590	590	620-325	
"	552	"	60-204	"	"	130 MEN PER 1/2 HOUR.	552		552	589	589	620-325	
6307	110	DORMITORY FOR MEN	28-113	15'-0"	2 STRS	40 SINGLE BED ROOMS, SOCIAL HALL, 14'x27' & ETC.	6316 101		110	110		6316 101	
"	121	DORMITORY & DINING ROOM	29-136	"	"	30 SINGLE BED ROOMS, KITCHEN DINING ROOM 28-29' & ETC.	6316 101		121	121	121	6316 101	
6339	111	"	29-136	"	"	60 SINGLE BED ROOMS, SERVING RM DINING ROOM 29-30' & ETC.	6316 101		111	111	111	6316 101	
6242	5	GARAGE	140-44	16'-0"	1STORY	MECHANICAL REPAIR UNIT NO 305.	5		5	5		620-325	
6311	105	"	61-164	18'-0"	"	SCULPTURE PROVING GROUNDS, MASS.	106		158	105		620-325	
652	17	ORDNANCE	15-10-17	20'-0"	"	TILE WALLS, WOOD TRUSSES. HEATER ROOM.	17		17	17		620-325	
"	214	GUARD HOUSE, TYPE N1	12-5-6	7'-0"	"		214		214	214		620-325	
6143	2	GAS INSTRUCTION.	16-30	"	"		2						
6309	121	HOUSING, 4 FAMILY HOUSE	28-58	"	2 STRS	KITCHEN, LIVING ROOM & TWO BED ROOMS. EACH	102 103	104	105	105		6316 101	
"	180	"	24-26	"	"	KITCHEN, DINING RM, LIVING RM. AND THREE BED ROOMS.	102 103	104	105	105		6316 101	
"	160	BOARDING	27-38	"	"	KITCHEN, LIVING ROOM AND EIGHT BED ROOMS.	102 103	104	105	105		6316 101	
"	150	FAMILY.	24-30	"	1STORY	KITCHEN, LIVING RM & TWO BED RMS.	102 103	104	105	105		6316 101	
"	190	"	24-32	"	"	KITCHEN, LIVING ROOM AND TWO BED ROOMS.	102 103	104	105	105		6316 101	
"	200	"	25-36	"	2 STRS	KITCHEN, DINING, LIVING AND THREE BED ROOMS. EACH.	102 103	104	105	105		6316 101	
633	140	LAUNDRY.	36-108	18'-0"	1STORY	1000 TO 2000 MEN	101	102	140	142	141	141	
"	130	"	72-216	"	"	5000 TO 10000 MEN.	101	102	130	132	131	131	
"	110	"	144-252	"	"	10000 TO 20000 MEN.	101	102	110	112	111	111	
"	120	"	210-170	"	"	40000 MEN.	101	102	120	122	121	121	
608	104	LECTURE HALL.	51-77	15'-0"	"	SEATING CAP. 500.	104		610 347			620-325 620-325	
652	7	MAGAZINE-TYPE N1	51-219	20'-0"	1STORY	TILE WALLS & WOOD TRUSSES.	7					620-325	
"	9	"	51-219	"	"	"	9					620-325	
"	179	"	49-208	16'-0"	"	TILE OR BRICK WALLS.	179					620-325	
"	180	FOR HIGH EXPLOSIVES	26-42	"	"	TILE WALLS, CEILING INSIDE. PLATFORM AT ONE END.	180						
"	31	FOR HIGH EXPLOSIVES	26-42	"	"	CORR. ASBESTOS SIDING. CEILING INSIDE. PLATFORM AT ONE END.	31						
"	169	FOR HIGH EXPLOSIVES	26-42	"	"	TILE WALLS, CEILING INSIDE. PLATFORM AT ONE END.	169						
6196	104	BLACK POWDER	16-22	"	"	CORR. ASBESTOS SIDING. CEILING INSIDE.	104		104				
652	146	SPOORLESS POWDER	32-96	16'-0"	"	CORR. ASBESTOS SIDING. CEILING INSIDE. PLATFORM AT ONE SIDE.	146						
"	173	PRIMER & USE HOUSE, TYPE N1	32-96	"	"	TILE WALLS, CEILING INSIDE. PLATFORM AT ONE SIDE.	173						
"	174	"	32-96	"	"	TILE WALLS, CEILING INSIDE. PLATFORM AT ONE END.	174						
"	152	PYROTECHNIC PLANT, TYPE N1	20-35	"	"	SALT PETER STORAGE. PLATFORM AT ONE END.	152					620-325	
"	157	"	30-161	13'-0"	"	BRICK END WALLS, RECEIVING AND DISCHARGING ROOMS & BENCH WORK.	157					620-325	
"	158	"	30-104	"	"	BRICK END WALLS, RECEIVING AND DISCHARGING ROOMS & BENCH WORK.	158					620-325	
"	165	SHED, DOCK TYPE N2	60-221	20'-0"	"	TILE WALLS, STEEL TRUSSES. PLATFORMS AT END AND SIDE.	165		165			620-325	
"	19	SHOP, ORDNANCE REPAIR.	30-80	"	"	OPTICAL, VEHICLE REPAIR, SADDLER CARPENTER, ARMORER & BENCH WORK.	19		19			620-325	
"	158	STORAGE BATTERY STATION	39-156	20'-0"	"	TILE WALLS, WOOD TRUSSES. METAL WINDOWS. PLATFORMS.	158		158			620-325	
"	43	STORAGE BUILDING VEHICLES.	113-513	16'-0"	"	TILE WALLS, BRICK FIRE WALLS, METAL WINDOWS. PLATFORM.	43					620-325	
"	188	STORAGE BUILDING VEHICLES.	161-VAR	"	"	TILE WALLS, BRICK FIRE WALLS, METAL WINDOWS. PLATFORMS.	188		188			620-325	
"	41	STOREHOUSE GENERAL.	161-501	20'-0"	"	TILE WALLS, BRICK FIRE WALLS, METAL WINDOWS. PLAT. BOTH SIDES.	41					620-325	
"	74	"	161-VAR	20'-0"	"	TILE WALLS, BRICK FIRE WALLS, METAL WINDOWS. PLAT. BOTH SIDES.	71		71			620-325	
6271	7	STORAGE DEPOT, ADM. BLDG.	140-160	"	2 STRS	BRICK WALLS, SHED ATTACHED. PLATFORMS. SEE PLAT PLAN 6271-S	7	5	10				
"	12	"	153-126	"	1STORY	CINDER PLATFORM.	12	5	12				
"	17	"	161-VAR	"	"	BRICK WALLS, CHARGING STATION, PLATFORM, TOILETS & ETC.	17	5	12				
608	24	THEATRE, CLASS-A.	120-187	"	"	SEATING CAP. OVER 3000.	23 23	24 27	30			6316 101	
"	34-33 34-210	"	75-167	15'-6"	"	SEATING CAP. 2100 WITH BALCONY.	31 32	33 106	31	31		31	
652	81	TRANSFORMER STA. TYPE N1	20-36	"	1STORY	BRICK WALLS, CONCRETE ROOF AND METAL WINDOWS.	81		81			620-325	
6399	120	WELFARE BLDG.	84-96	10'-0"	"	ADDITONAL SEATING CAP. 200. BILLIARD & READING ROOMS.	120		103	103		6316 101	

Source: Manual of the Construction Division of the Army, Section C, Engineer Division, Washington, DC, 1919. Plate 67.

TYPICAL HOSPITAL BUILDINGS DESCRIPTION AND REFERENCE DRAWINGS

PAVILION TYPE

NOTE - BUILDINGS OF THIS TYPE ARE OF WOOD

S.G.O. SYMBOL	BUILDING	SIZE	STORY	DESCRIPTION	CONST. DETAILS	ELECTRICAL 632	PLUMBING 632	MECHANICAL 632	STEAM	VACUUM & QUANTITY
B	ADMINISTRATION	33'-6" x 116'	1	OFFICES, ETC.	Z-1	254	254			V 254 G
C	OFFICERS WARD	8'-6" x 150'-6"	1	ROOMS, TOILET, MESS & KITCHEN	"	227	227	537		226 "
D-D ⁺	" QUARTERS	24' x 150' 24' x 35'-6"	2	CAP. 22 ROOMS & 2 TOILETS	"	157	157	537	257 "	
E	NURSES QUARTERS	8'-6" x 157'	1	CAP. 24 ROOMS, 2 TOILETS, MESS AND KITCHEN	"	282	282	537		281 "
F	LABORATORY	24' x 104'-6"	1	EYE, EAR, THROAT, DENTAL & X-RAY	"	266	266			265 "
C	OPERATING PAVILION	24' x 93'	1	PUS. DRESSING ROOM AND CLEAN OPERATING ROOM, ETC.	"	291	291			290 "
H	POST EXCHANGE	24' x 84'	1	STORE ROOM, BARBER SHOP, BILLIARDS & LAVATORY	"	203	203			203 "
H	GARAGE & SHOP	24' x 36' 24' x 150'	1	6 AMBULANCES, CARPENTER, ETC.	"				214 "	
I	MESS & KITCHEN	24' x 150'	1	CAP. 280 MEN OR 10 PER SEATING	"		272		271 "	
I ²⁸	GENERAL MESS & KITN	108' x 120'	1	CAPACITY 300 SEATINGS	"	1-28	663			714 "
J	RECEIVING WARD	8'-6" x 150'-6"	1	RECEIVING/DISCHARGING, DRESSING ROOM, OBSERVATION, STORAGE, ETC.	"	221	221	584	220 "	
K	SINGLE WARDS	24' x 150'-6"	1	CAP. 32 BEDS, TOILETS, OFFICE, DIET KITCHEN	"	190	190			189 "
L	WARD & LABORATORY	24' x 157'	1	CAP. 36 BEDS, TOILET, OFFICE, ETC.	"	298	298		297 "	
M	ISOLATION WARDS	24' x 150'-6"	1	CAPACITY 32 BEDS, OFFICE, ETC.	"		192	584		450 "
N&N ²	HOSPITAL CORPS BARRACKS & LAVATORY	24' x 156' 24' x 30'	2	CAPACITY 42 BEDS, 4 ROOMS, ETC.	"	225	151	537		224 "
O	STORE HOUSE	24' x 150'	1	2 OFFICES, SHELVING, ETC.	"	211			210 436 "	
P	CHAPEL	24' x 58'-6"	1	CAPACITY 200 SEATINGS	"		201		310 "	
P	GUARD HOUSE	24' x 36'	1	OFFICE, GUARD RM, PRISONERS RM.	"	322	322		322 "	
P	MORTUARY	24' x 35'-6"	1	VIEWING RM., MORTUARY & POST MORTEM	"		218		381 "	
Q	LAUNDRY	24' x 150'-6"	1	FOR EQUIPMENT SEE DRWG. Q ⁵	"		310			
R	PSYCHIATRIC WARD	24' x 162'	1	CAP. 10 BEDS, TOILET, EXAM. ROOMS, - ROOMS, ETC.	"	194	194			193 "
	FIRE STATION	31' x 87'-10"	1	APPARATUS	620-365 SERIES					
	BOILER HOUSE	43' x 45'-6"	1	BOILER RM., PUMPS, FUEL	412-2					
	RED CROSS	100' x 100'	1	OFFICES, ASSEMBLY RM., SOLARIUM, ETC.						

HEADHOUSE TYPE
NOTE - BUILDINGS OF THIS TYPE ARE WOOD FRAME & STUCCO. FOR TILE BUILDINGS, SEE DENVER 62T2-41.

B-9	2 STORY ADMINISTRATION	96' x 156'	2	OFFICES	Z13-108	B-9	654			701 G
C-10	" OFFICERS WARD	48' x 222'	2	CAPACITY 69 BEDS, H-HOUSE AND QUIET ROOMS	"	C-10	653			702 "
D-10	" " QUARTERS	50' x 56'	2	CAPACITY 49 OFFICERS, 2 STAFF OFFICERS WITH LIVING RM., LAV, ETC.	"	D-10	662			703 "
D-11	" " QTS, MESS & KITN	30' x 156'	2	CAPACITY 100.	"	D-11	661			704 "
E-10	" NURSES QUARTERS	30' x 156'	2	CAPACITY 51 BEDS	"	E-20	660	582		705 "
E-21	" " QTRS & INFIR, 2 nd FL.	30' x 156'	2	CAPACITY 40 BEDS	"	E-21	656	582		706 "
E-22	" " MESS & KITN	30' x 156'	2	CAPACITY 250	"	E-22	659			707 "
F-21	" LAB & MORTUARY	32' x 108'	2	FOR EQUIPMENT, SEE DRAWINGS.	"	F-21	658			708 "
G-7	" SURGICAL WING (2 PLS)	48' x 222'	2	1 st FL. PUS. DRESSING, RECLEAN OPRTG. RM. 2 nd FL. EYE, EAR, NOSE, X RAY & DENTAL DEPT.	"	G-7	655			709-710 "
H-12	1 STORY GARAGE	48' x 48'	1	CAP. 8 MACHINES, WASHING ROOM.	"	H-12				711 "
H-13	" SHOP BUILDING	32' x 108'	1	SHOP TAILOR, COBBLER, CARPENTER, BLACKSMITH, MATTRESS REPAIR, ETC.	"	H-13				712 "
H-14	2 " HOSPITAL EXCHANGE	24' x 84'	2	STORE, BARBER, SHOP, ETC.	"	H-14				713 "
I-28	1 " GENERAL MESS & KITN	60' x 108' 36' x 180'	1	CAP., CAFE 530 MEN, GENL. MESS 530 MEN	"	I-28	663			714 "
K-34	2 " WARDS (2 PLS)	48' x 222'	2	CAP. WARD 100 BEDS, H-HOUSE 100 BEDS, LABORATORY & NURSES RESTING RM.	"	K-34	664	584		715-716 "
M-3	" ISOLATION WARD (2 PL)	48' x 222'	2	CAP. 52 BEDS, H-HOUSE 10 BEDS, LAVATORY & NURSES ROOM	"	M-3	666			717-718 "
M-4	" " " "	48' x 222'	2	CAP. WING 52 BEDS, H-HOUSE 7 BEDS	"	M-4	665			719-720 "
N-9	" HOS. CORPS BARRACKS	36' x 168'	2	CAPACITY 100 BEDS	"	N-9	667	584		721 "
N-10	HOS. CORPS DETACHMENT BARRACKS, MESS & KITCHEN	36' x 168'	2	CAP. 100 BEDS, CAFETERIA 625 SEATS	"	N-10				723 "
O-10	1 STORY STORE HOUSE	32' x 120'	1	OFFICE, STORE RM., SHELVING	"	O-10				724 "
P-6	" CHAPEL	34' x 54'	1	CAPACITY 350	"	P-6				725 "
P-7	" GUARD HOUSE	24' x 60'	1	OFFICE, GUARD RM., PRISONERS RM.	"	P-7				726 "
Q	" LAUNDRY	24' x 150'-6"	1	FOR EQUIPMENT SEE DRWG. Q ⁵	Z13-108	Q	310			
R-4	2 " PSYCHIATRIC WARD	48' x 222'	2	CAP. WARD 36 BEDS, H-HOUSE 20 BEDS, LABORATORY & NURSES ROOM	"	R-4	657			727-728 "
	" POWER HOUSE	43' x 45'-6"	1	BOILER RM., PUMPS, FUEL	412-2					
	" FIRE STATION	31' x 87'-10"	1	APPARATUS	620-341 SERIES					
	RED CROSS	100' x 100'	1	OFFICES, ASSEMBLY RM. & SOLARIUM						

Source: Manual of the Construction Division of the Army, Section C, Engineer Division, Washington, DC, 1919. 85.

DESCRIPTION OF REFRIGERATING AND ICE MAKING PLANTS
REFRIGERATION SECTION ... CONSTRUCTION DIVISION ... WAR. DEPT.

TYPE PLANT	BUILDING OVERALL AND CAPACITY	NO. OF CATTLE	BEEF D		PROVISIONS NO. 1 P		PROVISIONS NO. 2 P		ICE STORAGE				COMPRESSOR CONDENSERS				ICE MAKING				MOTOR		PLAN NO.				
			PL PIPE 2"	SIZ ROOM	CAL PERISHABLE	PL PIPE 2"	SIZ ROOM	CAL PERISHABLE	PL PIPE 2"	SIZ ROOM	CAL PERISHABLE	ICE STORAGE	ICE STORAGE	ICE STORAGE	ICE STORAGE	ICE STORAGE	ICE STORAGE	ICE STORAGE	ICE STORAGE	ICE STORAGE	ICE STORAGE	ICE STORAGE		ICE STORAGE	ICE STORAGE	ICE STORAGE	ICE STORAGE
A	30000	110	2000'	81'-0" x 107'-0"	1 1/2 - 2	775'	750'	625'	2500'	1830'	3080'	2 SECTIONS	2 SECTIONS	2 SECTIONS	2 SECTIONS	2 SECTIONS	2 SECTIONS	2 SECTIONS	2 SECTIONS	2 SECTIONS	2 SECTIONS	2 SECTIONS	2 SECTIONS	2 SECTIONS	2 SECTIONS	2 SECTIONS	2 SECTIONS
B	40000	160	2020'	81'-0" x 107'-0"	1 1/2 - 2	775'	750'	625'	2500'	1830'	3080'	2 SECTIONS	2 SECTIONS	2 SECTIONS	2 SECTIONS	2 SECTIONS	2 SECTIONS	2 SECTIONS	2 SECTIONS	2 SECTIONS	2 SECTIONS	2 SECTIONS	2 SECTIONS	2 SECTIONS	2 SECTIONS	2 SECTIONS	2 SECTIONS
C	40000	160	2020'	81'-0" x 107'-0"	1 1/2 - 2	775'	750'	625'	2500'	1830'	3080'	2 SECTIONS	2 SECTIONS	2 SECTIONS	2 SECTIONS	2 SECTIONS	2 SECTIONS	2 SECTIONS	2 SECTIONS	2 SECTIONS	2 SECTIONS	2 SECTIONS	2 SECTIONS	2 SECTIONS	2 SECTIONS	2 SECTIONS	2 SECTIONS
D	40000	160	2020'	81'-0" x 107'-0"	1 1/2 - 2	775'	750'	625'	2500'	1830'	3080'	2 SECTIONS	2 SECTIONS	2 SECTIONS	2 SECTIONS	2 SECTIONS	2 SECTIONS	2 SECTIONS	2 SECTIONS	2 SECTIONS	2 SECTIONS	2 SECTIONS	2 SECTIONS	2 SECTIONS	2 SECTIONS	2 SECTIONS	2 SECTIONS
E	40000	160	2020'	81'-0" x 107'-0"	1 1/2 - 2	775'	750'	625'	2500'	1830'	3080'	2 SECTIONS	2 SECTIONS	2 SECTIONS	2 SECTIONS	2 SECTIONS	2 SECTIONS	2 SECTIONS	2 SECTIONS	2 SECTIONS	2 SECTIONS	2 SECTIONS	2 SECTIONS	2 SECTIONS	2 SECTIONS	2 SECTIONS	2 SECTIONS
F	40000	160	2020'	81'-0" x 107'-0"	1 1/2 - 2	775'	750'	625'	2500'	1830'	3080'	2 SECTIONS	2 SECTIONS	2 SECTIONS	2 SECTIONS	2 SECTIONS	2 SECTIONS	2 SECTIONS	2 SECTIONS	2 SECTIONS	2 SECTIONS	2 SECTIONS	2 SECTIONS	2 SECTIONS	2 SECTIONS	2 SECTIONS	2 SECTIONS
G	40000	160	2020'	81'-0" x 107'-0"	1 1/2 - 2	775'	750'	625'	2500'	1830'	3080'	2 SECTIONS	2 SECTIONS	2 SECTIONS	2 SECTIONS	2 SECTIONS	2 SECTIONS	2 SECTIONS	2 SECTIONS	2 SECTIONS	2 SECTIONS	2 SECTIONS	2 SECTIONS	2 SECTIONS	2 SECTIONS	2 SECTIONS	2 SECTIONS
J	40000	160	2020'	81'-0" x 107'-0"	1 1/2 - 2	775'	750'	625'	2500'	1830'	3080'	2 SECTIONS	2 SECTIONS	2 SECTIONS	2 SECTIONS	2 SECTIONS	2 SECTIONS	2 SECTIONS	2 SECTIONS	2 SECTIONS	2 SECTIONS	2 SECTIONS	2 SECTIONS	2 SECTIONS	2 SECTIONS	2 SECTIONS	2 SECTIONS
K	40000	160	2020'	81'-0" x 107'-0"	1 1/2 - 2	775'	750'	625'	2500'	1830'	3080'	2 SECTIONS	2 SECTIONS	2 SECTIONS	2 SECTIONS	2 SECTIONS	2 SECTIONS	2 SECTIONS	2 SECTIONS	2 SECTIONS	2 SECTIONS	2 SECTIONS	2 SECTIONS	2 SECTIONS	2 SECTIONS	2 SECTIONS	2 SECTIONS
L	40000	160	2020'	81'-0" x 107'-0"	1 1/2 - 2	775'	750'	625'	2500'	1830'	3080'	2 SECTIONS	2 SECTIONS	2 SECTIONS	2 SECTIONS	2 SECTIONS	2 SECTIONS	2 SECTIONS	2 SECTIONS	2 SECTIONS	2 SECTIONS	2 SECTIONS	2 SECTIONS	2 SECTIONS	2 SECTIONS	2 SECTIONS	2 SECTIONS
M	40000	160	2020'	81'-0" x 107'-0"	1 1/2 - 2	775'	750'	625'	2500'	1830'	3080'	2 SECTIONS	2 SECTIONS	2 SECTIONS	2 SECTIONS	2 SECTIONS	2 SECTIONS	2 SECTIONS	2 SECTIONS	2 SECTIONS	2 SECTIONS	2 SECTIONS	2 SECTIONS	2 SECTIONS	2 SECTIONS	2 SECTIONS	2 SECTIONS
N	40000	160	2020'	81'-0" x 107'-0"	1 1/2 - 2	775'	750'	625'	2500'	1830'	3080'	2 SECTIONS	2 SECTIONS	2 SECTIONS	2 SECTIONS	2 SECTIONS	2 SECTIONS	2 SECTIONS	2 SECTIONS	2 SECTIONS	2 SECTIONS	2 SECTIONS	2 SECTIONS	2 SECTIONS	2 SECTIONS	2 SECTIONS	2 SECTIONS
O	40000	160	2020'	81'-0" x 107'-0"	1 1/2 - 2	775'	750'	625'	2500'	1830'	3080'	2 SECTIONS	2 SECTIONS	2 SECTIONS	2 SECTIONS	2 SECTIONS	2 SECTIONS	2 SECTIONS	2 SECTIONS	2 SECTIONS	2 SECTIONS	2 SECTIONS	2 SECTIONS	2 SECTIONS	2 SECTIONS	2 SECTIONS	2 SECTIONS
P	40000	160	2020'	81'-0" x 107'-0"	1 1/2 - 2	775'	750'	625'	2500'	1830'	3080'	2 SECTIONS	2 SECTIONS	2 SECTIONS	2 SECTIONS	2 SECTIONS	2 SECTIONS	2 SECTIONS	2 SECTIONS	2 SECTIONS	2 SECTIONS	2 SECTIONS	2 SECTIONS	2 SECTIONS	2 SECTIONS	2 SECTIONS	2 SECTIONS

Source: Manual of the Construction Division of the Army, Section C, Engineer Division, Washington, DC, 1919. 150.

Category: ADMINISTRATION

Type 1 a: Fire Stations

Description:

The fire station housed fire fighting equipment to protect military installations from the threat of fire. Building size varied depending on the size of the installation and type of fire fighting technology. Examples of fire stations include one- and two-story buildings. A characteristic architectural feature of all fire stations is the large door openings that accommodated the fire fighting apparatus, first wagons and later trucks. Fire stations constructed before 1917 contained hose towers that projected above the roof and were used to dry the cotton fire hoses. During the 1930s, hose drying areas were incorporated into the interior of the building, which eliminated the exterior towers. When electric dryers were installed, the need for the hose tower was eliminated entirely.

Evolution:

Fire stations evolved as a separate property type during the late nineteenth century and reflected the development fire fighting technology. At temporary cantonments, soldiers used buckets of water or sand to fight fires. By 1876, the Quartermaster Department provided fire extinguishers as part of general provisions.¹ The consolidation of troops into larger, more substantial installations during the 1880s and 1890s required the Quartermaster Department to plan for fire emergencies. With more buildings to protect, the Quartermaster Department acquired fire fighting equipment and designed buildings to house it. The earliest Quartermaster-standardized plans for a separate firehouse date from 1894.² These fire stations were small buildings with a hose tower and two major door openings. Larger installations often had two or more of these small firehouses to provide adequate protection in an era of fire fighting equipment drawn by horse or human power. A one-story firehouse contained only the fire fighting apparatus, while two-story buildings also contained personnel quarters for personnel on the upper floor.³ The two-story firehouse was constructed from the late nineteenth century through the 1930s.

In 1916, the Quartermaster Department issued a standardized plan that combined the functions of fire station and guardhouse.⁴ This combination became the prevalent design during the late 1920s and the 1930s. During the 1930s, the Army introduced motorized fire fighting equipment and consolidated fire stations at central locations on installations. Often the fire station commanded a prominent location at the junction of major streets. During the widespread

¹ David A. Clary, *These Relics of Barbarism: A History of Furniture in Barracks and Guardhouses of the United States Army, 1800-1880*, MSS, U.S. Department of the Interior, National Park Service, Harpers Ferry Center, West Virginia, 1983, 165-166.

² National Archives and Records Administration, Cartographic Branch, Record Group 77, Standard Plans of Army Post Buildings, 1891 - 1918, P.I. NM-19, Entry 411, Plan 98.

³ NARA, Cartographic Branch, RG 77, Standard Plans of Army Post Buildings, 1891 - 1918, Plan 232.

⁴ NARA, Cartographic Branch, RG 77, Standard Plans of Army Post Buildings, 1891 - 1918, Plan 421.

rebuilding of Army posts and airfields during the 1930s, the fire station became a major element of the overall installation plan and reflected the installation's architectural character.

Association:

Fire stations are associated with the development and modernization of permanent military installations, starting in the late nineteenth century. Fire stations located on installations established before the Civil War probably were added during the late nineteenth century. During the twentieth century, fire stations became a standard feature of military installations. Often fire station design reflects the military's adaptation of contemporary architectural styles to installation construction.

Fire stations are support facilities for an installation, and are not related directly to the installation mission. Fire stations generally are not associated with significant historical events and usually do not possess individual historical significance, but can be a contributing building to an historic district. If the building has a prominent location in the overall plan of the installation, it can be a major architectural element that contributes to the architectural character of the installation.

Integrity:

To possess the integrity necessary to convey its significance, a fire station should retain most of its original design, materials, workmanship, and setting from its period of construction. Character-defining features of fire stations include hose towers in pre-1917 buildings, wide door openings, original doors, and the overall pattern of openings. In addition, fire stations built as part of installation master plans, as was common during the 1930s, possess design features common to the architectural character of the installation that are important elements to the building's integrity. Typical alterations to this building type include infilling original doorways and replacement of original doors. In cases of subsequent additions or renovations, the building may have integrity if it has retained the majority of its character-defining features, particularly its setting in an overall plan, basic form, materials, and pattern of openings.

Fire House
Fort D.A. Russell (F.E. Warren AFB)
Photo Dated: 1909

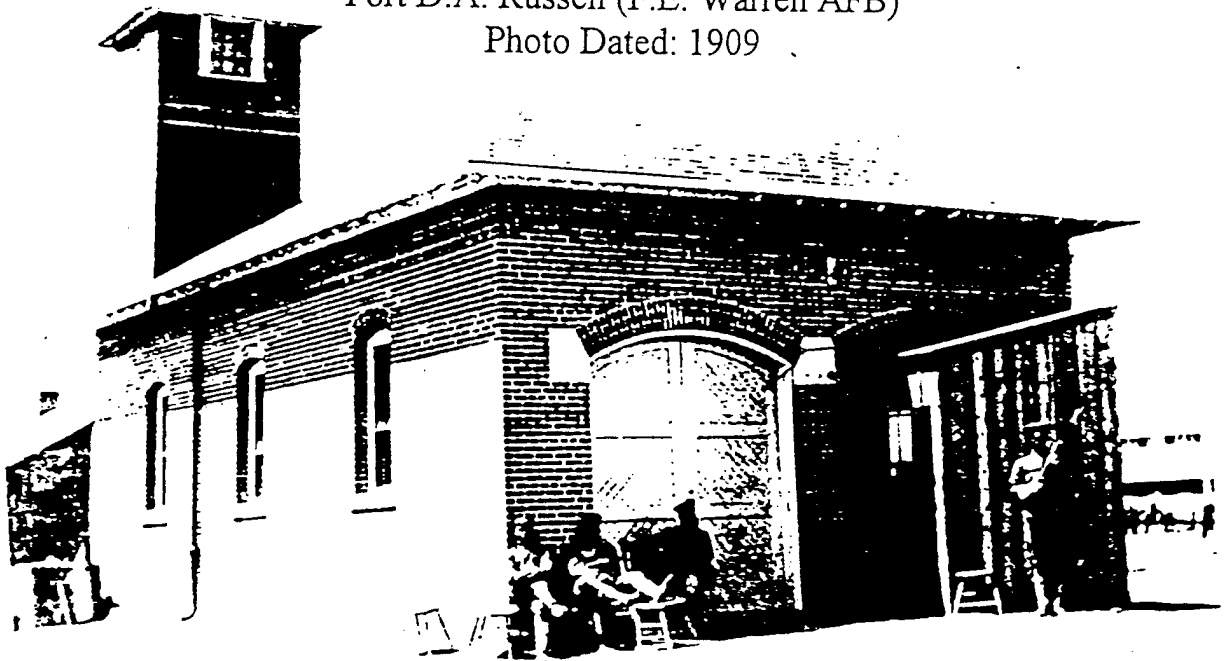

Category: ADMINISTRATION

Type 1 b: Guardhouses/Gatehouses/Sentry Boxes

Description

Guardhouses served as installation prisons and the office of the guard. Separate guardhouses were common components of Army posts. They were generally one story, rectangular buildings, often with a basement, and a large hipped roof. Gates, gatehouses, and sentry boxes are structures placed at major access points, often along roadways, to monitor the entrances to an installation; they usually are one-story buildings. Military prisons are discussed in a separate chapter in this volume.

Evolution:

The guardhouse evolved as a separate building type, notably at frontier posts, after the Army stopped the construction of walled or fortified installations during the mid-nineteenth century. Access at permanent masonry fortifications was controlled through sally ports or gates. Without surrounding fortifications, the free-standing guardhouse evolved to serve as the central point to guard the post and hold prisoners. Guardhouses contained the office of the Officer of the Guard, the guard room for men assigned to guard duty, and the prison. The guardhouse often was located near the main entrance to the post. At frontier forts, where the isolated post could be approached from many directions, the guardhouse was located apart from the main parade ground, often behind the barracks.

Proposed plans for a guardhouse published in 1860 unofficial Army regulations depict a one-story building with a horizontal emphasis similar to other one-story buildings suggested by these proposed regulations. Proposed plans designed by Quartermaster General Montgomery C. Meigs in 1872 illustrate a guardhouse with two separate portions joined together by a sally port. No examples of Meigs' standardized guardhouse design were located during the course of this study.⁵

The typical guardhouse constructed during the late nineteenth century was a one-story, square or rectangular building with a hipped roof and a full-facade veranda. Guardhouses without basements sometimes were constructed as imposing two-story buildings. During the 1880s, the basic guardhouse design incorporated a porch under the principal roof, dormer windows, and spindle woodwork that echoed the decorative features popular in late Victorian designs.

At the beginning of the twentieth century, the guardhouse retained the same basic shape as those of earlier times, but Colonial Revival details replaced the earlier Victorian-era details. In general, the size of the building increased as the sizes of individual installations increased.⁶

⁵ War Department, *Regulations Concerning Barracks and Quarters for the Army of the United States, 1860*. Washington, DC, George W. Bowman, 1861, 4; War Department, *Report of the Quartermaster General*, Washington, DC, Government Printing Office, 1872, 280.

⁶ NARA, Cartographic Branch, RG 77, Standard Plans of Army Post Buildings, 1891 - 1918, Plan 421.

By the 1930s, the guardhouse served primarily as a detainment center and was located near the center of the installation. The Army during this period often combined guardhouses and fire stations in one building. The earliest Quartermaster-standardized plan combining the two functions in one building is dated 1916.⁷

When guardhouses were combined with fire stations, separate gatehouses and sentry boxes were constructed to monitor the entrances to an installation. The earliest Quartermaster standardized plan for a gate lodge appeared in 1911.⁸ During the late 1920s and 1930s, gatehouses proliferated as automobile traffic increased. Gatehouses generally were small, unassuming buildings constructed in the installation's prevalent building style, generally Georgian Colonial Revival or Spanish Colonial Revival.

Association:

Guardhouses, gatehouses, and sentry boxes are associated directly with the development of military installations after the Civil War and are minor installation building types. Their importance to the overall installation plan depends on their location and architectural prominence. If situated in a central location or along a defining boundary, these buildings can contribute to an historic district. Isolated sentry posts or guardhouses may not possess important associations with historic events or trends, but they may be a contributing element in a discontinuous historic district. If they retain a high degree of integrity, they may embody the distinctive characteristics of the building type.

Integrity:

To possess the integrity necessary to contribute to an historic district or to convey its individual significance, guardhouses and gatehouses should retain most of their original design, materials, workmanship, and setting from the period of their construction. Where buildings have undergone subsequent additions, renovations, or removal of architectural elements, the buildings still can possess integrity if they retain the majority of their historic features, such as materials, basic form, roof shape, and porch.

⁷ NARA, Cartographic Branch, RG 77, Standard Plans of Army Post Buildings, 1891 - 1918, Plan 296.

⁸ NARA, Cartographic Branch, RG 77, Standard Plans of Army Post Buildings, 1891 - 1918.



1911 Guard House at (Fort D.A. Russell) F.E. Warren AFB, Wyoming

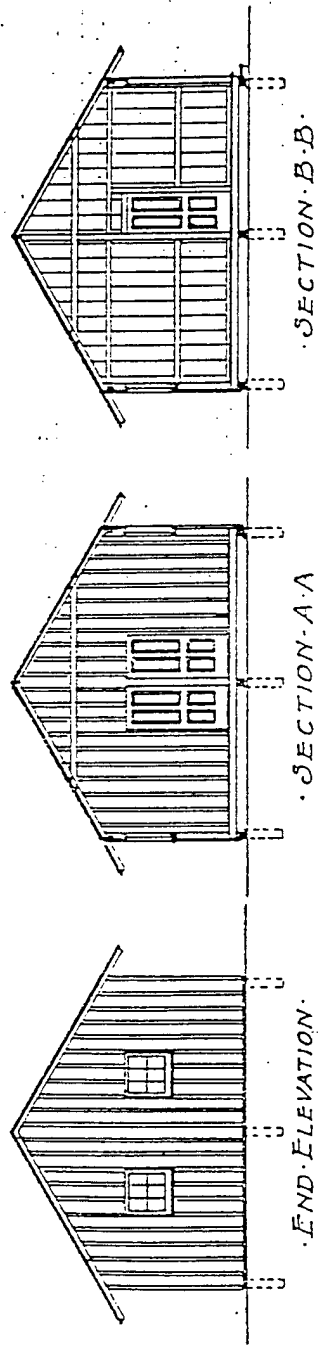

NOTE:

In both the 56'-0" and 63'-0" buildings the extra length is put in the prisoners room, making it 28'-0" and 35'-0" respectively. All partitions extend to roof.

GUARD HOUSE

Scale in Feet.

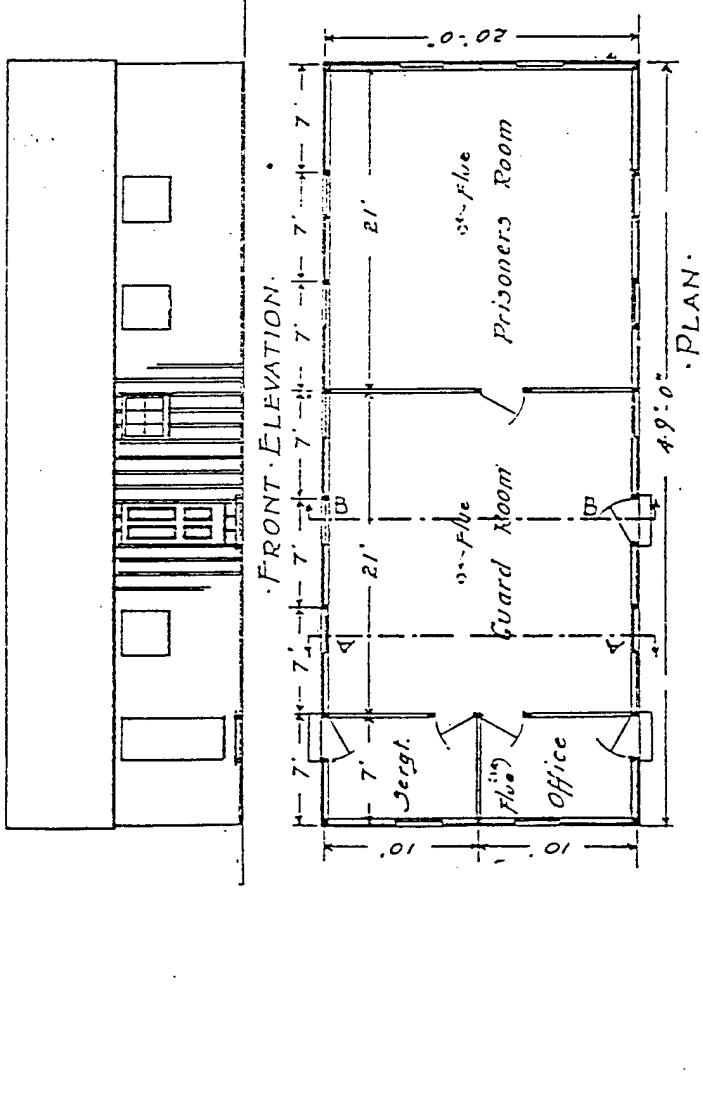

TEMPORARY BUILDINGS
FOR
MOBILIZATION CAMPS

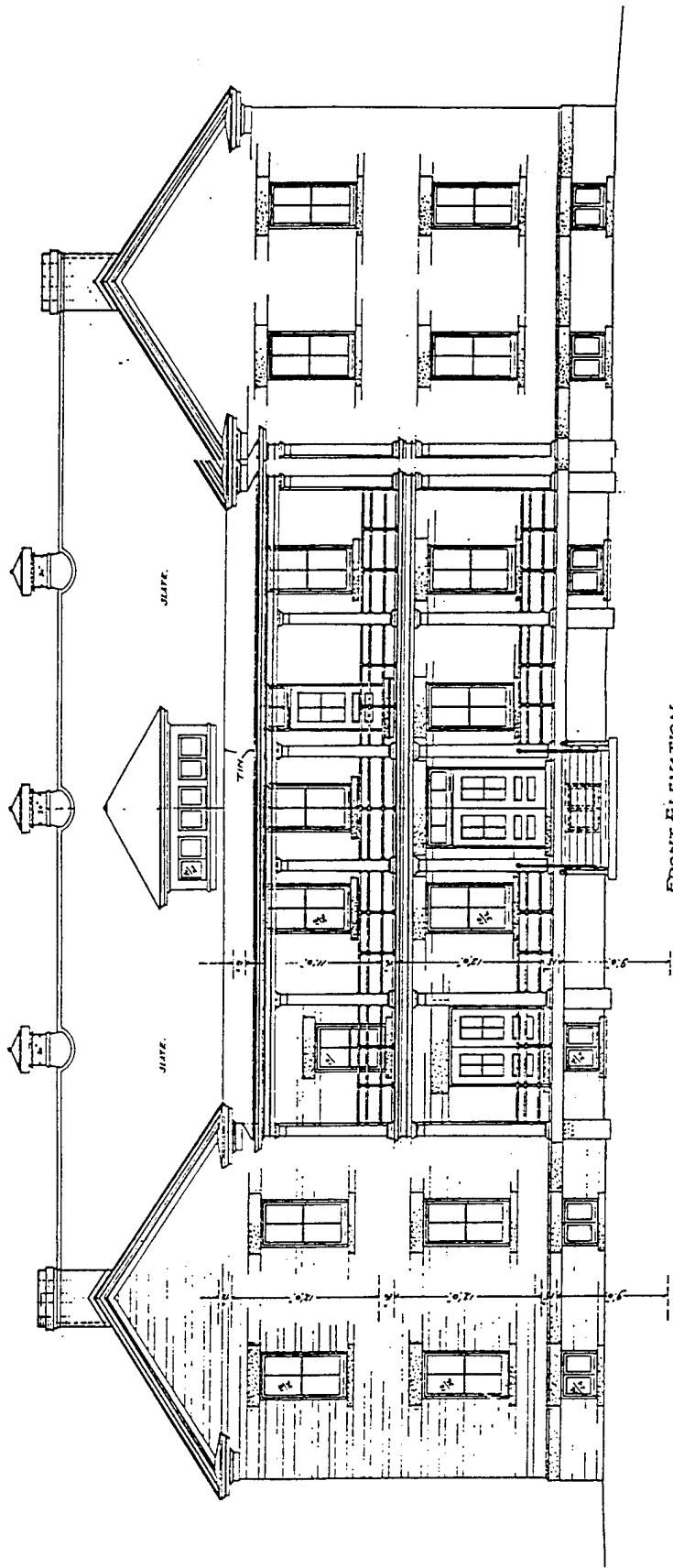

FRONT ELEVATION.
SCALE 1/4 inch.

U File A13-9
 ARTILLERY GUARD HOUSE.
 PORTLAND, ME. AND CAMP CO., ME. 1908.
 JOHN H. BAKER.
 NO 408.06.C11

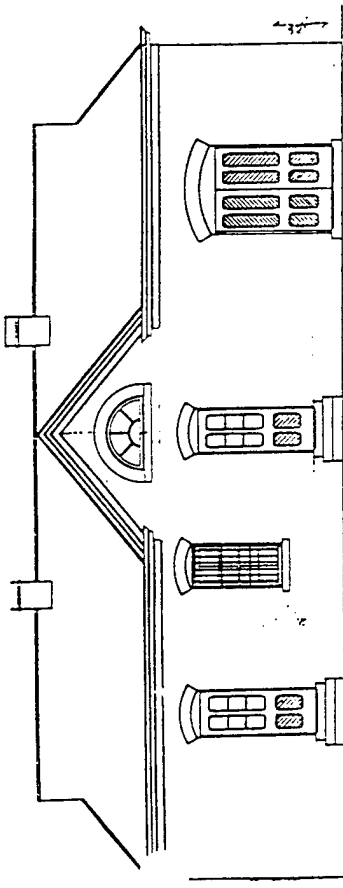

Elevation South side.

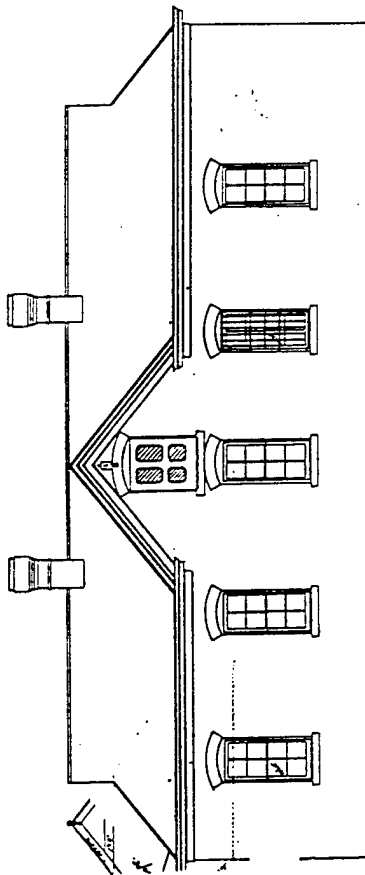

Elevation North side.

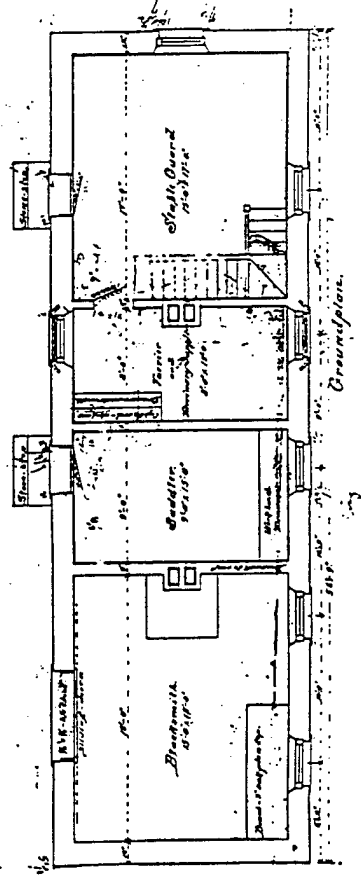

Ground plan.

Plan, Elevations & Section
of
County Stable Guard Building
at
Fort Riley, Kansas.
Scale 1/4" = 1'

Contracting & Architectural Office
1512 1/2 W. 10th St., Kansas City, Mo.
George Rubben
Captain U.S.A. & U.S.A. Army
In Charge of Construction

Detail for Joys.
Scale 1/2" = 1'

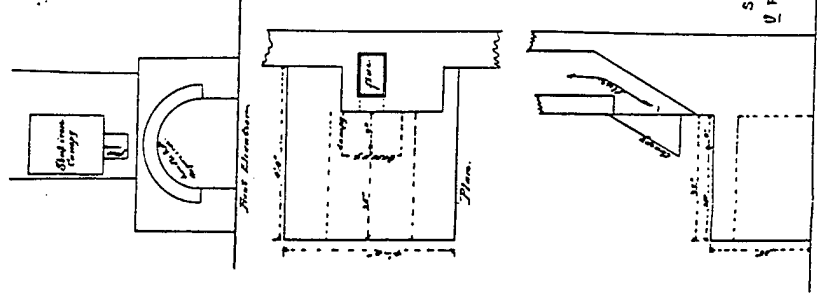

Sheet - 73
File A14-1

Side Elevation.

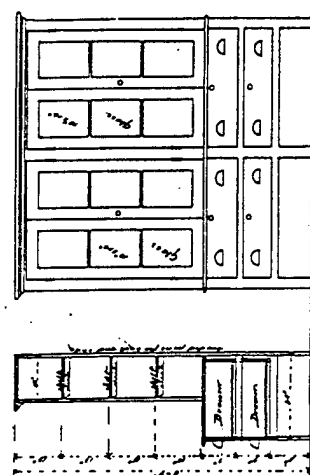

Section of Driveway for Driveway Supply.
Scale 1/2" = 1'

Elevation.

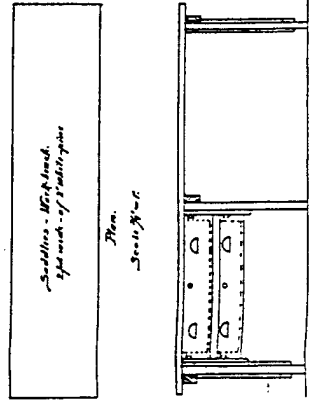

Saddles - Workbench.
Scale 1/2" = 1'

Elevation.

Category: ADMINISTRATION

Type 1 c: Headquarters Buildings, Administration Buildings, and Office Buildings

Description:

The headquarters building was the main office building of the installation and represented its administrative center. The administration building generally was placed in a prominent location that reflected its position as the center of command. At nineteenth- and early twentieth-century Army posts, the headquarters building was built facing the parade ground. The headquarters building usually was among the most elaborate buildings at permanent military installations and often exhibited high-style architectural design typical of its period of construction.

Evolution:

Early and mid nineteenth-century administration buildings on Army posts contained multiple uses. The unofficial Army regulations published in 1860 recommended that administration buildings contained one office for the commanding officer, an office for other staff, a courtroom, and a library. The 1860 regulations depict a small, one-story administration building constructed of locally available materials with little architectural adornment.⁹

When the Army consolidated troops at larger installations during the 1880s and 1890s, the administration building increased in size to accommodate more administrative functions. The headquarters building reflected the Army's permanent presence in a locality. The building generally was located in a prominent position overlooking the parade ground. The architectural character of the building matched contemporary architectural design and embodied the general architectural character of the installation.

The Quartermaster Department developed standardized plans for administration buildings for these new permanent installations. During the 1880s and early 1890s, the Quartermaster Department designed administration buildings using the popular Victorian styles. In 1894, the Quartermaster Department introduced Colonial Revival and Classical Revival designs for administration buildings. The popularity of Colonial Revival and Classical Revival continued until 1940. Some exceptions to the Georgian Colonial Revival also were built. In 1910, the Quartermaster Department issued a Spanish Colonial Revival design for administration buildings for use in the Southwest.¹⁰

During the twentieth century, administration buildings continued as multiple-use structures and grew in size to accommodate the oversight of larger installations. The required staff offices increased to include separate offices for a post adjutant, a sergeant major, and several clerks. Additional rooms were added to contain specific functions, including a records room and a court-

⁹ War Department, *Regulations Concerning Barracks and Quarters for the Army of the United States*, 1860, 4.

¹⁰ NARA, Cartographic Branch, RG 77, Standard Plans of Army Post Buildings, 1891 - 1918, Plans 76, 94, 99, 122, 169, 392.

martial room. The second story included a variety of other uses, including library, school room, reading room, or assembly hall. Quartermaster standardized plans dated 1905 show the introduction of post office. In 1909, telegraph and telephone rooms were included in the administration building. Basements were used for storage rooms and other support rooms.¹¹

The consolidation of troops on larger installations led to multiple headquarters buildings at posts. During the early and mid-nineteenth century, each post usually served a single mission. When the Army assigned troops with different missions to one installation, they often constructed the equivalent of two separate posts side by side with separate facilities that included separate administration buildings. At Ft. Riley, for instance, the cavalry post and artillery post each had a headquarters building.

During the late nineteenth century, some Army installations housed two command structures: post-level and regional- or district level. At Ft. Leavenworth, one building was built to serve as post headquarters, while a former ordnance building was adapted for the offices of the Department of the Missouri. After the reorganization of the Army at the beginning of the twentieth century, administration buildings were designed purposely to contain offices for overlapping levels of jurisdiction, such as the district administration and the post administration. The increasing volume of administrative duties required the enlargement of administration buildings.

By the 1930s, the expansion of multiple levels of administrative duties again resulted in the construction of separate buildings to house the organizational hierarchy. At Barksdale AFB, for example, separate office buildings were constructed for the post and group headquarters.

Administration buildings constructed as part of the wave of new construction authorized by Public Law No. 45, enacted in 1926, followed Quartermaster standardized plans for Georgian Colonial Revival, Spanish Colonial Revival, and French Colonial Revival architectural designs. The buildings no longer faced a central parade ground, but commanded a prominent position within a general master plan that divided the post into functional areas connected by a planned street pattern. Room for individuality still remained; the headquarters building at Randolph AFB was designed specifically for the Texas training field and came to symbolize 1930s Army aviation.

The growth of administrative functions in the years before the Second World War resulted in the construction of additional building types, as headquarters buildings no longer could accommodate the many offices required to administer a post. The Quartermaster Department designed separate buildings for specific functions including recreation, post office, and communications. Construction of new building types to contain these other functions began during the first decade of the twentieth century and continued through the 1930s, leaving the headquarters building to house only offices. This specialization contributed to the growth in size and complexity of installations.

¹¹ NARA, Cartographic Branch, RG 77, Standard Plans of Army Post Buildings, 1891 - 1918, Plans 99-C, 99-D, 254.

Association:

The headquarters building of an installation may be individually eligible for the National Register or may be a major contributing building to an historic district. The headquarters building is a major building type that may possess significance because of historical associations with significant events or individuals or because of architectural merit. As the administrative center, the headquarters building is associated closely with the historical significance of the installation and its role in U.S. history. Examples of this property type also may represent the work of significant architects, embody the distinctive characteristics of a type or period of construction, or have artistic merit. Headquarters buildings often displayed high-style architectural design reflecting their periods of construction; they were among the most elaborately ornamented buildings constructed at permanent installations and were placed at a prominent location in an overall installation plan, particularly at installations that were built according to a master plan over a short span of time.

Integrity:

To possess the integrity necessary to convey its significance, a headquarters building should retain most of its original design, materials, workmanship, and setting from its period of significance. The period of significance may extend over the many years that the headquarters building served as the administrative and symbolic center of the installation. Modifications to the building may have acquired significance if they are related to the building's period of significance. As a result of the increased size and complexity of administrative functions, few pre-1940 headquarters buildings continue to serve as the current installation or activity headquarters. Where subsequent additions or renovations have modified or removed architectural elements, the building still can possess sufficient integrity if it retains the majority of the features that compose its design, including massing, spatial relationships, proportion, pattern of openings, materials, and ornamentation.



1900 Post Headquarters at (Fort D.A. Russell) F.E. Warren AFB, Wyoming



1905-06 Administration Headquarters at Fort Worden, WA

NOTE: All partitions extend to roof.

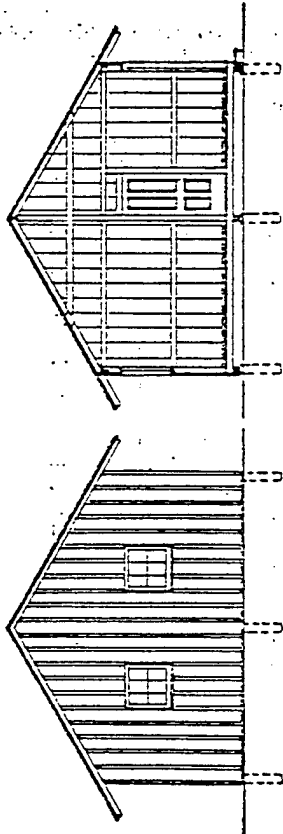

SECTION.

END ELEVATION.

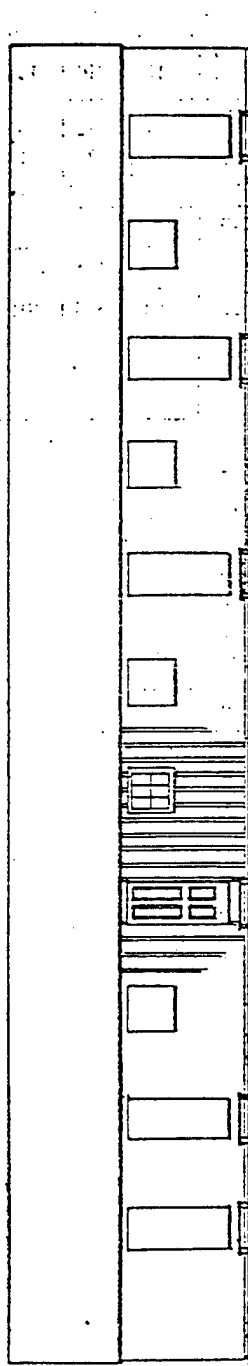

FRONT ELEVATION.

ADMINISTRATION BUILDING.

Scale - in. Feet.
0 5 10

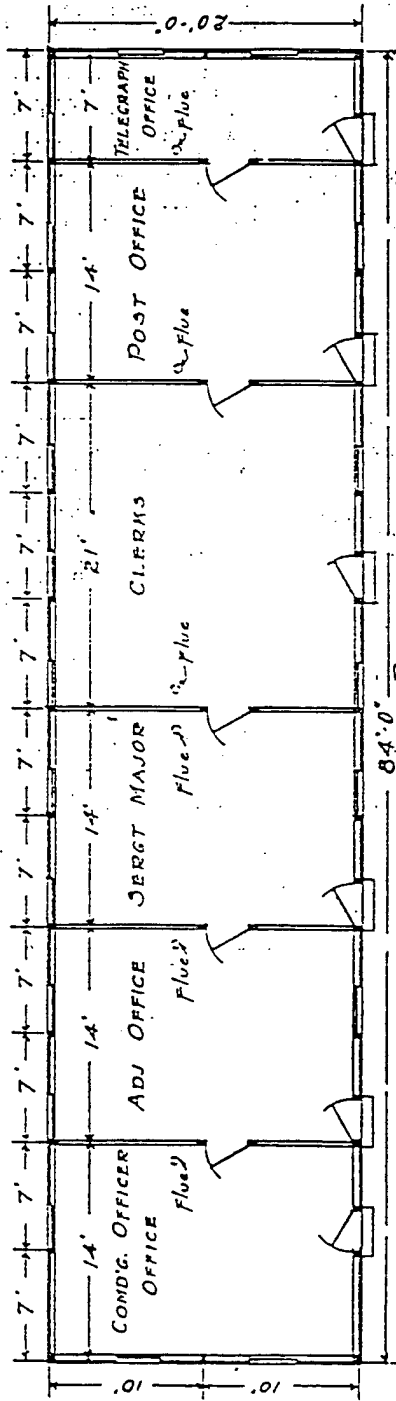

TEMPORARY BUILDINGS.
FOR
MOBILIZATION CAMPS.

84'-0" PLAN.

APPENDIX No. 10-10.

16-10

Proposed Administration Building

remodeled from present hospital

at
Fort Riley, Kans.

Designed by Capt Geo. F. Bond.
A. Q. M. U.S. A.

Wm. Goings, Archt. *Scale 1/8" = 1'*

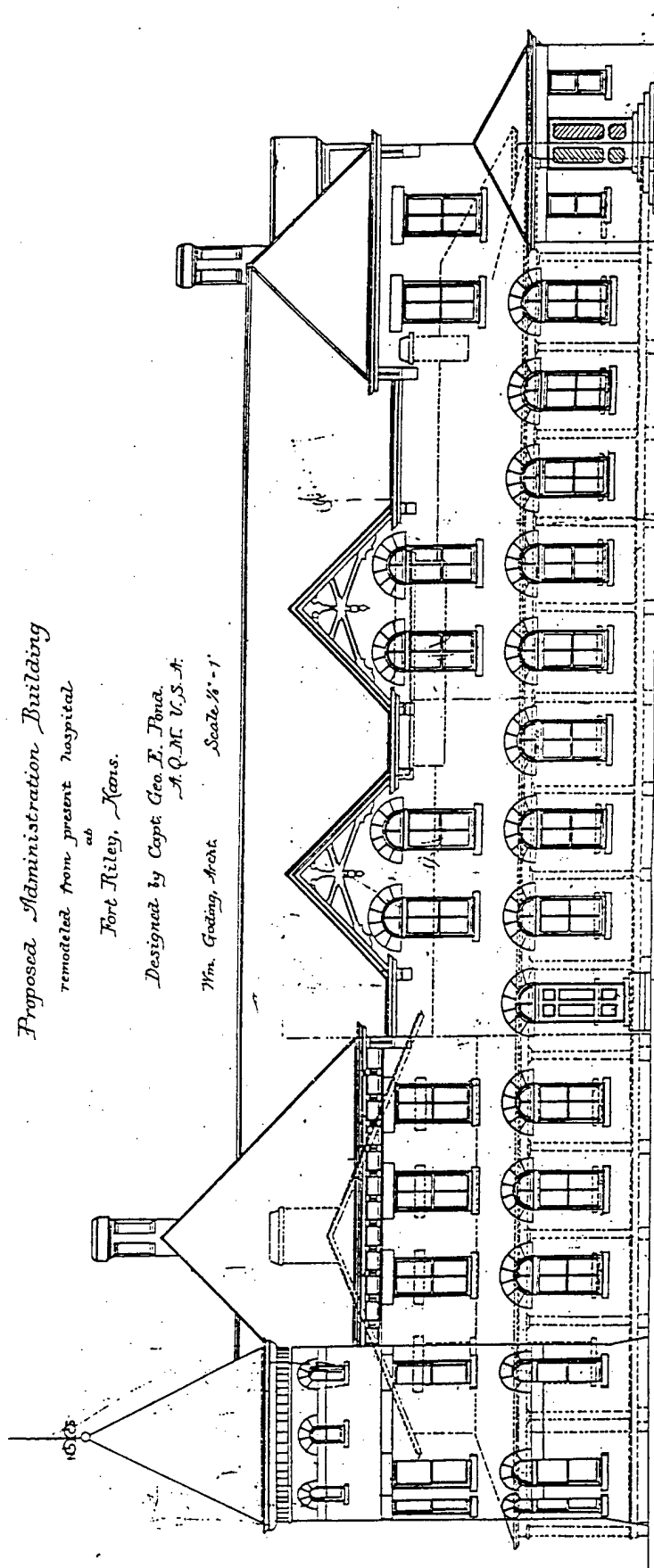

West Elevation
Scale 1/8" = 1'

Sheet - 1/6
V File A 13-2

h0 205_09.cit 18295.PDF.CIT

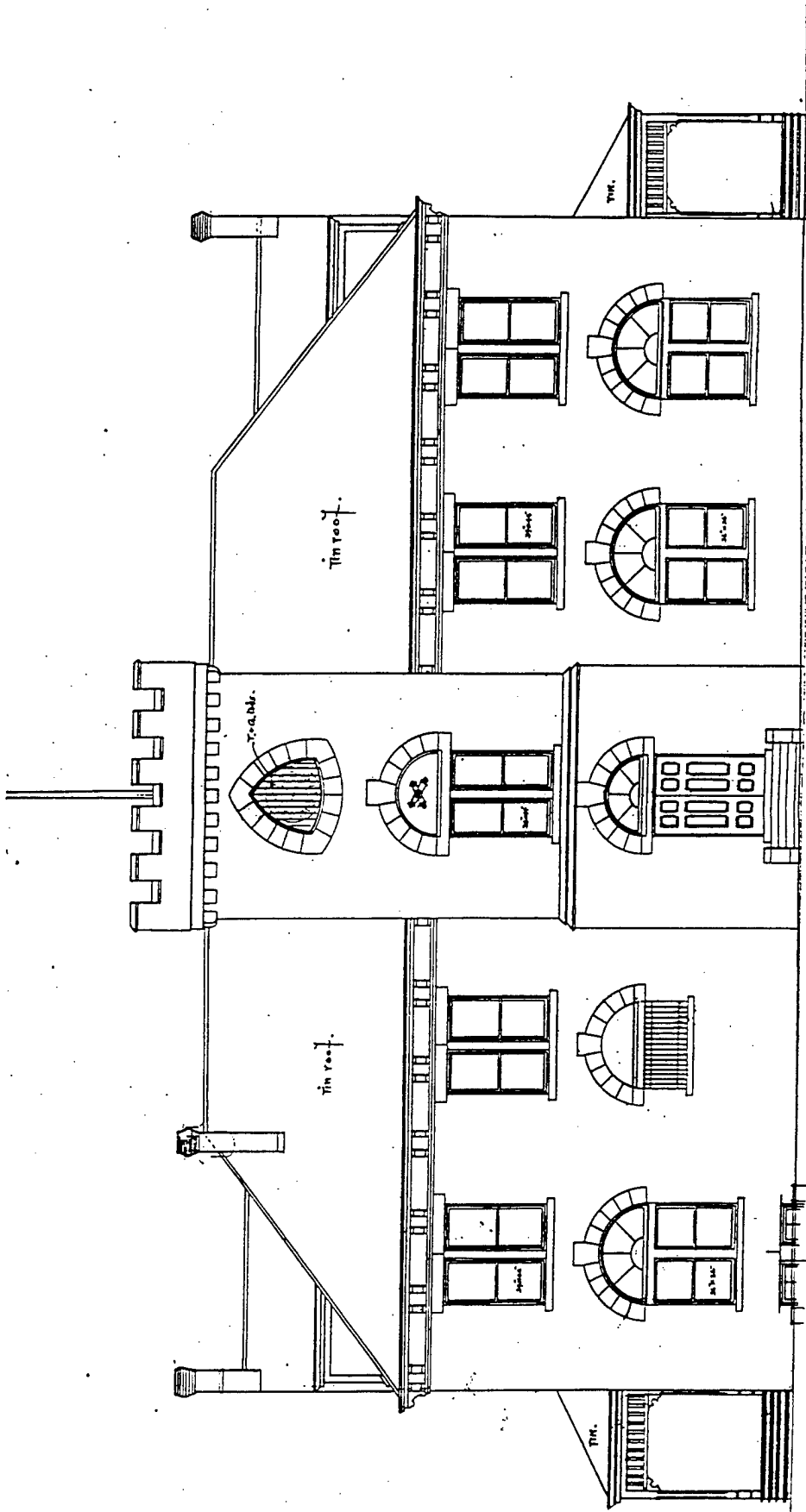

Front Elevation

Scale 1/4" = 1'

ADMINISTRATION BUILDING
 Artillery Post, Fort Riley, Kansas
 Designed by
 CAPT. GEO. E. POND, A.Q.M., U.S.A.
 1/2887

U File A13-3.

H0403_02.CIT

403

h0 403_02.cit

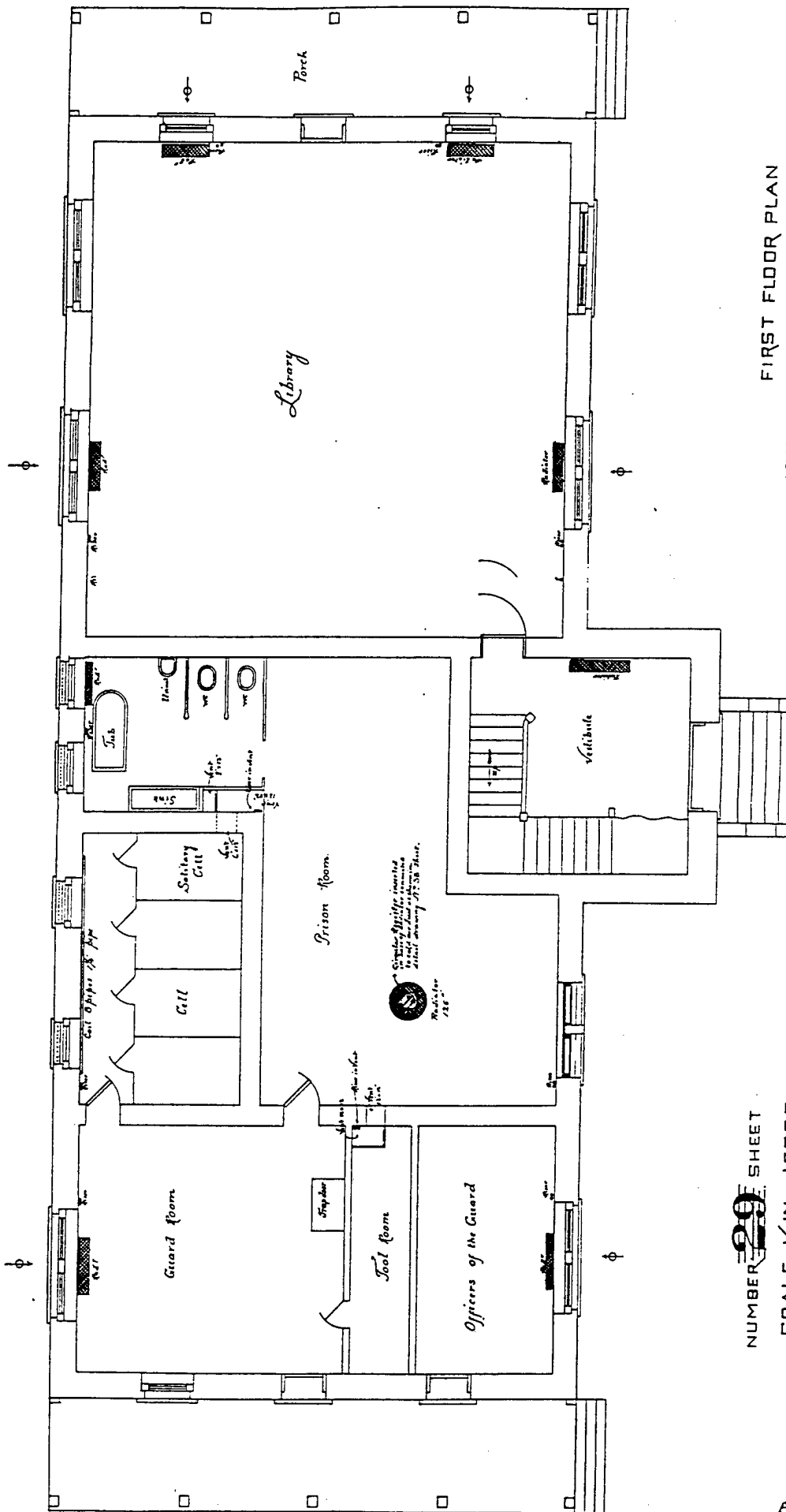

FIRST FLOOR PLAN
 ARTILLERY ADMINISTRATION BUILDING
 FORT RILEY KANSAS
 CLASS 'G'

Sheet- $\frac{3}{4}$
 U File A18-3
 h0 403.29.ci

NUMBER **29** SHEET
 SCALE $\frac{1}{4}$ " = 1' FOOT
 HEIGHT OF CEILING 14'3"
 Notes: —○— denotes air vents as shown
 on Detail Sheet 74-39

RADIATION
 728°
 Circular symbol inserted
 in detail drawing of 75-58 there.

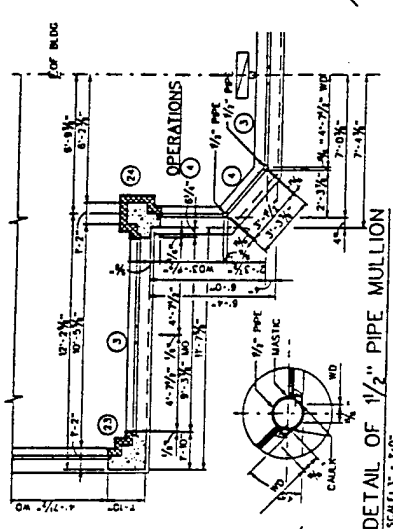

DETAIL OF OPERATIONS ROOM FRONT WINDOW COMMUNICATIONS & APARATUS ROOM WINDOWS - SAME
SCALE: 1/4" = 1'-0"

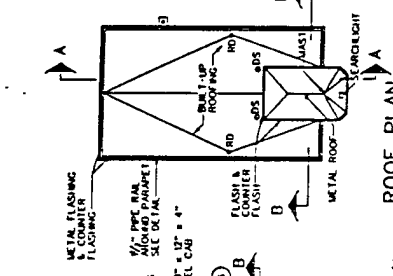

THIRD FLOOR PLAN
SCALE: 1/4" = 1'-0"

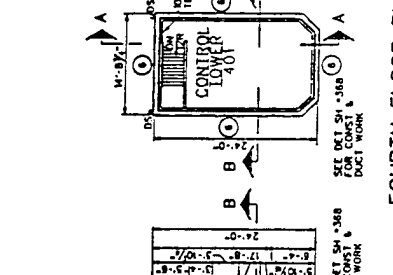

FOURTH FLOOR PLAN
SCALE: 1/4" = 1'-0"

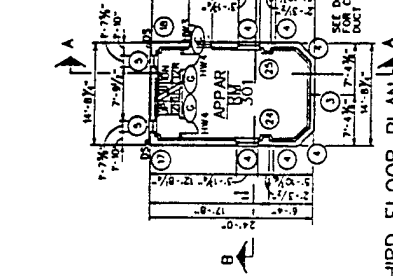

ROOF PLAN
SCALE: 1/4" = 1'-0"



PLOT PLAN
SCALE: 1/4" = 1'-0"

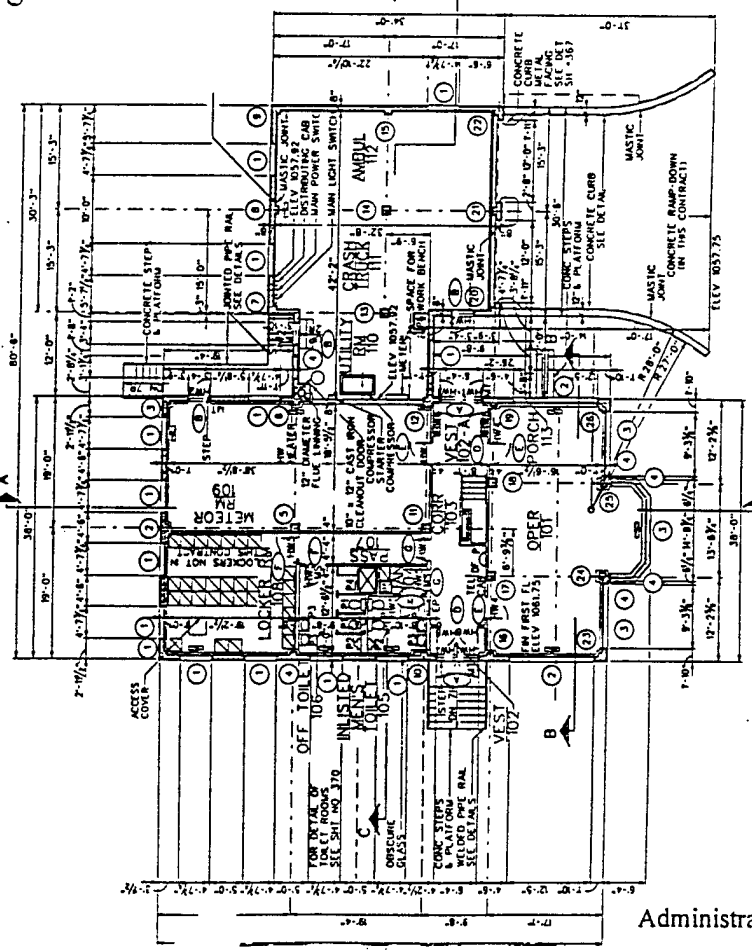

FIRST FLOOR PLAN
SCALE: 1/4" = 1'-0"

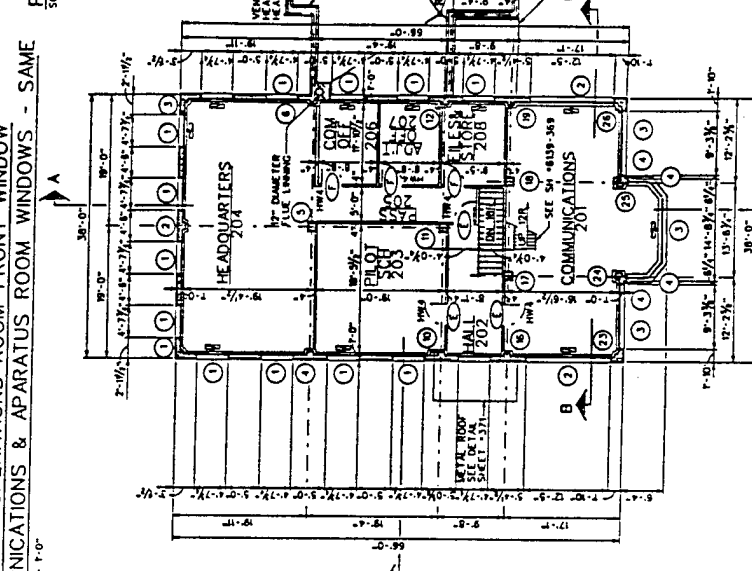

SECOND FLOOR PLAN
SCALE: 1/4" = 1'-0"

CONSTRUCTION DIVISION GENERAL
OFFICE OF THE QUARTERMASTER
MARSHALL FIELD
KANSAS
OPERATIONS BUILDING
FLOOR PLANS & PLOT PLAN
DATE
SEPT 20, 1940
PLAN NUMBER
613-1855
M0743 0100H

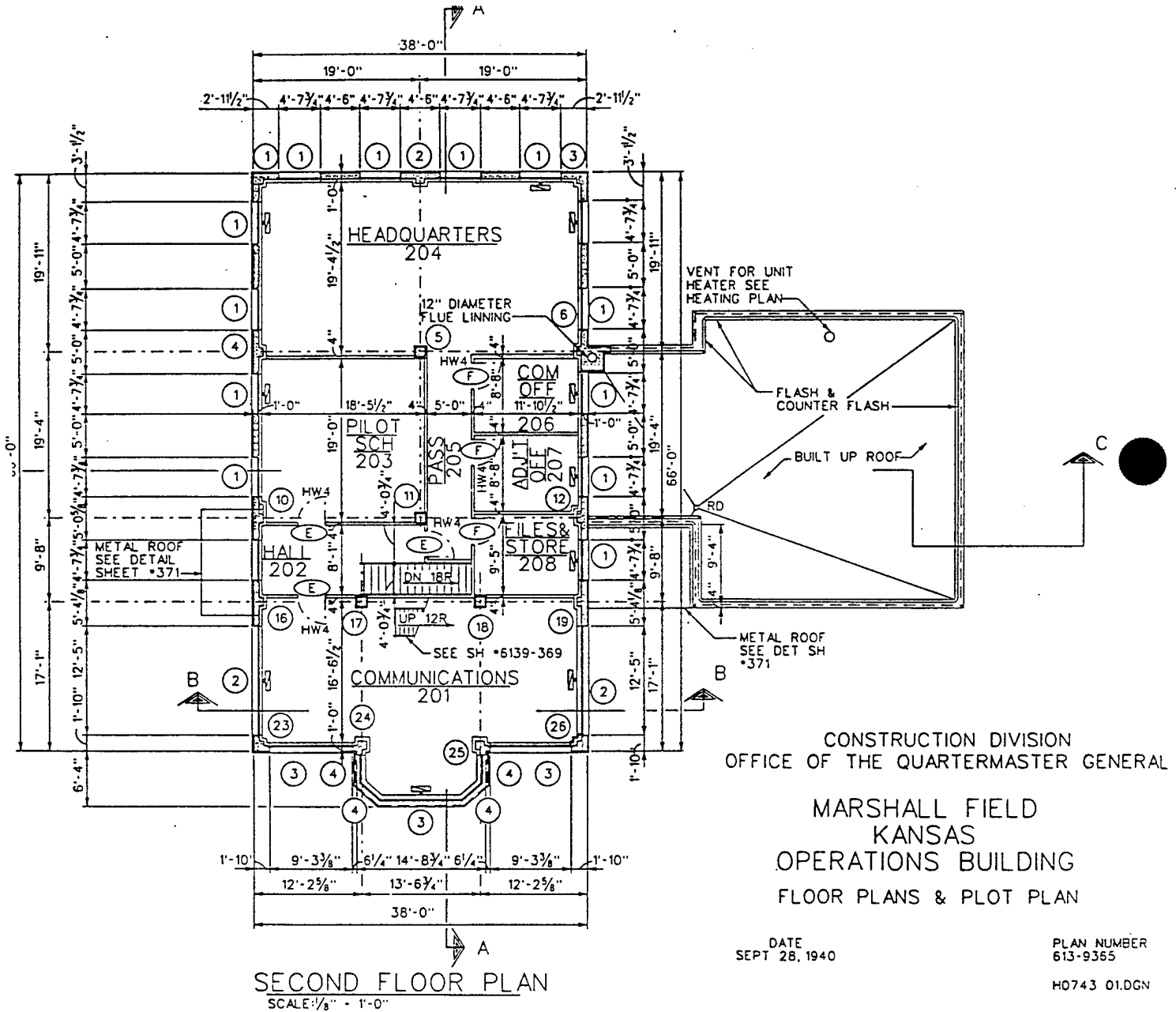

Category: ADMINISTRATION

Type 1 d: Post Offices

Description:

Military post offices received and distributed installation mail. Until the early 1900s, most installation post offices were housed within the headquarters or administration building. Post offices constructed before 1940 generally were one-story buildings with minimal stylistic references.

Evolution:

Separate buildings to house communications functions did not appear at Army installations until the twentieth century. Until that time, the central administration building could handle the volume of mail received on an installation. Mail was delivered to the main headquarters building and distributed by hand to the troops. During the twentieth century, the post administration grew more complex as the installation expanded, and the function of handling mail was shifted out of the administration building into a specialized post office building type. In 1905, the Quartermaster Department included a separate room for use as a post office in standardized plans for administration buildings. In 1906, the Quartermaster Department issued a standardized plan for a post/telegraph office. In 1907, a separate Quartermaster standardized plan was issued for a post office.¹² Despite the post office standardized plan, the construction of separate post office buildings was not widespread, even during the 1930s construction era. In some cases, the post office was combined with another use, for example the combined post office-Masonic Hall at Ft. Leavenworth, Kansas.

Association:

Post office buildings are associated with the growth of administration needs on military installations after the turn of the century. A post office was one of a number of support facilities constructed to house the expanding administrative functions of an installation. Post offices located on nineteenth-century installations were added to the installation. The post office architecture reflected the military's adaptation of contemporary architectural styles to installation construction.

As a support facility for an installation, a post office generally does not possess individual significance. It can be a contributing element in an historic district when it is part of a concentration of historically significant buildings and retains integrity. In other cases, the building may be isolated from a potential historic district, and then should be evaluated for its individual significance.

¹² NARA, Cartographic Branch, RG 77, Standard Plans of Army Post Buildings, 1891-1919, Plans 99-C, 177, 177A.

Integrity:

To possess sufficient integrity to be considered a contributing building in an historic district, post office buildings should retain most of their original design, materials, workmanship, and setting from the period of significance of the historic district. In the case of subsequent additions or renovations, the building still may possess integrity if it retains the majority of its character-defining features, including overall form, materials, proportion of openings, relationship to its setting, and architectural details.



1890 s Post Office at Fort MonroE, VA

HEATING		3 SCHEDULE		DUCT SIZES	
SYSTEM	TYPE	PO-1	PO-1	TYPE	PO-1
1	1	1	1	A	2 1/2" x 3 1/2"
2	2	2	2	B	2 1/2" x 2 1/2"
3	3	3	3	C	2 1/2" x 2 1/2"
4	4	4	4	D	2 1/2" x 2 1/2"
5	5	5	5	E	2 1/2" x 2 1/2"
6	6	6	6	F	2 1/2" x 2 1/2"
7	7	7	7	G	2 1/2" x 2 1/2"
8	8	8	8	H	2 1/2" x 2 1/2"
9	9	9	9	I	2 1/2" x 2 1/2"
10	10	10	10	J	2 1/2" x 2 1/2"
11	11	11	11	K	2 1/2" x 2 1/2"
12	12	12	12	L	2 1/2" x 2 1/2"
13	13	13	13	M	2 1/2" x 2 1/2"
14	14	14	14	N	2 1/2" x 2 1/2"
15	15	15	15	O	2 1/2" x 2 1/2"
16	16	16	16	P	2 1/2" x 2 1/2"
17	17	17	17	Q	2 1/2" x 2 1/2"
18	18	18	18	R	2 1/2" x 2 1/2"
19	19	19	19	S	2 1/2" x 2 1/2"
20	20	20	20	T	2 1/2" x 2 1/2"
21	21	21	21	U	2 1/2" x 2 1/2"
22	22	22	22	V	2 1/2" x 2 1/2"
23	23	23	23	W	2 1/2" x 2 1/2"
24	24	24	24	X	2 1/2" x 2 1/2"
25	25	25	25	Y	2 1/2" x 2 1/2"
26	26	26	26	Z	2 1/2" x 2 1/2"

SYSTEM	TYPE	PO-1	PO-1
1	1	1	1
2	2	2	2
3	3	3	3
4	4	4	4
5	5	5	5
6	6	6	6
7	7	7	7
8	8	8	8
9	9	9	9
10	10	10	10
11	11	11	11
12	12	12	12
13	13	13	13
14	14	14	14
15	15	15	15
16	16	16	16
17	17	17	17
18	18	18	18
19	19	19	19
20	20	20	20
21	21	21	21
22	22	22	22
23	23	23	23
24	24	24	24
25	25	25	25
26	26	26	26
27	27	27	27
28	28	28	28
29	29	29	29
30	30	30	30

LEGEND
 1. V - Vertical
 2. H - Horizontal
 3. D - Diagonal
 4. S - Slope
 5. T - Taper
 6. R - Radius
 7. C - Chamfer
 8. F - Fillet
 9. G - Groove
 10. M - Miter
 11. N - Notch
 12. O - Offset
 13. P - Projection
 14. Q - Quarter
 15. R - Round
 16. S - Square
 17. T - Taper
 18. U - Undercut
 19. V - Vertical
 20. W - Width
 21. X - Extension
 22. Y - Yield
 23. Z - Zone
 24. AA - Area
 25. BB - Base
 26. CC - Cap
 27. DD - Depth
 28. EE - End
 29. FF - Face
 30. GG - Gage
 31. HH - Hole
 32. II - Inset
 33. JJ - Joint
 34. KK - Key
 35. LL - Lead
 36. MM - Material
 37. NN - Note
 38. OO - Order
 39. PP - Part
 40. QQ - Quantity
 41. RR - Reference
 42. SS - Section
 43. TT - Tolerance
 44. UU - Use
 45. VV - View
 46. WW - Weight
 47. XX - X-ray
 48. YY - Yield
 49. ZZ - Zone

NOTES
 1. All dimensions are in feet and inches unless otherwise specified.
 2. All work shall be in accordance with the specifications and standards of the Department of the Army.
 3. All materials shall be of the highest quality and shall be tested and certified by the manufacturer.
 4. All work shall be done in accordance with the approved shop drawings and specifications.
 5. All work shall be done in accordance with the approved construction schedule and program.
 6. All work shall be done in accordance with the approved safety plan and procedures.
 7. All work shall be done in accordance with the approved environmental protection plan and procedures.
 8. All work shall be done in accordance with the approved quality control plan and procedures.
 9. All work shall be done in accordance with the approved record keeping plan and procedures.
 10. All work shall be done in accordance with the approved communication plan and procedures.

700-218
 700-221
 700-222
 700-223
 700-224
 700-225
 700-226
 700-227
 700-228
 700-229
 700-230
 700-231
 700-232
 700-233
 700-234
 700-235
 700-236
 700-237
 700-238
 700-239
 700-240
 700-241
 700-242
 700-243
 700-244
 700-245
 700-246
 700-247
 700-248
 700-249
 700-250

SCALE
 1" = 10'-0"
 1/2" = 10'-0"
 3/4" = 10'-0"
 1/4" = 10'-0"

CONSTRUCTION DIVISION
 MOBILIZATION BUILDINGS
 POST OFFICE
 TYPE - PO-1

OFFICE OF THE QUARTERMASTER GENERAL

700-298

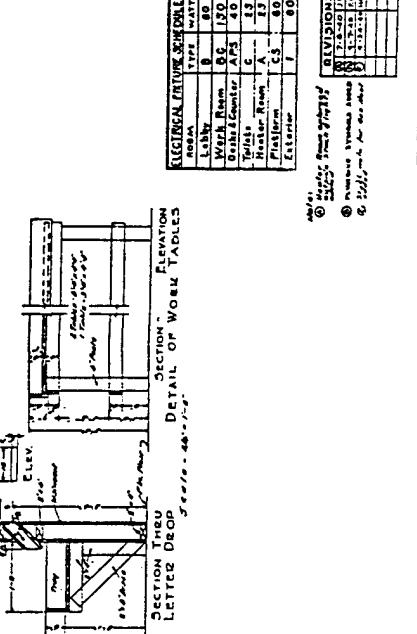
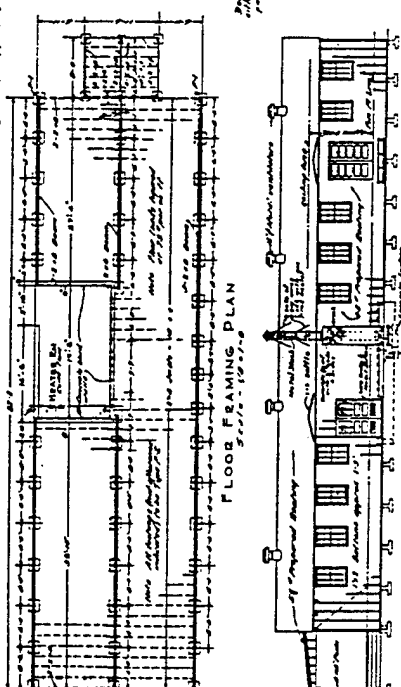
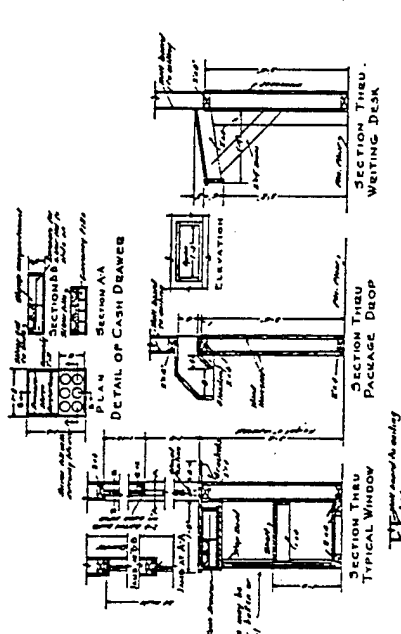
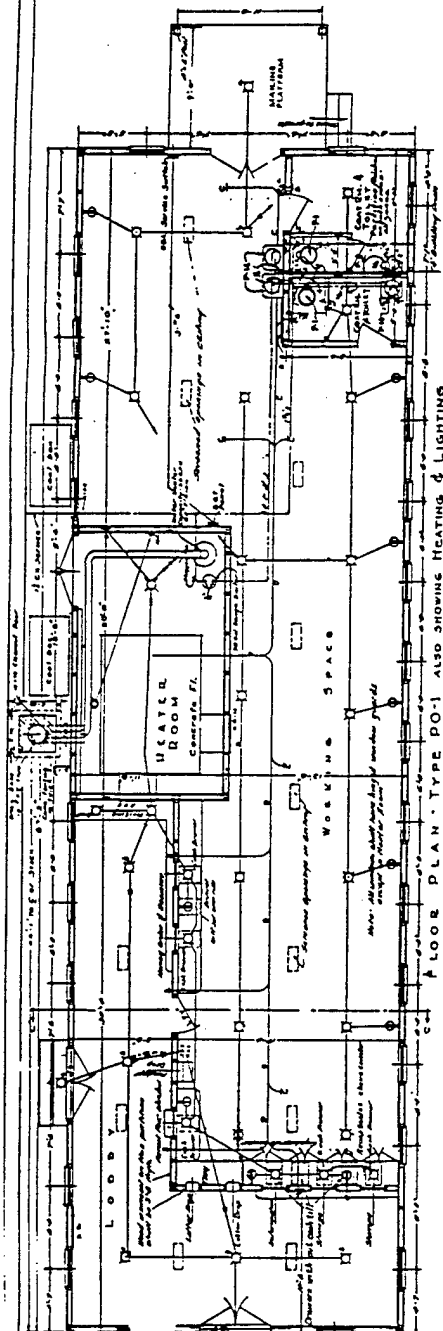

REVISION	DATE	BY	DESCRIPTION
1	10/1/50	J. H. [unclear]	Initial design
2	10/15/50	J. H. [unclear]	Revised design
3	10/20/50	J. H. [unclear]	Final design

Category: COMMUNICATIONS

Type 2 a: Radio Buildings

Description:

Military communications buildings fall into two categories: those that served basic communications needs on and between installations, such as telephone and telegraph offices, radio buildings, and radio control towers; and those that housed the communications facilities of specialized activities or branches, such as Navy radio stations or Army Signal Corps posts or detachments. Radio buildings constructed to support installation communications needs were generally small, one-story buildings with minimal stylistic references. Installations with specific communications missions had a communications complex of radio tower, transmitting station, housing, and support buildings. In all cases, radio buildings were located at a distance from a main cantonment or urban area so that radio operators received minimal disturbances in sending and receiving messages.

Evolution:

Radio buildings followed the development of radio technology during the early twentieth century. In 1906, the Signal Corps began to experiment with wireless telegraph. During World War I, the Army experimented with radio, and continued to develop the military application of radio after the war. In 1916, the Quartermaster Department issued a plan for a one-story radio station that included a power room, passage, and operator room.¹ During the 1930s, the Quartermaster Corps developed a standardized plan for radio buildings. The one-story, T-shaped building became a typical feature at Army and Army Air Corps installations.

Radio buildings and control towers housed facilities vital to the operation of Army Air Corps installations, where communications were needed between aircraft and ground support. In some cases, these functions were contained in separate buildings. In other cases, control towers were incorporated into hangars or administration buildings.

Association:

Radio buildings are associated directly with the communications theme and illustrate the military's adoption of radio technology. Radio buildings fall into two categories: installation communication services and specialized communications facilities. Installation communication services buildings generally do not possess individual historic significance, but may be contributing buildings to an historic district. If a supporting facility is isolated from the concentration of historic buildings and structures, it may not have *sufficient* visual continuity with the historic district to be a contributing element to the district. However, when visual continuity is not a factor in historic significance, an historic district may contain noncontiguous

¹ David L. Wood, *A History of Tactical Communication Techniques*, Orlando, Martin Marietta Corporation, 1965, 192-200; NARA, Cartographic Branch, RG 77, Standard Plans of Army Post Buildings, 1891 - 1918, Plan 411.

areas. Specialized communications facilities may be eligible for the National Register as individual structures or as historic districts for their historical association with military communications technology, historical events or trends associated with the communications theme, or because they represent an important type, period, or method of construction.

Integrity:

To possess the integrity necessary to convey their significance, radio buildings should retain most of their original design, materials, workmanship, and setting from their period of significance. Structures associated with communications facilities, such as radio transmitter towers, should retain their basic structural design, original configuration, and materials. In cases of subsequent additions or renovations, the building may possess integrity if it retains the majority of its character-defining features, particularly its setting in an overall plan, basic form, materials, and pattern of openings.



Radio Transmitter Building
(Building 830, McChord Air Field, Washington)
Constructed in 1939

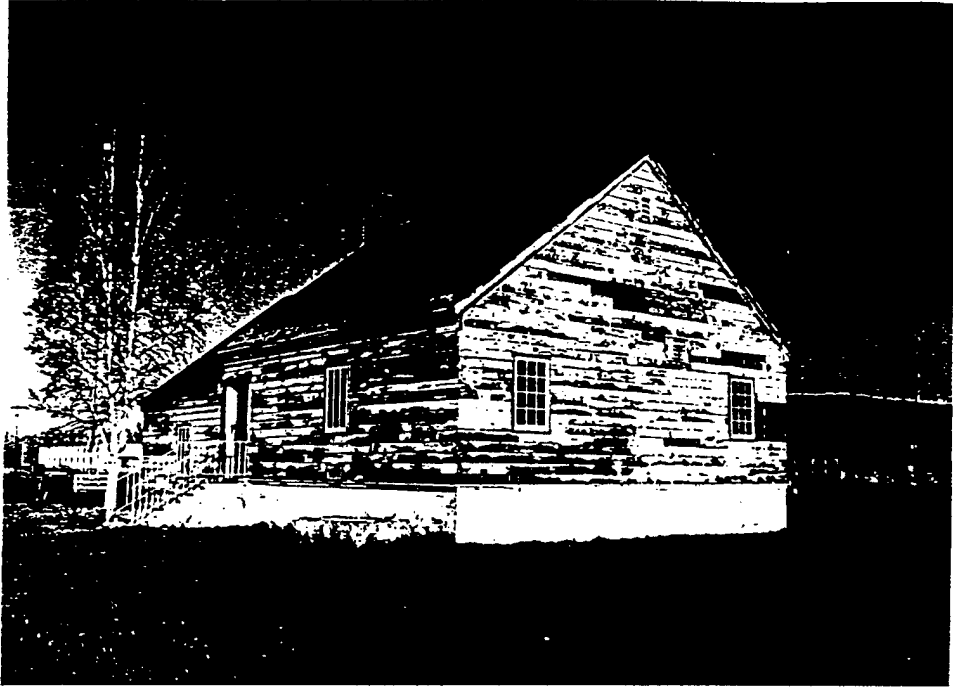

Radio Transmitter Building
Ladd Field, Alaska
Constructed in 1939



Radio Transmitter Building
Ladd Field, Alaska
Constructed in 1939

Category: COMMUNICATIONS

Type 2 b: Telegraph and Telephone Buildings

Description:

Military communications buildings fall into two categories: those that served the basic communications needs on installations and between installations and those that housed the communications facilities of specialized activities or branches. In general, telegraph and telephone buildings fall into the first category of support buildings that facilitate communications on the installation level. Telephone and telegraph buildings generally were located near the main cantonment or administrative area. They usually were constructed as part of major building campaigns and reflected the architectural style of the other installation buildings.

Evolution:

Separate buildings to house installation communication facilities did not appear at Army installations in large numbers until the twentieth century. Until that time, the minimal space occupied by communications facilities, such as telegraph, signal, or telephone offices, could be contained in the administration building. During the 1870s and 1880s, the Army connected posts in the western territories with telegraph lines. Forts in regions such as Arizona or the Dakotas were so isolated that contact with commercial telegraphs was not feasible; however, the post commanders recognized the need for fast, reliable communications, and the Army began to construct its own telegraph lines, usually with cavalry or infantry soldiers performing the labor under the supervision of Signal Corps officers or non-commissioned officers. Since only a single line reached an Army post, a room in a pre-existing building was sufficient for the telegraph office. It was, therefore, unnecessary for the Quartermaster Department to issue a separate standardized building plan for telegraph offices.

The military adopted the newly invented telephone at the end of the nineteenth century. By 1892, 59 of 99 garrisons had some type of telephone equipment.² As in the case of telegraph offices, a room in an existing building was sufficient to house the telephone office.

During the twentieth century, the Army's use of communications technology expanded, and the Quartermaster Department began to plan for the proliferation of communications services. In 1905, the Quartermaster Department designated separate rooms for these functions in their standardized plans for administration buildings. In 1906, the Quartermaster Department issued a standardized plan for a combined post office-telegraph office.³ As the telephone gained popularity during the twentieth century, the Quartermaster Department designed a separate building to house the main switchboard. During the 1930s, Army and Army Air Corps

² Maurice Matloff, *American Military History*, Washington, DC, Government Printing Office, 1969, 295.

³ NARA, Cartographic Branch, RG 77, Standard Plans of Army Post Buildings, 1891 - 1918, Plans 99-D, 177, 177A. Identification of a standardized plan for 1930 telephone exchange buildings was based on field survey at military installations undertaken during 1992.

installations received separate exchange buildings, constructed according to Quartermaster standardized plans.

Association:

Telephone and telegraph buildings are associated directly with the communications theme and illustrate the military's adoption of different communications technologies. Telegraph and telephone buildings illustrate the development of installation communications services. These types of communications buildings generally do not possess individual historic significance, but can be contributing buildings to an historic district if the supporting facility is located near the concentration of historic buildings and structures and retains integrity.

Integrity:

To possess the integrity necessary to convey their significance, telegraph and telephone buildings should retain most of their original design, materials, workmanship, and setting from their period of significance. The architecture of most telegraph and telephone buildings is consistent with the general architectural character of the other installation buildings constructed at the same time. In cases of subsequent additions or renovations, the building may possess integrity if it retains the majority of its character-defining features, particularly its setting in an overall plan, basic form, materials, and pattern of openings.



1907 Post Telegraph Office at (Fort D.A. Russell) F.E. Warren AFB,
Wyoming

Category: EDUCATION

Type 3 a: Classroom Buildings

Description:

Classroom buildings on military installations fall into two general categories: buildings constructed as schools and existing buildings that either served several purposes, including classrooms, or that were adapted as classrooms. In the first case, the buildings built as educational buildings often are imposing architectural monuments in prominent locations on the installation. Apart from major military schools, classrooms often were combined with other uses, such as barracks or administration buildings. The military did not develop standardized plans for classroom buildings, resulting in great variety among the educational facilities as they proliferated after the turn of the century. Buildings built as classrooms generally were long, two-story buildings, with the primary entrance on the long side of the building. They share a similar typology with academic buildings on college campuses and other educational institutions.

Evolution:

Before the Civil War, classroom instruction was not considered an important part of military service. Beyond the U.S. Military Academy at West Point, New York, the Army provided little formal training. Most military training was gained on the job. For the ordinary soldier, the nature of military service required outdoor training or instruction. Recruits first learned to drill on outdoor parade grounds. For general military training, no specialized education buildings were needed. For example, the Artillery School of Practice, established for artillerists at Ft. Monroe, Virginia in 1824, did not require a separate building during its early years; the first mention of a dedicated school building is on the 1889 map of the installation.¹

The oldest military education institution is the U.S. Military Academy, which was established in 1802 to train officers primarily in engineering. Design and construction of buildings at West Point was under the jurisdiction of the Corps of Engineers with funding supplied directly by the U.S. Congress. Its original buildings were typical Federal and Greek Revival public buildings; none of the original classrooms survive. After 1830, most new construction at West Point was Gothic Revival. The Army's selection of Gothic Revival design for the U.S. Military Academy was part of a popular preference during the mid-nineteenth century for Gothic Revival architecture at college campuses.

After the Civil War, military education evolved into a more formal system. The Army instituted the foundations of a military school system in the spirit of a growing sense of military professionalism. Service schools included: the School of Application for artillerists at Ft. Monroe, Virginia (1824; closed in 1860, re-established in 1868); the School of Application for

¹ Maps of Ft. Monroe from 1830, 1843, and 1869 do not indicate a school building. National Archives and Records Administration, Cartographic Branch, Record Group 77, Fortifications File, Ft. Monroe, Virginia.

Infantry and Cavalry at Ft. Leavenworth, Kansas (1881); the Engineer School of Application at Ft. Totten, New York (1885); and, the Cavalry and Light Artillery School at Ft. Riley, Kansas (1892).

These schools required few separate buildings. Older buildings often served combined headquarters, administration, and training functions. At Ft. Leavenworth, the post headquarters served as classroom space for the School of Application. An 1889 map of Ft. Monroe indicates a building outside of the fortifications labeled "school." This building, smaller than the average officers' quarters duplex, may have housed the Artillery School; it no longer stands.² During this period, the Army also began to provide libraries and classrooms as regular components in Quartermaster-designed administration buildings and barracks as the Army instituted post schools for the instruction of junior officers. Classroom buildings were not differentiated clearly from administration buildings during these formative years of the professional military education system.

During the first decade of the twentieth century, the Army expanded its education and training systems. The Army established large, senior officer schools and expanded its officer education system to instruct junior officers in the requirements of their respective branches or departments. The Army's increased emphasis on professional education was reflected in the design and construction of educational buildings. Classroom buildings, both those adapted from earlier uses and those designed as classrooms, became architectural focal points in prominent locations on installations. An example of adaptation of previously existing building stock is located at, Ft. Leavenworth. In 1890, the General Services Schools, the successor to the School of Application, was moved to remodeled ordnance warehouses. In 1904, the buildings were remodeled once more to include the prominent clock tower that is the current symbol of the school.³

Another sign of the increased emphasis on professional education was the selection of prominent civilian architects to design military campuses. After a 1902 national competition, the Army selected the firm of Cram, Goodhue and Ferguson to develop a master plan and design eleven new buildings at the U.S. Military Academy at West Point. Charles McKim, of the preeminent architectural firm of McKim, Mead and White, designed the monumental Army War College (1902-1908), the capstone of the Army's senior education system, at Ft. McNair, in Washington, D.C.

As the Army established more specialized service schools during the beginning of the twentieth century, the Quartermaster Department began constructing separate classroom buildings and libraries, though it did not develop standardized plans for these building types as it did for headquarters buildings, barracks and other installation structures. For example, a complex of

² NARA, Cartographic Branch, RG 92, Blueprint File, Ft. Monroe, Virginia, *A Plan of Fort Monroe, Virginia* 1889.

³ Arthur J. Stanley, "Fort Leavenworth: Dowager Queen of Frontier Posts", *The Kansas Historical Quarterly*, Vol. XIII, No. 1, Spring 1976.

officers' classroom building, enlisted classroom building, and library was constructed at Ft. Monroe in 1909 for the Coastal Artillery School.⁴

In response to the tremendous training needs of World War I, the Army constructed temporary classrooms to train new recruits at mobilization camps. During the 1930s, the Army continued to expand its specialized education system. These new classrooms were designed both by civilian architects and by the Construction Division of the Quartermaster Corps. The firm of McKim, Mead and White designed the Infantry School at Ft. Benning in 1935. The Infantry School is located in a central location in the Ft. Benning master plan and exhibits Colonial Revival architectural influences. Philadelphia architect Harry Sternfeld designed Russel Hall, completed in 1936, for the post headquarters and Signal Corps School at Ft. Monmouth. Russel Hall exhibits the streamlined, stripped classicism popular for public buildings during the 1930s.

The Quartermaster Corps designed classroom buildings as part of their overall installation planning and construction duties. The classroom buildings of this era were larger than their predecessors to accommodate the larger populations and increased amount of training necessary for a modern army. By the 1930s, Quartermaster architects provided designs for educational buildings using both Georgian Colonial Revival and Spanish Colonial Revival Architectural styles. These plans were consistent with the architecture of the new permanent installations constructed by the Quartermaster Corps during that time period. Even with the increase of classroom construction, the Army did not develop standardized plans for educational buildings.

Army Air Corps

With the advent of military aviation, the military developed an entirely new education program to train pilots and ground crews. Early training programs relied on hands-on flight and mechanical training. During World War I, temporary airfields were established across the country to train pilots and ground crews. The only permanent training facilities were a flight school at Rockwell Field, North Island, San Diego, California, and an aerial photography school at Langley Field, Virginia.

Permanent training facilities for the Army Air Corps were constructed after the passage of the Air Corps Act of 1926. Among other provisions, the law authorized additional men and aircraft, and directed the Chief of the Air Corps to develop a five-year plan for implementing the legislation. Although the law did not mention new installations, the expansion of Army aviation implied new facilities. In 1931, the Air Corps Training School and Aviation Medicine School was moved from temporary facilities at Brooks Field to newly-constructed Randolph Field, in San Antonio, Texas. The entire training complex at Randolph Field was designed using the Spanish Colonial Revival architectural style. The educational buildings were part of a complete instructional facility, unified in both purpose and architectural style.

⁴ John Paul Graham, Mary Beth Gatza, and E. Kipling Wright, *The Architectural Heritage of Fort Monroe: Inventory and Documentation of Historic Structures Undertaken by the Historic American Buildings Survey*, vol. 1, Washington, D.C., Historic American Buildings Survey, National Park Service, Department of the Interior, 1987, 29. *Building Location List* (MSS, Directorate of Engineering and Housing, Ft. Monroe, Virginia, N.D..

The Army Air Corps established specialized training facilities at other air fields, including the 1931 Air Corps Tactical School at Maxwell Field, Alabama. Balloon and dirigible training was located at Scott Field, Illinois. In general, classroom buildings constructed for the Army Air Corps training centers continued the Army's tradition of multi-purpose buildings. Classrooms often shared the same building as barracks or administration offices. Because most Army Air Corps installations were constructed during the late 1920s and 1930s, these installations were built according to master plans that integrated the classroom buildings into cohesive architectural designs.

Association:

Classroom buildings may be associated with several important historic contexts: the development of military education and training and the rise of military professionalism; the history and development of individual installations; architectural design; and, installation planning. Buildings associated with the military's educational system may have been built to serve multiple uses, or have been adapted from existing buildings. Thus, when evaluating an installation's role in education and the remaining properties that represent that role, buildings other than those built specifically as classrooms must be examined.

The contexts of architectural design and installation planning are relevant to buildings and installations built specifically as educational facilities. Military properties related to education often were designed by prominent architects or received high levels of design from military architects and engineers. An individual school building may be the work of a master or may embody the distinctive characteristics of its period of construction. Installations designed as schools and constructed as part of a single effort under a master plan can be significant examples of community planning and should be evaluated as entire complexes. Additional research in nonmilitary sources may be necessary to develop fully the appropriate historic context for assessing a property associated with an important architect or important developments in community planning.

Integrity:

To possess the integrity necessary to convey their significance, educational and classroom buildings should retain most of their original design, materials, workmanship, and setting from their periods of construction. Character-defining features of the majority of extant military classroom buildings include the ornamentation and materials defining the particular architectural style of the building, regular pattern of exterior windows and doors, and multi-story height. Educational buildings on military installations often are prominent buildings in key locations in the installation plan.

On installations built as unified "campuses" with an educational mission, classroom buildings share design features in common with the other installation buildings. These features also should remain intact for the building to convey its period of significance. In addition, the relationship among buildings in a campus installation plan should remain relatively intact.

Typical alterations to this building type include replacing or covering original windows and doors. In cases of subsequent additions or modifications, the building may retain integrity if it retains the majority of its character-defining features, particularly its setting in an overall plan, basic form, materials, and pattern of openings.

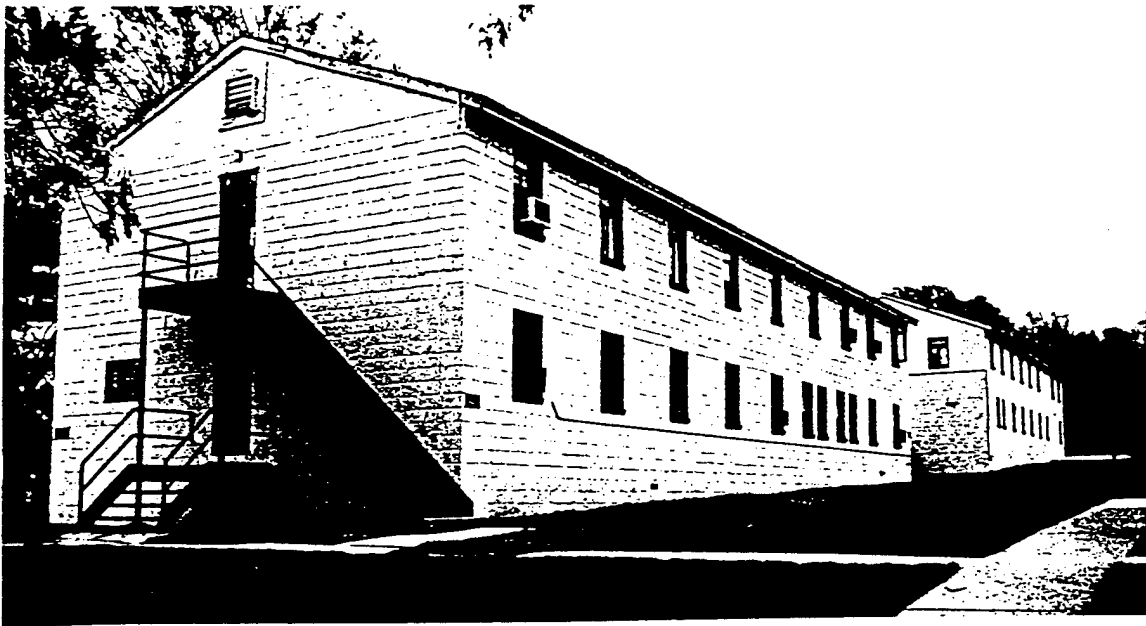

Education Center, Bolling AFB, D.C. Source: Bolling AFB

Category: EDUCATION

Type 3 b: Drill and Riding Halls

Description:

Drill and riding halls were constructed to provide indoor facilities for training activities. These buildings are large rectangular structures enclosing a great expanse of open interior space. Drill halls are not a typical property type found on all installations; they usually are limited to Army cavalry posts, or in at least one instance, Navy training stations. Cavalry riding halls were located near stable complexes, while drill halls were located near barracks.

Evolution:

The cavalry riding hall was introduced on Army posts when the Army consolidated cavalry units on larger installations and expanded facilities for the maintenance, care, and training of horses. The Quartermaster Department issued plans for riding halls during the 1880s. The earliest drill halls were rectangular buildings with large double doors at each gable end. The buildings were lit by windows along the sides and in the gable ends. Often the long gable roof was punctuated by dormers. During the first decade of the twentieth century, the Quartermaster Department revised its drill hall plan to include cross gables, a clerestory, and shaped gable.⁵ At posts with two riding halls, each served a different function. For example, a 1916 map of Ft. Riley indicates that the smaller 1889 riding hall was used as the post riding hall, while the 1908 riding hall was designated as the school riding hall.⁶ Other cavalry posts that did not have riding halls often were located in areas with weather suitable for year-round outdoor training, such as Ft. Bliss, Texas and Ft. Huachuca, Arizona.

The Army continued to construct cavalry drill halls through the 1930s; however, the purpose of the building was changing. The riding halls constructed during the inter-war years reflect local interest in recreational horse-related activities, such as polo, rather than cavalry drill.

No extant examples of infantry drill halls were identified during this study. The infantry generally trained on outdoor parade grounds. An enclosed infantry drill hall was constructed at Plattsburgh Barracks, New York, in 1895, but burned in 1917. After 1900, the Quartermaster Department issued one standardized plan for a combined drill hall and gymnasium; however, the infantry drill hall was not a prevalent building type on Army installations.⁷

Association:

⁵ NARA, Cartographic Branch, RG 77, Standard Plans of Army Post Buildings, 1891-1918, P.I. NM-1 9, Entry 41 1, Plans 97, 97-A.

⁶ NARA, Cartographic Branch, RG 92, Post and Reservation File, Ft. Riley, Kansas, "Post Map of Ft. Riley, Kansas", Revised to September 1916.

⁷ NARA, Cartographic Branch, RG 77, Standard Plans of Army Post Buildings, 1891- 1918, Plans 96, 225.

Drill and riding halls are related to the development of military training and to an installation's mission. Nineteenth- and early twentieth-century riding halls are associated with cavalry training, while mid twentieth-century riding halls are associated with recreational uses. Drill halls are associated with the training of soldiers and sailors, often new recruits.

Drill and riding halls may possess the significance necessary to meet the criteria for listing as a building in the National Register of Historic Places for their association with military education and training and as representatives of a distinctive type. They also should be evaluated as possible contributing elements in a potential historic district related to the installation's educational mission, historical development, or design as a significant and distinguishable entity.

Integrity:

To possess the integrity necessary to convey their significance, drill halls should retain most of their original design, materials, workmanship, and setting from their period of construction. Character-defining features of drill halls include their exterior form, ornamentation evoking a particular architectural style, and pattern of exterior windows and doors. If the building is evaluated as a single building, it also should retain its interior integrity, which is defined by clear, open space. If a drill or riding hall is evaluated as part of an historic district, it should retain the design features that define the architectural character of the installation. Typical alterations to this building type include the replacement of original windows and doors. In cases of subsequent additions or renovations, the building still may possess integrity if it retains the majority of its character-defining features, particularly its setting, exterior form, materials, and pattern of openings.

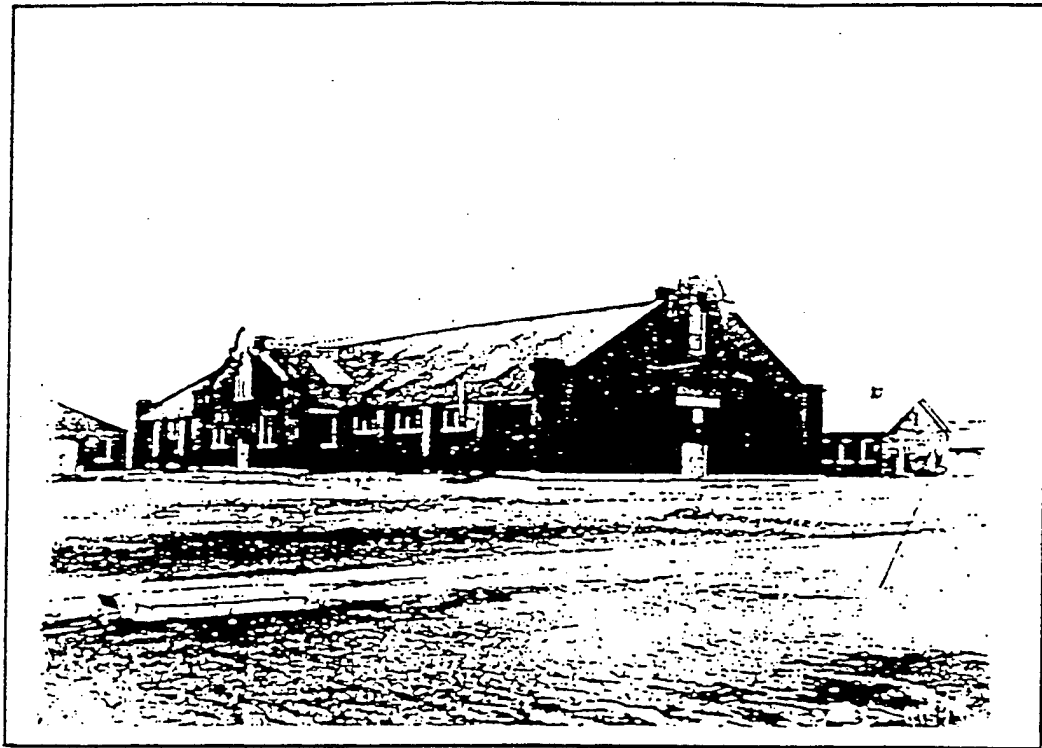

Riding Ring, F.E. Warren AFB. Source: FE.Warren AFB

Category: HEALTH CARE

Type 4 a: Dispensary/Infirmary

Description:

The dispensary or infirmary was a small medical facility constructed near the central area of an installation to provide primary short-term care for military personnel. Dispensaries and infirmaries supplemented the post hospital. The dispensaries and infirmaries were generally small, rectangular, one- or two-story buildings constructed of permanent materials.

Evolution:

At Army installations, small post hospitals originally provided both long-term and short-term medical care. Hospital plans included a room designated as the dispensary. Hospitals often were located a short distance away from the parade ground to prevent the spread of contagious diseases and to isolate the unpleasant odors accompanying nineteenth-century medicine at isolated posts. As the Army began to consolidate its troops in larger installations during the 1880s and 1890s, hospital complexes increased in size and were located even farther away from the main cantonments. The dispensary apparently evolved as a separate building type located closer the barracks to provide immediate and primary medical care to the larger garrisons of troops at the consolidated installations. The level of care available at dispensaries was similar to the basic care provided in the earlier frontier hospitals.

The earliest dispensary identified in this study was located in Ft. Riley, Kansas (Building 28), constructed in 1889. The Quartermaster Department issued its first standardized plans for dispensaries in 1908 and again in 1910 and 1911.¹ The Office of the Quartermaster constructed dispensary buildings only at larger installations. Examples of inter-war era dispensaries were identified at Ft. Leavenworth, Kansas (1927) and at Ft. Benning, Georgia (1931).

Association:

Dispensaries and infirmaries are associated with the growth of medical services as military installations grew larger and the military provided more services to its personnel and their dependents. Dispensaries and infirmaries are minor building types constructed to provide primary medical care and to supplement larger military hospitals. These buildings are not likely to possess individual significance, but may be contributing buildings to an historic district if they retain sufficient integrity from the period of significance of the historic district.

Integrity:

¹ National Archives and Records Administration, Cartographic Branch, Record Group 77, Standard Plans of Army Post Buildings, 1891-1918, (P.I. NM - 19 Entry 41 1), Plans 247, 279.

No character-defining features specific to infirmaries and dispensaries were identified during this study. Therefore, the standards for assessing the integrity of examples of this building type are the same standards as for evaluating the integrity of any building. To possess architectural integrity, dispensaries and infirmaries should retain most of their original materials, design, and setting. Few pre-1940 dispensaries and infirmaries remain in use as medical facilities; most have been adapted for other uses. In cases of additions or renovations, the building still may possess integrity if it retains the majority of the features that constituted its basic design, including materials, building form, roof shape, porches, pattern of windows and doors, and ornament.



1933 Base Dispensary at Bolling AFB, Washington DC

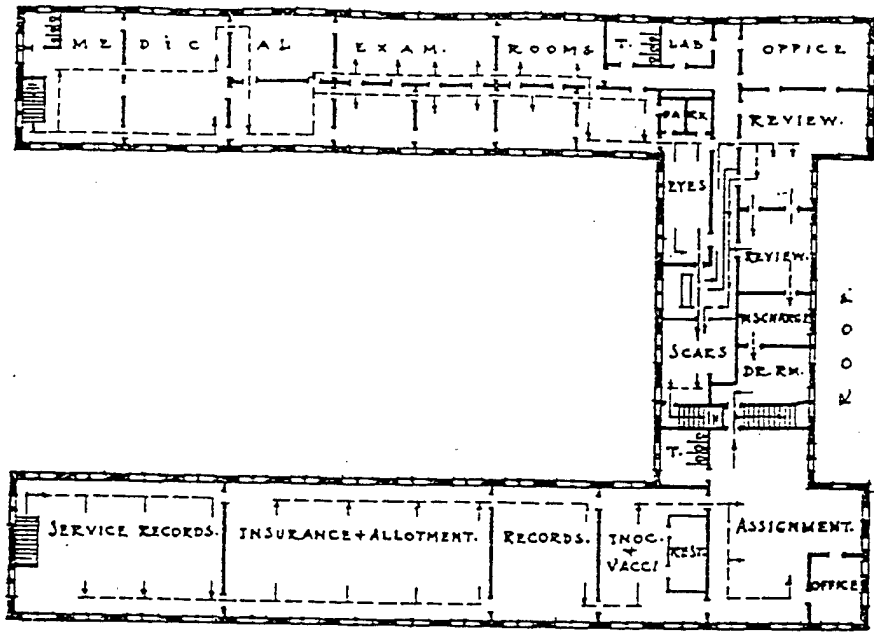

SECOND FLOOR PLAN.

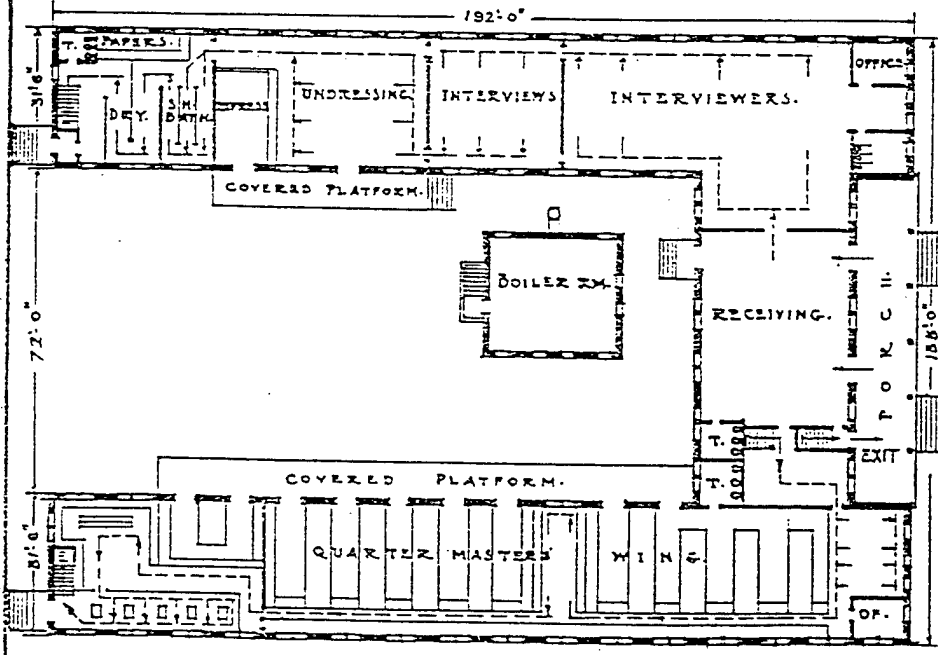
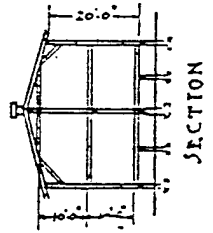
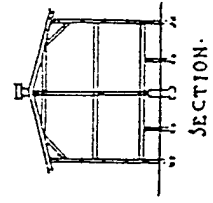

FIRST FLOOR PLAN.

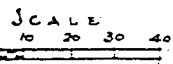
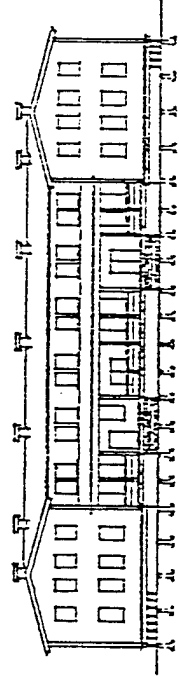

SB-19

FOR DETAILS SEE DRAWINGS - NO. 620-488-489.

CONSTRUCTION DIVISION OF THE ARMY.
 TYPICAL BUILDINGS.
 .RECRUIT EXAMINATION BUILDING.

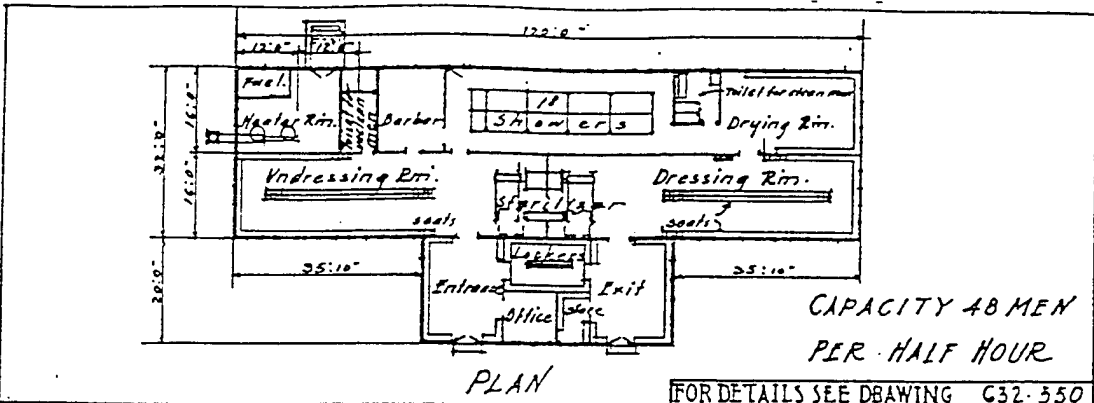

PLAN

FOR DETAILS SEE DRAWING G32-550

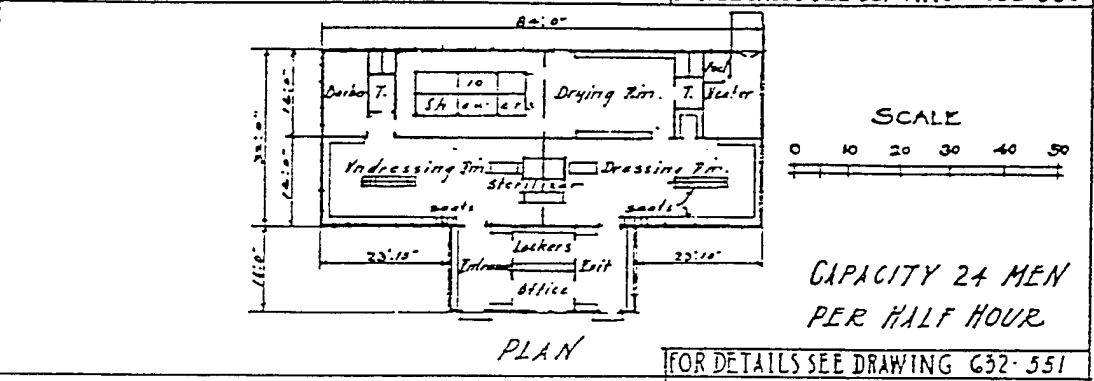

PLAN

FOR DETAILS SEE DRAWING G32-551

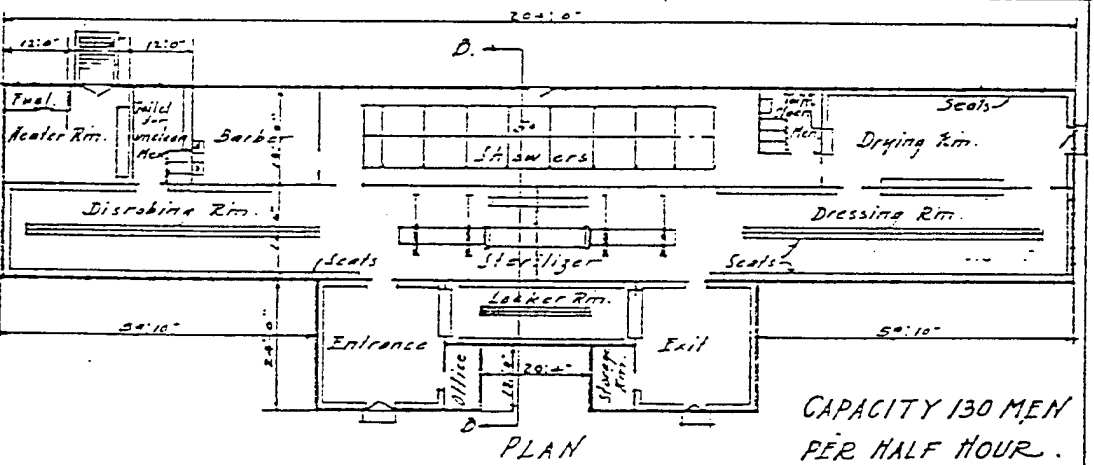
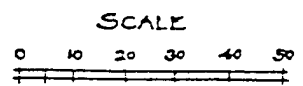

PLAN

FOR DETAILS SEE DRAWING G32-550

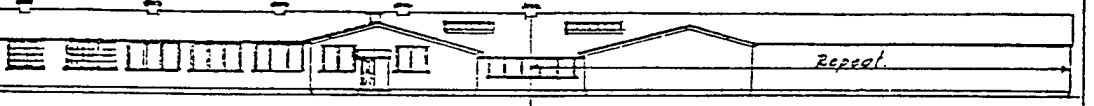

FRONT ELEVATION

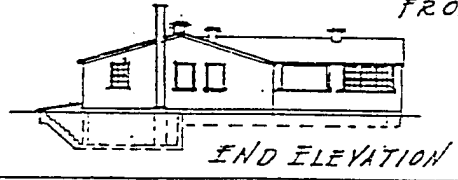

END ELEVATION

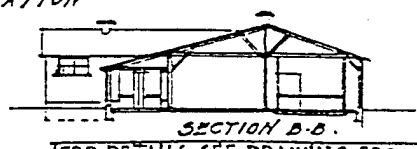

SECTION B-B.

FOR DETAILS SEE DRAWING G32-550.

CONSTRUCTION DIVISION OF THE ARMY
 TYPES OF DELOUSING PLANTS
 VARYING CAPACITIES

SB-21

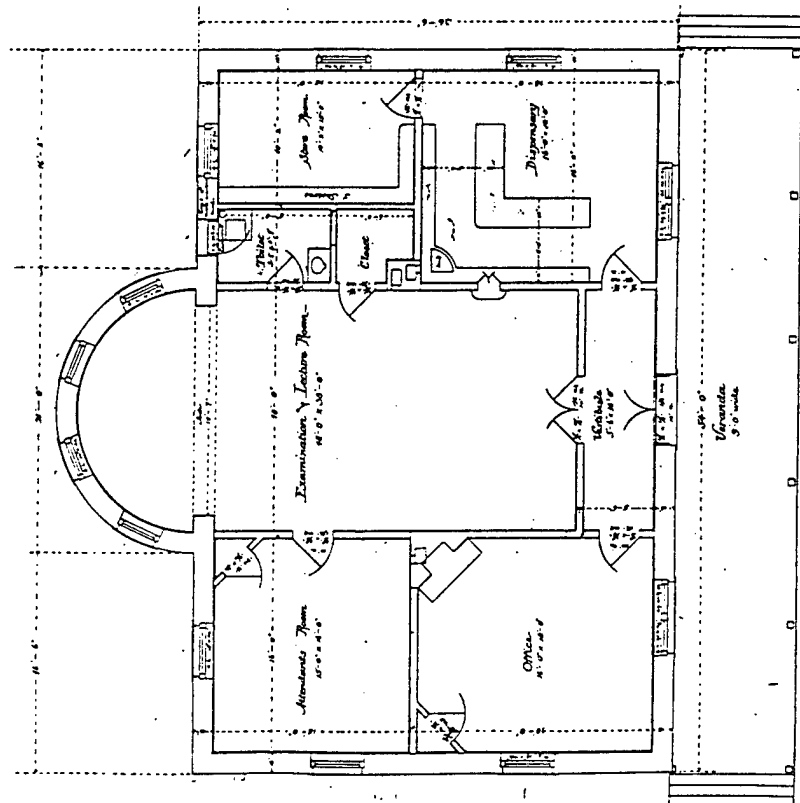

Ground Plan

Three Columns

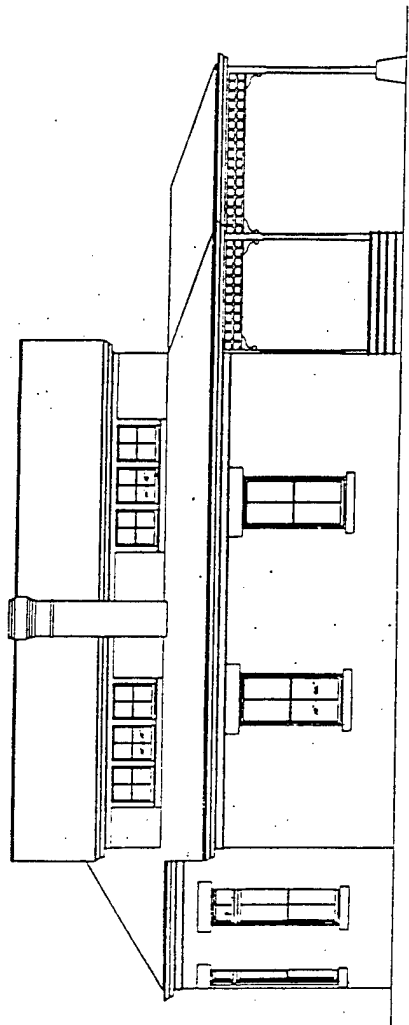

Side Elevation

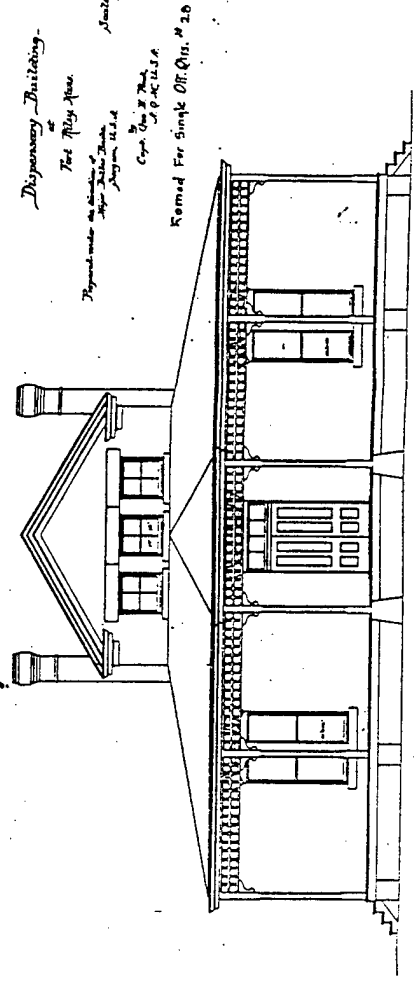

Front Elevation

Dispensary Building
 Fort Riley, Mo.
 Prepared under the direction of
 Major John B. Smith
 Surgeon, U.S.A.
 By Wm. B. Wood
 Civil Engineer
 U.S.A.

Revised For Single Off. Qtr. # 20

NO 028-02.CIT

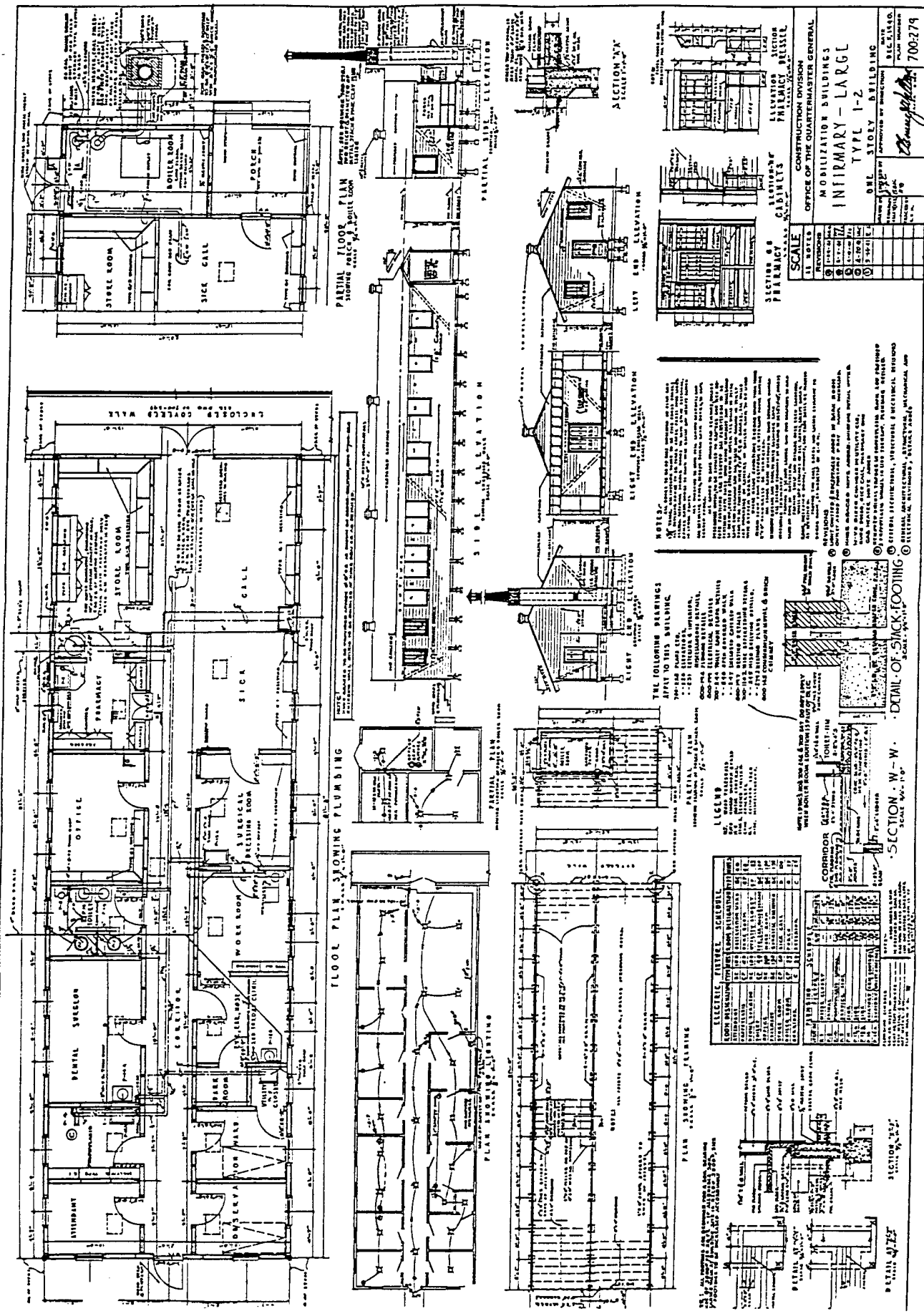

FLOOR PLAN SHOWING PLUMBING

FLOOR PLAN SHOWING PLUMBING

PLAN SHOWING PLUMBING

PLAN SHOWING PLUMBING

SIDE ELEVATION

SIDE ELEVATION

SIDE ELEVATION

SIDE ELEVATION

SIDE ELEVATION

SIDE ELEVATION

SECTION W-W

SECTION W-W

SECTION W-W

SECTION W-W

SECTION W-W

SECTION W-W

NOTES:
 1. THE FOLLOWING BEARINGS APPLY TO THIS BUILDING.
 2. ALL DIMENSIONS ARE TO CENTER UNLESS SPECIFICALLY NOTED OTHERWISE.
 3. ALL WALLS TO BE CONSTRUCTED IN ACCORDANCE WITH THE CITY ENGINEER'S SPECIFICATIONS.
 4. ALL ROOFS TO BE AS SHOWN UNLESS OTHERWISE SPECIFIED.
 5. ALL FLOORS TO BE AS SHOWN UNLESS OTHERWISE SPECIFIED.
 6. ALL CEILING TO BE AS SHOWN UNLESS OTHERWISE SPECIFIED.
 7. ALL ELECTRICAL WORK TO BE AS SHOWN UNLESS OTHERWISE SPECIFIED.
 8. ALL PLUMBING WORK TO BE AS SHOWN UNLESS OTHERWISE SPECIFIED.

LEGEND:
 - ALL WALLS TO BE CONSTRUCTED IN ACCORDANCE WITH THE CITY ENGINEER'S SPECIFICATIONS.
 - ALL ROOFS TO BE AS SHOWN UNLESS OTHERWISE SPECIFIED.
 - ALL FLOORS TO BE AS SHOWN UNLESS OTHERWISE SPECIFIED.
 - ALL CEILING TO BE AS SHOWN UNLESS OTHERWISE SPECIFIED.
 - ALL ELECTRICAL WORK TO BE AS SHOWN UNLESS OTHERWISE SPECIFIED.
 - ALL PLUMBING WORK TO BE AS SHOWN UNLESS OTHERWISE SPECIFIED.

DETAIL OF WALL-FOOTING

SCALE: 1/2" = 1'-0"

DETAIL OF SINK

SCALE: 1/2" = 1'-0"

DETAIL OF SINK

SCALE: 1/2" = 1'-0"

DETAIL OF SINK

SCALE: 1/2" = 1'-0"

DETAIL OF SINK

SCALE: 1/2" = 1'-0"

DETAIL OF SINK

SCALE: 1/2" = 1'-0"

NO.	DESCRIPTION	QTY.	UNIT	PRICE	TOTAL
1	CEMENT	50	CU. YD.	1.50	75.00
2	BRICK	1000	SQ. YD.	0.05	50.00
3	ROOFING	1000	SQ. YD.	0.10	100.00
4	PLASTER	500	SQ. YD.	0.20	100.00
5	PAINT	100	SQ. YD.	0.50	50.00
6	LUMBER	1000	SQ. YD.	0.05	50.00
7	ELECTRICAL	1000	SQ. YD.	0.10	100.00
8	PLUMBING	1000	SQ. YD.	0.10	100.00
9	CONCRETE	1000	SQ. YD.	0.10	100.00
10	IRON	1000	SQ. YD.	0.10	100.00
11	STEEL	1000	SQ. YD.	0.10	100.00
12	COPPER	1000	SQ. YD.	0.10	100.00
13	ZINC	1000	SQ. YD.	0.10	100.00
14	GLASS	1000	SQ. YD.	0.10	100.00
15	PAINT	1000	SQ. YD.	0.10	100.00

CEMENT	50	CU. YD.	1.50	75.00
BRICK	1000	SQ. YD.	0.05	50.00
ROOFING	1000	SQ. YD.	0.10	100.00
PLASTER	500	SQ. YD.	0.20	100.00
PAINT	100	SQ. YD.	0.50	50.00
LUMBER	1000	SQ. YD.	0.05	50.00
ELECTRICAL	1000	SQ. YD.	0.10	100.00
PLUMBING	1000	SQ. YD.	0.10	100.00
CONCRETE	1000	SQ. YD.	0.10	100.00
IRON	1000	SQ. YD.	0.10	100.00
STEEL	1000	SQ. YD.	0.10	100.00
COPPER	1000	SQ. YD.	0.10	100.00
ZINC	1000	SQ. YD.	0.10	100.00
GLASS	1000	SQ. YD.	0.10	100.00
PAINT	1000	SQ. YD.	0.10	100.00

SECTION W-W
SCALE: 1/2" = 1'-0"

SECTION W-W

SECTION W-W

SECTION W-W

SECTION W-W

SECTION W-W

SECTION W-W

SECTION W-W

SECTION W-W

SECTION W-W

SECTION W-W

SECTION W-W

SECTION W-W

SECTION W-W

SECTION W-W

SECTION W-W

SECTION W-W

SECTION W-W

SECTION W-W

SECTION W-W

SECTION W-W

SECTION W-W

SECTION W-W

SECTION W-W

SECTION W-W

SECTION W-W

SECTION W-W

SECTION W-W

SECTION W-W

SECTION W-W

SECTION W-W

SECTION W-W

SECTION W-W

SECTION W-W

SECTION W-W

SECTION W-W

Category: HEALTH CARE

Type 4 b: Hospitals

Description:

Military hospitals are buildings or building complexes constructed for the medical care of military personnel, civilian employees, and dependents. The size of the hospital facility is related directly to the size of the installation or to the geographical area it served. Installation hospitals generally were set apart from the other buildings within the installation plan. Hospitals that served larger regions were located on separate installations devoted exclusively to a medical mission. The architecture of hospitals reflected contemporary medical philosophies of medical care and often included high-style architectural ornamentation typical of the period of construction. Nineteenth-century military hospitals generally had a central block with ward wings and verandas around the building. Early twentieth-century military hospitals followed the same design, but with Colonial Revival or Classical stylistic references. By the 1930s, hospital plans no longer included open verandas. By 1940, the multi-story tower design was adopted as the preferred design for Army general hospitals.

Evolution:

Army hospitals fall into two categories: post hospitals and general hospitals. Post hospitals served the personnel at specific installations, while general hospitals served a larger population of troops, regardless of unit. Post hospitals were constructed at most Army forts throughout the nineteenth and twentieth centuries. As the Army grew in size and as medical science improved, the Army constructed general hospitals to better care for the increased number of soldiers, particularly during and immediately after wartime.

Post hospitals evolved from the early system of Army medical care. In 1818, the Army established the office of Surgeon General to oversee the medical treatment of soldiers. Though doctors were assigned to regiments or posts, the condition of medical facilities remained poor. Before the Civil War, post hospitals often were housed in a single room of an existing post buildings or in the damp, stone casements of coastal fortifications. Separate hospital buildings, when built, resembled the quarters or barracks buildings.

By the eve of the Civil War, the Army Quartermaster Department began developing standardized building plans for many building types, including hospitals. Army construction regulations published in 1861, though never officially adopted, influenced Army construction. The unofficial regulations depicted a recommended hospital plan that resembled an registered men's barrack with a rear ward wing. This hospital plan could be expanded by the construction of additional ward wings. The Army hospital contained most functions, including dispensary, kitchen, mess room, and hospital steward quarters, within a single building. Support buildings for the hospital complex often included smaller buildings such as a sink (latrine) and a dead

house (morgue). The unofficial regulations included a typical post plan, with the hospital located apart from the cantonment.²

During the Civil War, the medical treatment and care of Army personnel improved. After the war, the Army continued to try to improve the general medical care received by troops. In 1867, the Surgeon General issued a circular describing the ideal post hospital: a central two-story block, containing administration offices, flanked by two, one-story ward wings that accommodated 24 beds, with a rear kitchen wing and surrounding veranda. Garrison size determined the size of the post hospital. Most troops were scattered in small installations ranging in size between two and ten companies of men. For smaller Army installations, the plan could be modified to include only one ward wing. The plan also could be expanded to accommodate 48 beds by extending the ward wings.³

In 1870, the Surgeon General published a report on barracks and hospitals in which he praised the 1867 plan as the embodiment of the true principle of hospital construction and a great step forward. Yet, he rated the actual state of Army barracks and hospitals as deplorable. In many cases, older hospitals were still in use. Where new hospitals had been constructed, the Quartermaster Department had ignored the 1867 hospital plan. To control hospital construction, the Secretary of War issued regulations in 1870 that directed the Quartermaster Department to construct post hospitals using specified appropriations, not general construction funds.⁴

Regulations for Army post hospital design were issued regularly throughout the late nineteenth and early twentieth centuries (1871, 1877, 1888, and 1906). In general, these plans remained remarkably similar to the 1867 plans. For example, in 1871, the Surgeon General issued plans for permanent and temporary hospitals. The standard post hospital design consisted of a two-story central block flanked by two one-story wings and accommodated 24 beds. The regulations also included two plans for a two-story, 12-bed hospital and a plan for a provisional hospital for temporary posts. A character-defining feature of these hospitals is the wide surrounding veranda. The Army hospitals of this era also incorporated Victorian design elements, such as bay windows and wood spindlework. Examples of these hospital plans can be found at many Army posts active during the late nineteenth century.⁵

In one instance, the Army built a large hospital to care for veterans. In 1875, the Barnes Hospital at the Soldiers' Home near Washington, D.C. contained 50 beds and had a three-story central block flanked by two-story ward wings. The building was an elaborate, French Second Empire style building with a tall mansard roof, bracketed cornices, and hooded, arched windows.

² War Department, *Regulations Concerning Barracks and Quarters for the Army of the United States, 1860*, Washington, D.C.: George W. Bowman, 1861, 3-4.

³ U.S. Surgeon General's Office, *Plan for a Post Hospital of 24 Beds* (Circular No. 4), Washington, D.C.: Government Printing Office, 1867, passim.

⁴ War Department, Surgeon General's Office, *A Report on Barracks and Hospitals with Descriptions of Military Posts* (Circular No. 4), Washington, D.C.: Government Printing Office, 1870, 21; Erna Risch, *Quartermaster Support for the Army. A History of the Corps 1775-1939*. Washington, D.C.: Government Printing Office, 1962, 486.

⁵ U.S. Surgeon General's Office, *Approved Plans and Specifications for Post Hospitals* (Circular No. 2), Washington, D.C.: Government Printing Office, 1871, passim.

Though the Barnes Hospital was much larger than the post hospitals of the time, it followed the basic plan of post hospitals.

During the 1880s and 1890s, the Army began to consolidate troops into larger, permanent posts. The size of post hospitals increased to serve the larger garrisons. During the same era, concerns about poor living conditions for Army personnel led to improvements in Medical Corps housing. Before 1888, medical personnel lived in rooms located in the hospital. In 1888, the Army authorized separate housing for the hospital steward, and the Quartermaster Department subsequently issued standardized plans. After this time, the Army provided separate housing and barracks for medical personnel. Many nineteenth- and early twentieth-century post hospitals have detached hospital stewards quarters next to the hospital.

Post hospitals during the early twentieth century retained the basic arrangement of the late nineteenth-century hospital plan, the two-story central administration block, flanked by two ward wings with porches along the wings, but were enlarged. The increase in size was accommodated through raising the height of the ward wings from one to two stories and constructing additional rear wings. The architectural character of the hospitals reflected Colonial Revival or Classical Revival design. One significant change in hospital interior layout was that doctors could concentrate more patients in a single ward as they learned more about the causes of the spread of diseases and the importance of disinfectants. As the size of post hospitals increased, the number of medical personnel increased, and more buildings were needed to maintain the hospital complex. Post hospitals often grew into multi-building complexes, with a main hospital accompanied by an isolation hospital, kitchen, morgue, laundry, power plants, and hospital stewards quarters.

By 1917, the Army had 131 post hospitals and five base hospitals. Base hospitals were expanded versions of post hospitals that provided more surgical and medical services and often comprised building complexes. Base hospitals, such as those at Ft. Sam Houston and Ft. Bliss, contained 200 beds each; with the addition of pavilion wards, these hospitals could be increased to a capacity of 700 and 900 beds respectively.⁶

During the nationwide Army construction program initiated in 1926, the Army built many new, permanent posts and airfields. Hospitals were constructed at all new installations. The standard design still retained the characteristic central block with flanking wings, though the height was increased to three stories. The long, open verandas characteristic of nineteenth- and early twentieth-century hospitals disappeared from the basic plan and sometimes were replaced with smaller sun porches. Medical Corps and Nurses Corps barracks often were constructed next to the hospital.

The second type of Army hospital was the general hospital. General hospitals were established to treat general and specialized medical problems and all injuries. The staff at post hospitals sent personnel suffering from obscure or serious illnesses to general hospitals. The system of general

⁶ Merritte W. Ireland, *The Medical Department of the United States Army in the World War*, Vol. V, Washington, D.C.: Government Printing Office, 1923, 25.

hospitals evolved slowly from a series of temporary wartime hospitals to a system of permanent general hospitals.

During the Second Seminole War, the Medical Department established general hospitals near the most important supply depots. General hospitals also followed the armies during the Mexican War. These general hospitals occasionally were housed in a building, but more were placed in tents.⁷

The overwhelming medical needs of the Civil War resulted in the construction of buildings that were designed specifically as Army general hospitals to care for all soldiers regardless of unit. The Army utilized a "pavilion" type of hospital, which consisted of wards that were physically separated from one another and connected by corridors or covered walkways. Because doctors mistakenly believed that diseases were transmitted through "vapors," they believed the pavilion design would prevent the spread of disease. Though their understanding of epidemiology was wrong, the physical separation of patients in these hospitals produced a low death rate for the time. By the close of the war, the Army had 204 general hospitals, with a total of 136,894 beds. The first pavilion-type hospital was built at Parkersburg, West Virginia, followed by hospitals at Louisville, Memphis, Chattanooga, and Jeffersonville, Indiana.⁸

In 1887, the military created the first peacetime general hospital at Hot Springs, Arkansas. However, most soldiers still were treated at post hospitals until the Spanish-American War and the Philippine Insurrection. The Army established general hospitals to treat the troops returning from those conflicts. During the Spanish-American War, the Army had built a temporary general hospital at Washington Barracks. In 1908, the Army relocated the temporary facility to the northern part of the District of Columbia to form a permanent peacetime general hospital, which later was renamed the Walter Reed Army Medical Center. Sick and wounded soldiers returning from the Philippines were treated at Letterman General Hospital at the Presidio of San Francisco. At Ft. Bayard, New Mexico, the Surgeon General established a specialized general hospital to care for the increased number of tuberculosis cases. General hospitals continued to follow the pavilion plan of a main hospital surrounded by a series of detached individual wards. By 1917, the Army had four general hospitals.

The demands of World War I again caused the Army to expand its general hospital system. Post hospitals were expanded to serve as regional general hospitals. For example, Ft. Benjamin Harrison, Indiana, was designated General Hospital No. 25 in 1918. The wartime general hospital at Ft. Benjamin Harrison was housed in existing buildings and in temporary, wood-frame mobilization buildings, and was returned to post hospital status in 1919. The Army also established new general hospitals. By 1918, the number of tuberculosis patients overwhelmed the hospital at Ft. Bayard, which was transferred to a site near Denver, Colorado, and named General Hospital No. 21. It later became Fitzsimons General Hospital. The early plan of Fitzsimons clearly illustrates the dispersed wards typical of the pavilion-plan general hospitals.

⁷ Mary C. Gillett, *Army Medical Department 1818-1865*. Washington, D.C.: Government Printing Office, 1981, 63-65, 101-102.

⁸ George W. Adams, *Doctors in Blue: The Medical History of the Union Army in the Civil War*. New York: Henry Schuman, 1952, 149-173; Percy Ashburn, *A History of the Medical Department of the United States Army*, Boston: Houghton Mifflin Company, 1929, 88.

By 1929, the general hospital system had expanded to eight Army general hospitals with the addition of Fort Sam Houston, Texas; Beaumont, El Paso, Texas; Sternberg Hospital, Manila, Philippines; and, Tripler Hospital, Honolulu, Hawaii.

During the 1930s, the design of hospitals changed dramatically. Consolidated buildings with massive multi-storied towers replaced the dispersed pavilion plan. This significant change reflected the better understanding of epidemiology. The pavilion plan had developed in answer to concerns that stale air or "vapors" caused disease; now that doctors understood the bacterial causes of disease transmission and the importance of antiseptics, the dispersed pavilion plan was obsolete. The consolidated, tower hospital plan minimized the distances between wards, resulting in savings of staff time and infrastructure, i.e. lighting and heating ducts. The new hospital plan type was developed in the United States; the first example was the Columbia Presbyterian Medical Center, New York, started in 1928.⁹ The military quickly adopted this civilian precedent. In 1936, the Surgeon General ordered military planners to develop plans for a new hospital building, with all wards concentrated in a single building, at Fitzsimons. In 1938, congress approved funds for construction of the new 610-bed hospital, which at the time was the largest single hospital structure ever built by the Army; the building was finished in 1941. The building displays the stripped, Art Moderne style popular for large public buildings of the 1930s. The construction of a new general hospital at Ft. Sam Houston, Texas, also was started during the late 1930s and also followed the consolidated, multi-story plan with Art Moderne exterior design.

Association:

Hospitals are associated intimately with the historical context of military medicine. They represent the medical treatment philosophies of the nineteenth and twentieth centuries, the military's concern for adequate health care for its personnel, and, in some cases, medical research. Hospitals also may be associated with important architects or be good examples of a type of construction or possess high artistic values.

Hospital buildings are major building types. A hospital may possess individual significance because of historical associations or architectural merit, and may be a major contributing building to an historic district. Army post hospitals often were a major element of the installation plan.

Integrity:

To possess integrity, hospitals should retain most of their design, setting, materials, from their period of significance. However, hospital buildings often are among the most modified of military building types. Hospitals were subject to modifications, additions, and renovations to keep them up to date with medical technology and the growing number of patients. The additions themselves may have attained significance if they illustrate the evolution of medical care and hospital design, or represent a type or method of construction.

⁹ Nikolaus Pevsner, *A History of Building Types*. Princeton: Princeton University Press, 1976, 158.

Many military hospitals constructed before 1940 no longer function as hospitals. Army post hospitals often have been adapted for use as headquarters buildings, e.g. Forts Myer, Riley, Leavenworth, and Benjamin Harrison. In some cases, character-defining features, including entries, window openings, and porches have been modified. Even in cases of modern additions and renovations, the building still may possess integrity if it retains the majority of its character-defining features. To determine what the character-defining features are, the type of hospital plan represented and the building's original appearance must be identified. Important elements to evaluate when assessing integrity are building plan and exterior shape, materials, roof shape, verandas, pattern of openings, architectural features such as columns, brackets, trim that represent the period of construction, and setting.

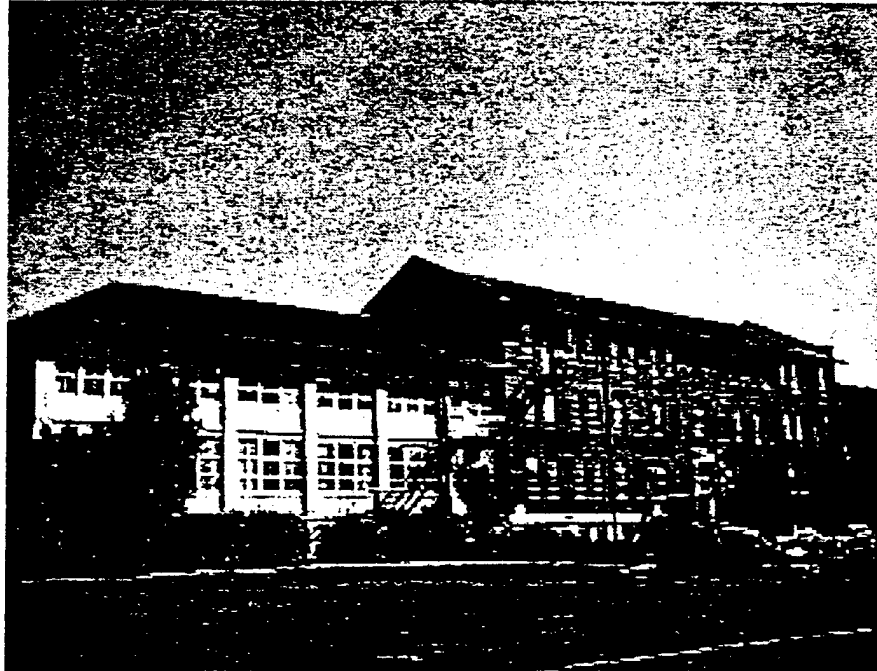

1929 Post Hospital at Fort Lewis, WA



1903-04 Post Hospital at Vancouver Barracks, WA

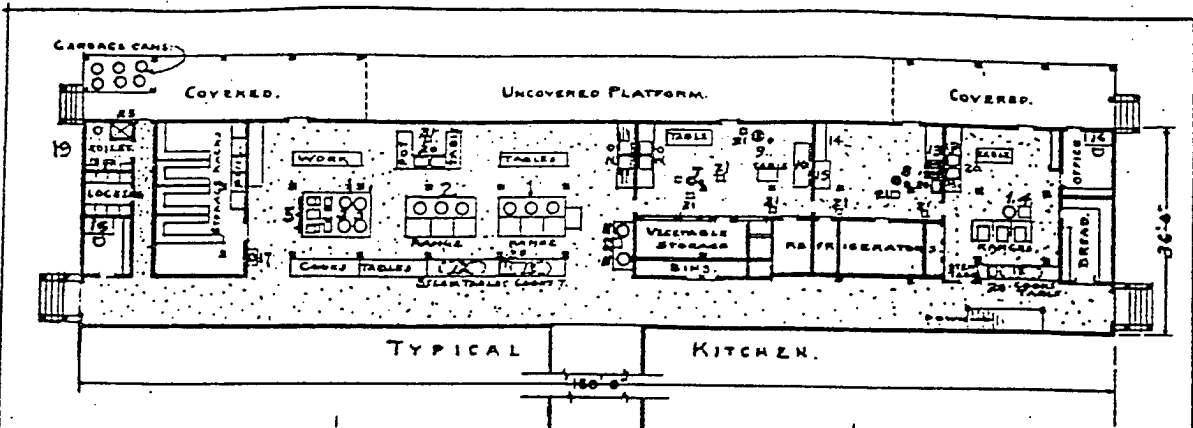

- NOTES.
- 1 STOCK KETTLES.
 - 2 ROASTING KETTLES.
 - 3 MEAT ROASTERS.
 - 4 VEGETABLE BOILER.
 - 5 VEGETABLE COOKER.
 - 6 DISH WASHING MACHINE.
 - 7 VEGETABLE PEELER.
 - 8 MEAT CHOPPER.
 - 9 ICE CREAM FREEZER.
 - 10 ICE CREAM BOX.
 - 11 URN.
 - 12 SAUCEPAN RACK.

- NOTES.
- 13 BUTCHER BENCH & BLOCK.
 - 14 FISH TABLE.
 - 15 FISH BOX.
 - 16 DESK.
 - 17 LAVATORY.
 - 18 URINAL.
 - 19 TOILET.
 - 20 SINKS.
 - 21 FLOOR DRAIN
 - 22 SUNK FLOOR DRAIN.
 - 23 SHOWER.

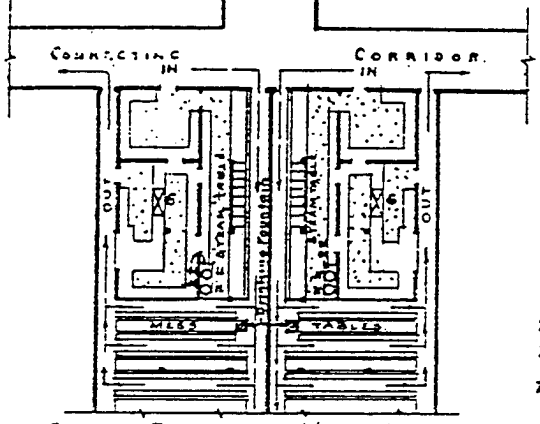

SERVING ROOMS AND MESS ROOMS.
 TYPICAL LAYOUT.
 FOR
 HOSPITAL MESS AND KITCHEN, 3000 TO 5000 CAPACITY.
 SCALE

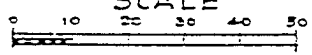

FOR DETAIL PLAN, SEE DRAWING 6402-938

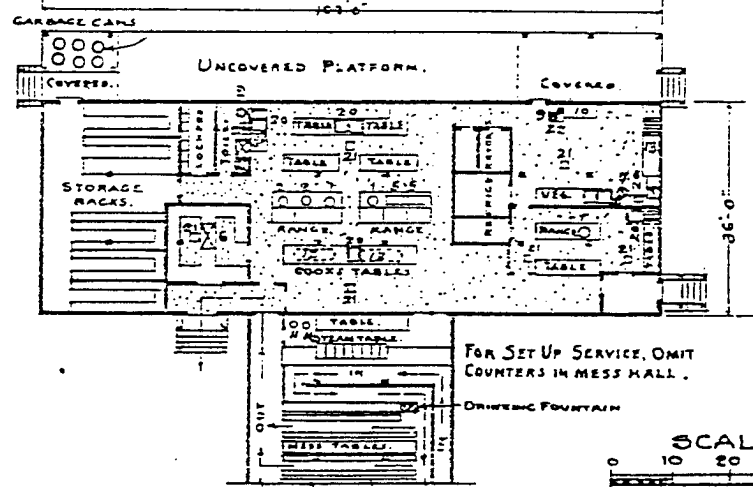

KITCHEN, SERVICE ROOM AND MESS ROOM
 TYPICAL LAYOUT
 FOR
 HOSPITAL MESS AND KITCHEN, 1000 TO 1500 CAPACITY.

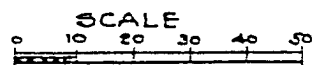

FOR DETAIL PLAN SEE DRAWING 6402-931.

CONSTRUCTION DIVISION OF THE ARMY
 HOSPITAL BUILDINGS
 TYPICAL KITCHEN LAYOUT. SB-14

Maximum Allowable Variation
from North of Transverse Axis of
Surgical Wing.

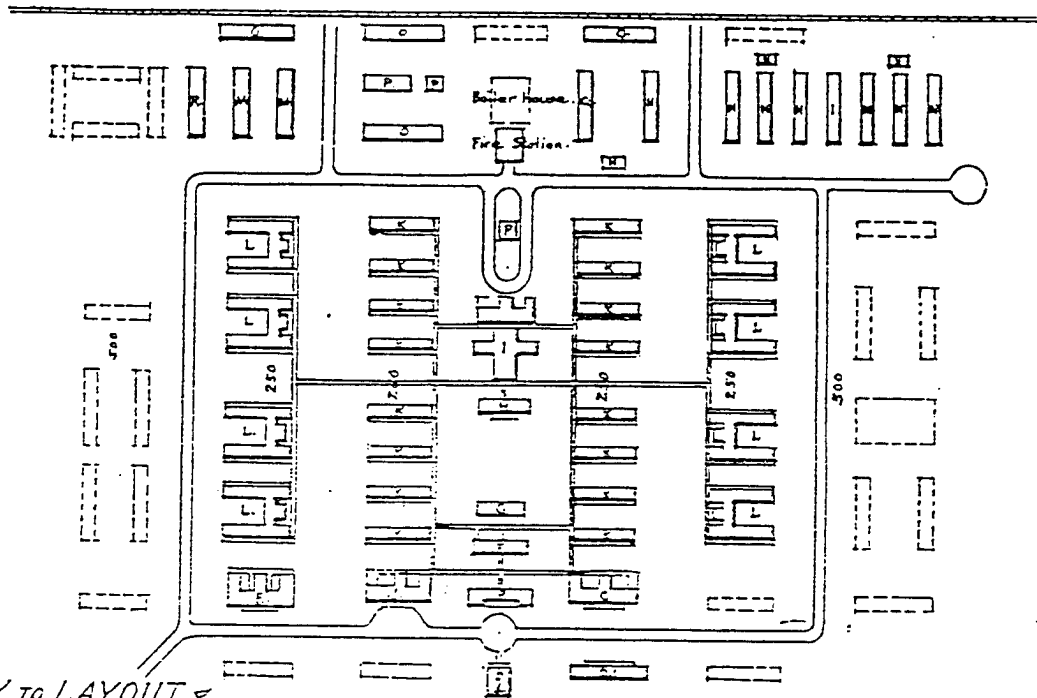
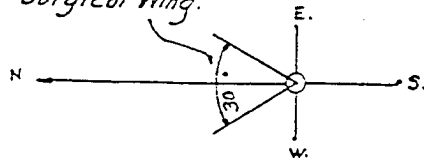

KEY TO LAYOUT

- B Administration
- C Officers Ward.
- D&D1 " Quarters.
- E Nurses "
- F Laboratory
- G Operating Pavilion
- H Post Exchange.
- H Garage - Shop.
- I Mess Kitchen
- J Receiving Ward
- K Single Ward
- L Ward & Lavatory
- M Isolation Ward
- N 2 Story Hosp. Corps Barracks.
- O Store House
- P Chapel
- P Mortuary
- P Guard House
- Q Laundry
- R. Neuro Psychiatric Ward
- Fire Station
- Baller House
- Red Cross.

CAPACITY 1000 BEDS.

DOTTED LINES SHOW FUTURE BUILDINGS

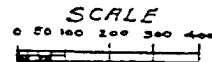

For Details see Drawing 63Z-78.

CONSTRUCTION DIVISION OF THE ARMY
SCHEMATIC LAYOUT-PAVILION TYPE
CONSTRUCTED FOR THE
SURGEON GENERAL OF THE ARMY

·A·
SGO-A

KEY TO LAYOUT

- B-9. Adminis. & Rec. Buildings.
- C-10 1st Floor Ward
- D-10 2nd " Officers Quarters
- D-11 Officers Quarters
- D-11 Off. Quarters, Mess & Kitchen & Attendants' Dormitory
- E-10 Nurses Quarters
- E-21 " " with Infirmary
- E-22 " " Mess & Kitchen
- F-7 Laboratory & Mortuary
- H-12 Operating Wing
- H-13 Garage
- H-14 Shop
- H-14 Hospital Exchange
- H-14 General Mess, Cafe & Kitchen
- K-34 Wards
- N-3 1st Fl. Prison Ward, 2nd Fl. Bot. Isolation
- N-4 " " Solar " " Patients
- N-9 Hosp. Corps Barracks
- N-10 2nd " " Barracks
- O-10 Store House
- P-6 Commissary Stores
- P-6 Chapel
- P-7 Psychiatric Ward
- Power House
- Fire Station

CONSTRUCTION DIVISION OF THE ARMY
 SCHEMATIC LAYOUT-HEAD HOUSE TYPE
 CONSTRUCTED FOR THE
 SURGEON GENERAL OF THE ARMY.

A.
 SGO-A1

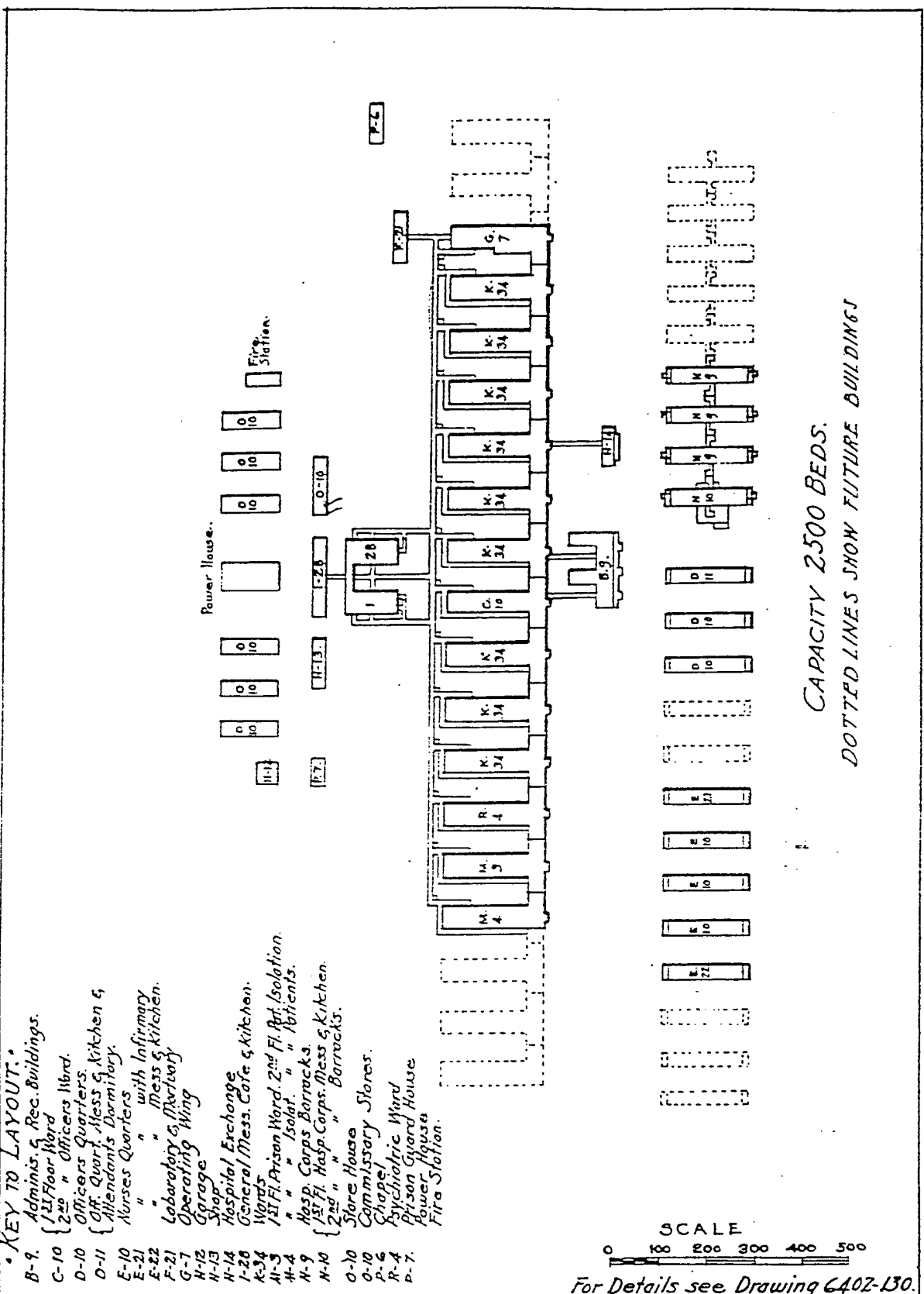

CAPACITY 2500 BEDS.
 DOTTED LINES SHOW FUTURE BUILDING

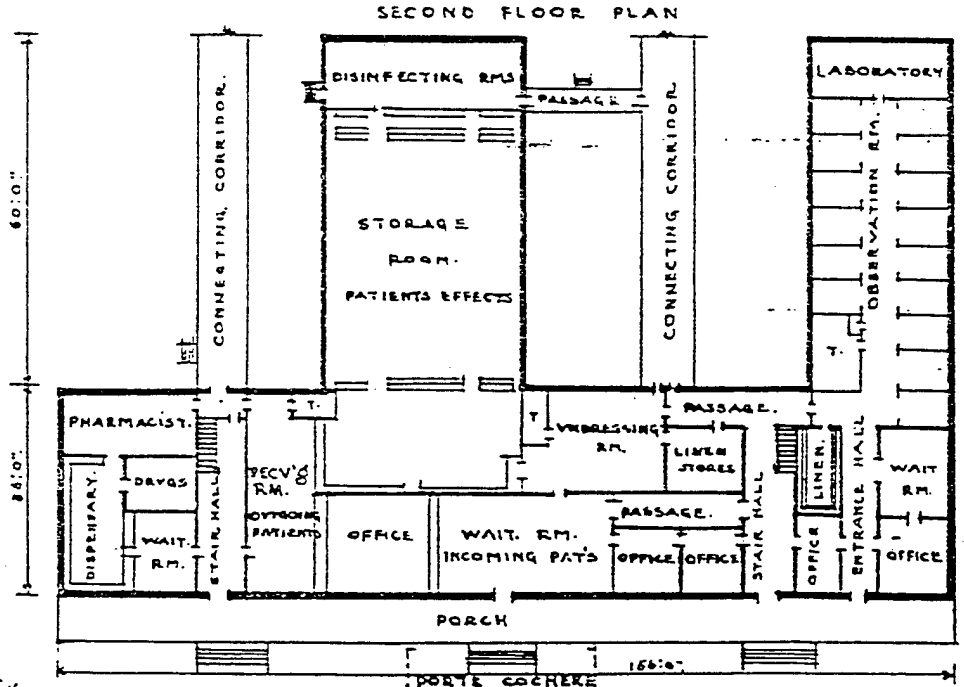
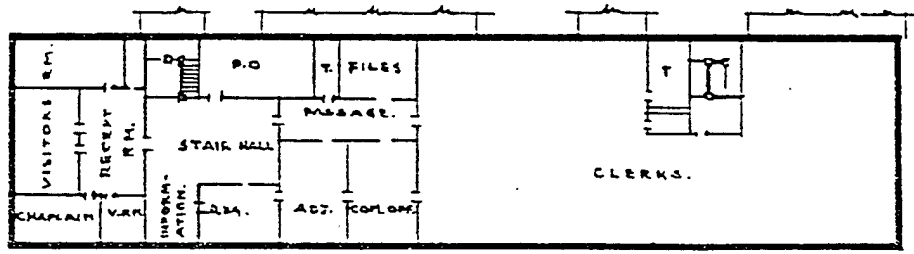
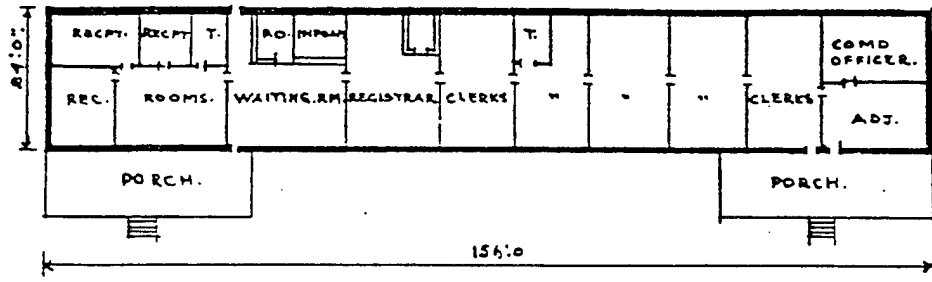
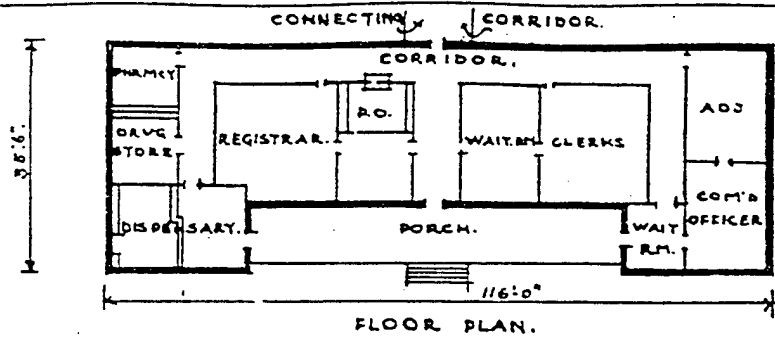

SCALE 1/8" = 1'-0" 24 FIRST FLOOR PLAN

FOR DETAILS SEE DRWG. Z

CONSTRUCTION DIVISION OF THE ARMY.
 TYPICAL HOSPITAL BUILDINGS.
 CONSTRUCTED FOR THE
 SURGEON GENERAL OF THE ARMY.

SGO-B
 B
 ADMINISTRATION

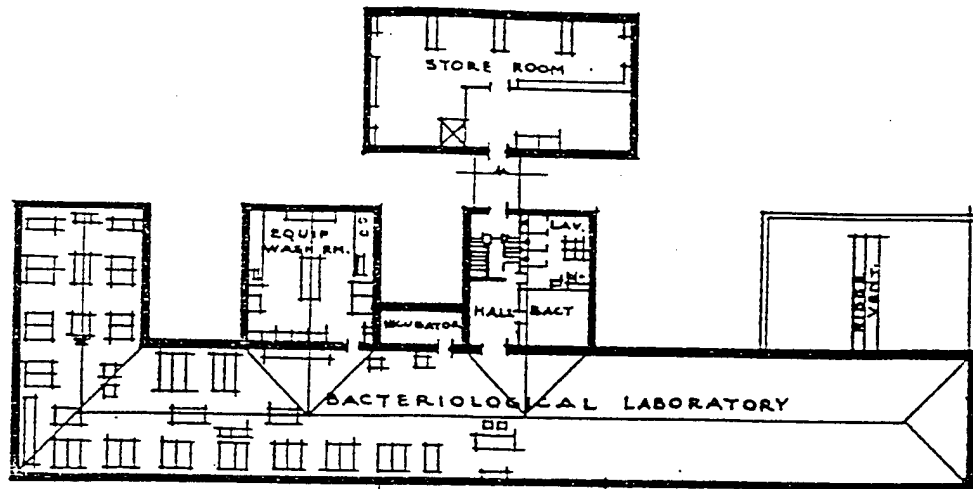

SECOND FLOOR PLAN

F14

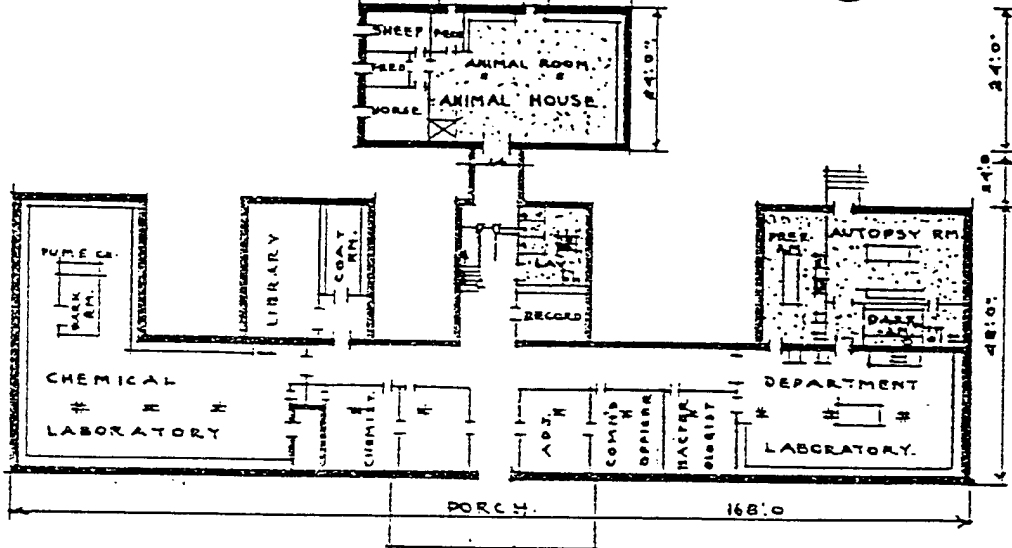

FIRST FLOOR PLAN

DEPARTMENT LABORATORY

F15

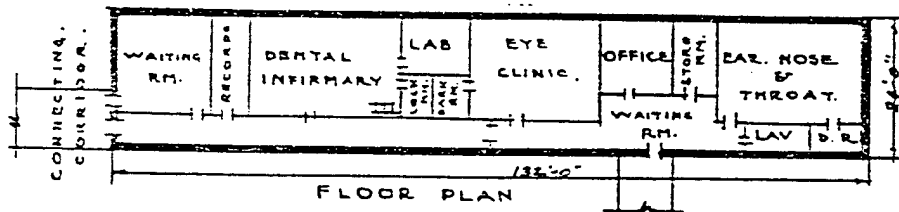

FLOOR PLAN

EYE, EAR, NOSE & THROAT CLINIC
DENTAL INFIRMARY

F16

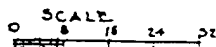

FOR DETAILS SEE DRWG. Z

CONSTRUCTION DIVISION OF THE ARMY.
TYPICAL HOSPITAL BUILDINGS.
CONSTRUCTED FOR THE
SURGEON GENERAL OF THE ARMY.

SGO-F
F.
LABORATORY

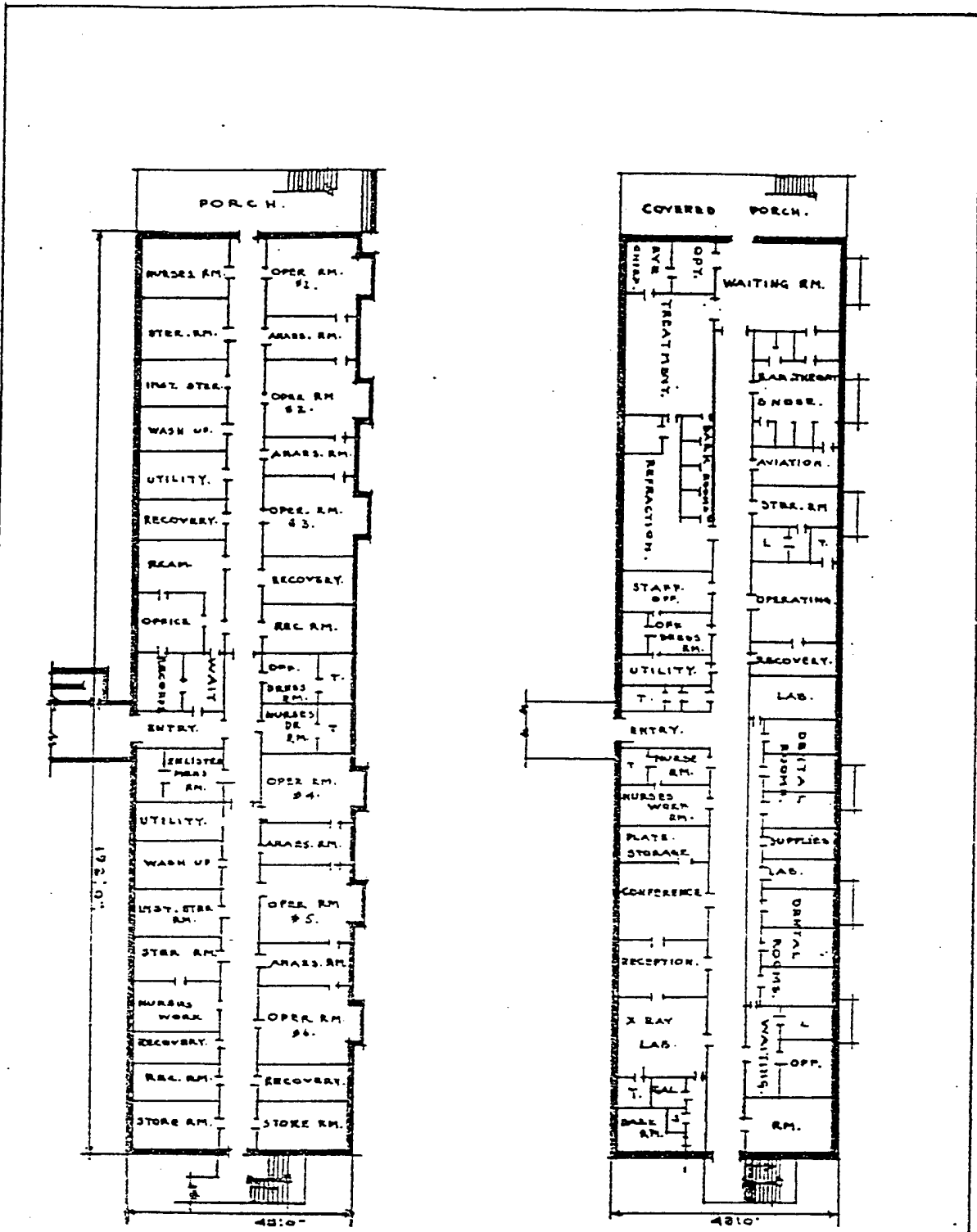

FIRST FLOOR PLAN.

SECOND STORY PLAN.

OPERATING PAVILION



SCALE
0 8 16 24 32

FOR DETAILS SEE DRWG. Z

CONSTRUCTION DIVISION OF THE ARMY.
TYPICAL HOSPITAL BUILDINGS.
CONSTRUCTED FOR THE
SURGEON GENERAL OF THE ARMY

SGO-G
G
OPERATING PAY.

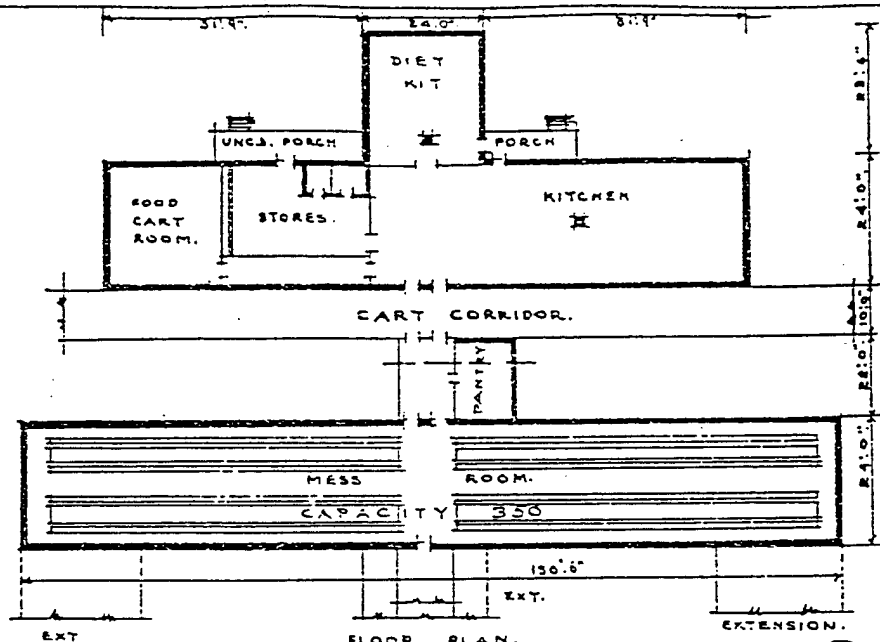

FLOOR PLAN
KITCHEN & MESS ROOM.

11

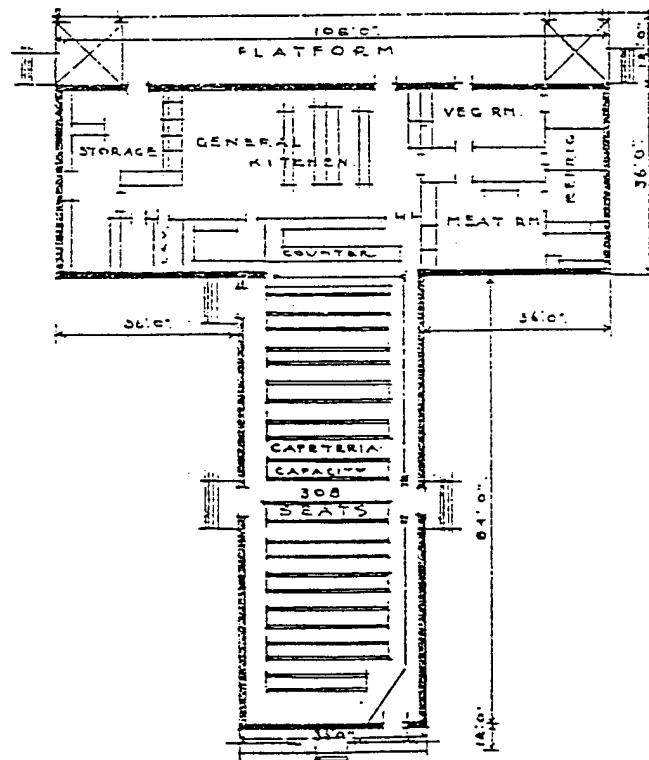

GENERAL MESS & KITCHEN
CAPETERIA SERVICE.

132

SCALE
0 1 2 3 4

FOR DETAILS SEE DRWG. Z

CONSTRUCTION DIVISION OF THE ARMY.
TYPICAL HOSPITAL BUILDINGS.
CONSTRUCTED FOR THE
SURGEON GENERAL OF THE ARMY.

840-I1

•I•

840-I32

KITCHEN+MESS

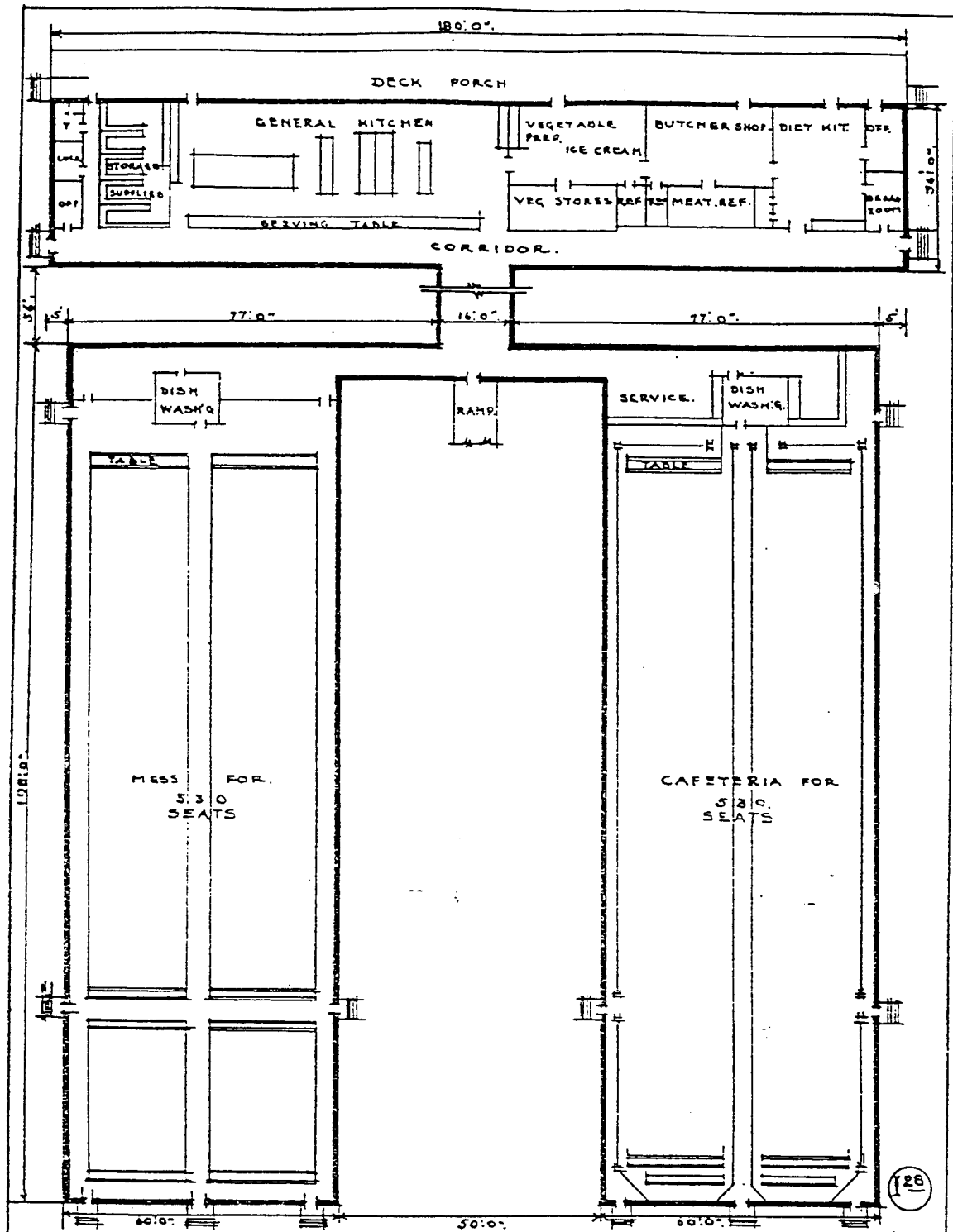

FLOOR PLAN.
 GENERAL MESS & KITCHEN
 SCALE 0 8 11 29 32
 FOR DETAILS SEE DRNG. Z

CONSTRUCTION DIVISION OF THE ARMY
 TYPICAL HOSPITAL BUILDINGS.
 CONSTRUCTED FOR THE
 SURGEON GENERAL OF THE ARMY.

SGO-I28
 .I.
 KITCHEN+MESS.

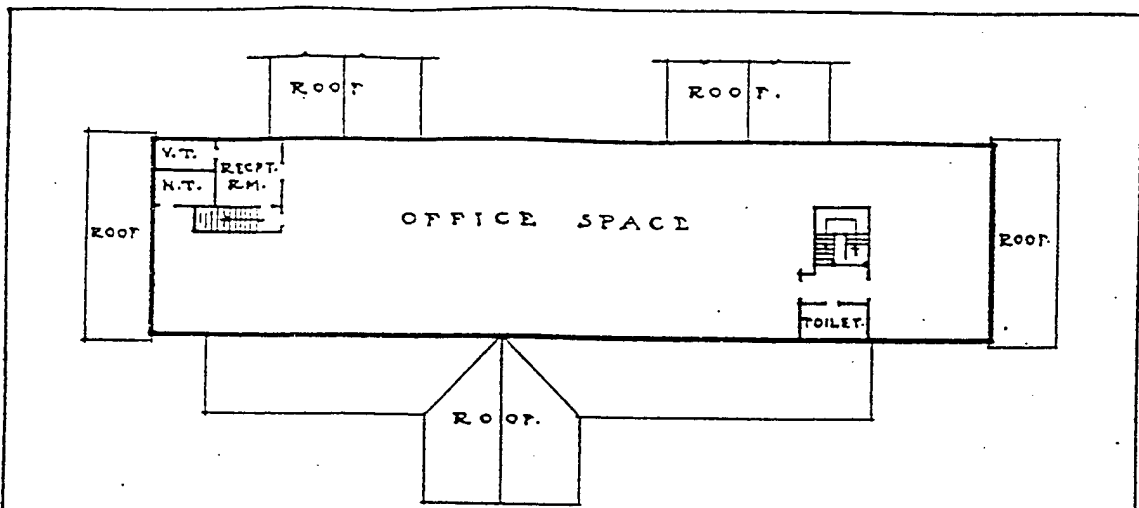

· SECOND FLOOR PLAN ·

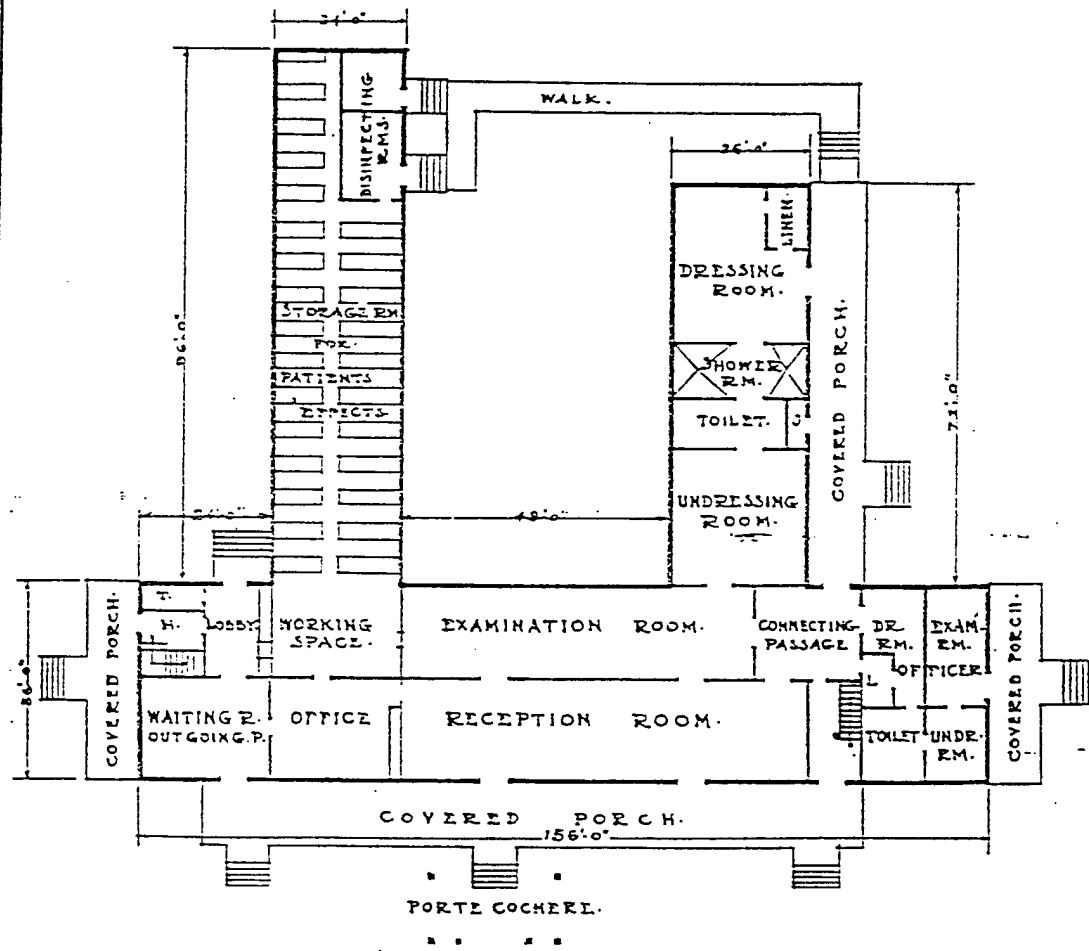

· FIRST FLOOR PLAN ·

SCALE
0 4 8 12 16 20 24 28 32

FOR DETAILS SEE DRWG. Z

(JIS)

CONSTRUCTION DIVISION OF THE ARMY. TYPICAL HOSPITAL BUILDINGS. CONSTRUCTED FOR THE SURGEON GENERAL OF THE ARMY.

SGO-J
·J·
RECEIVING BLDG

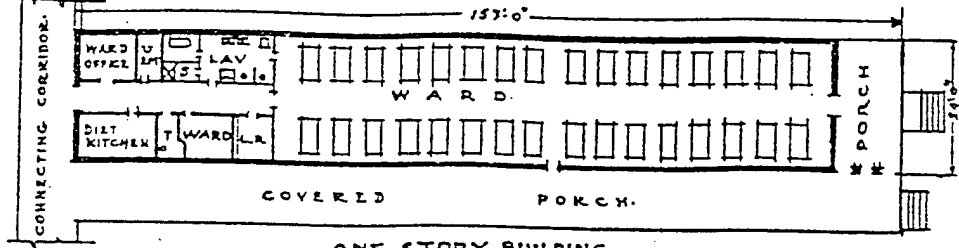

ONE STORY BUILDING
FLOOR PLAN. WARD AND LAVATORY.
REVISED.

(K1)

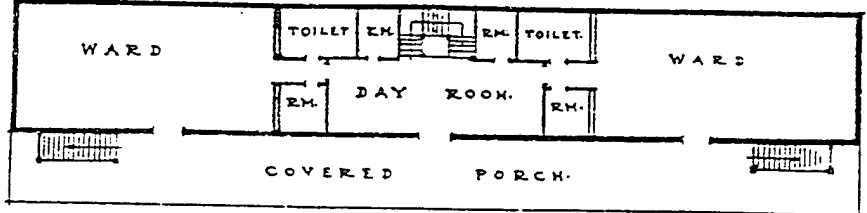

SECOND FLOOR PLAN.

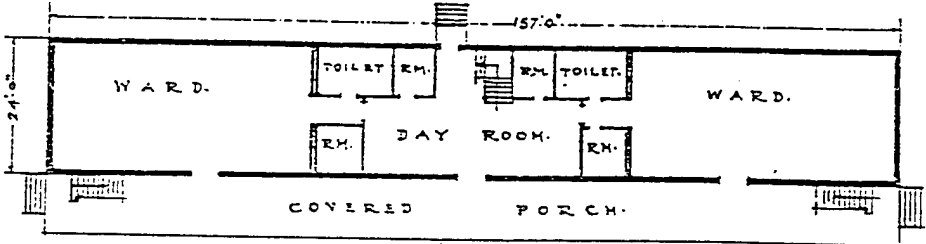

FIRST FLOOR PLAN. WARD BARRACK.

(K3)

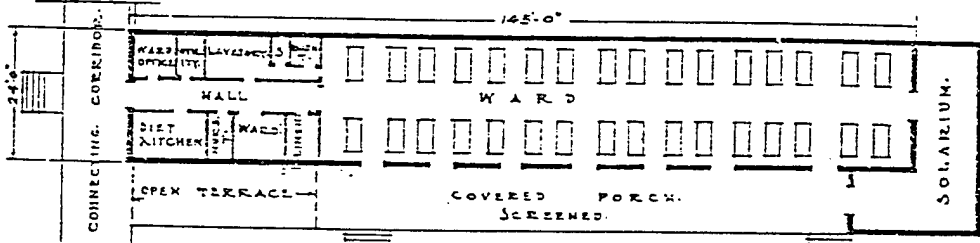

ONE STORY BUILDING
FLOOR PLAN. TUBERCULOSIS WARD

(K5)

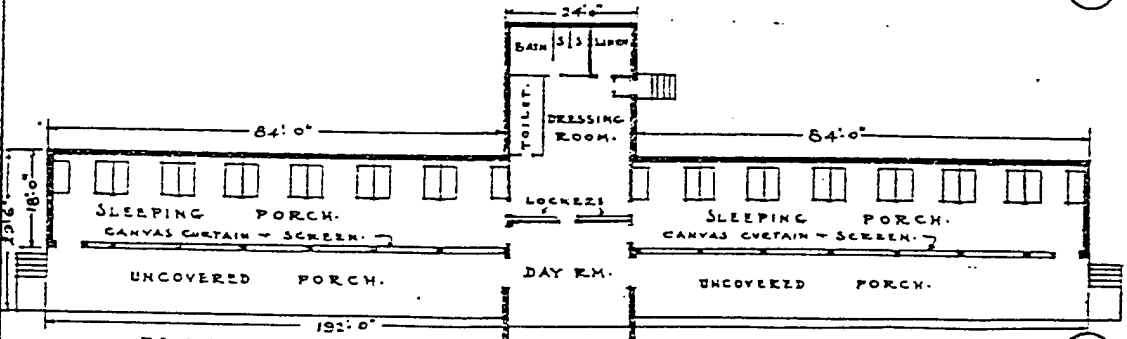

FLOOR PLAN. ONE STORY BUILDG.

TUBERCULOSIS WARD.

(K4)

CONSTRUCTION DIVISION OF THE ARMY.
TYPICAL HOSPITAL BUILDINGS.
CONSTRUCTED FOR THE
SURGEON GENERAL OF THE ARMY.

SGO K-1
K
WARD.

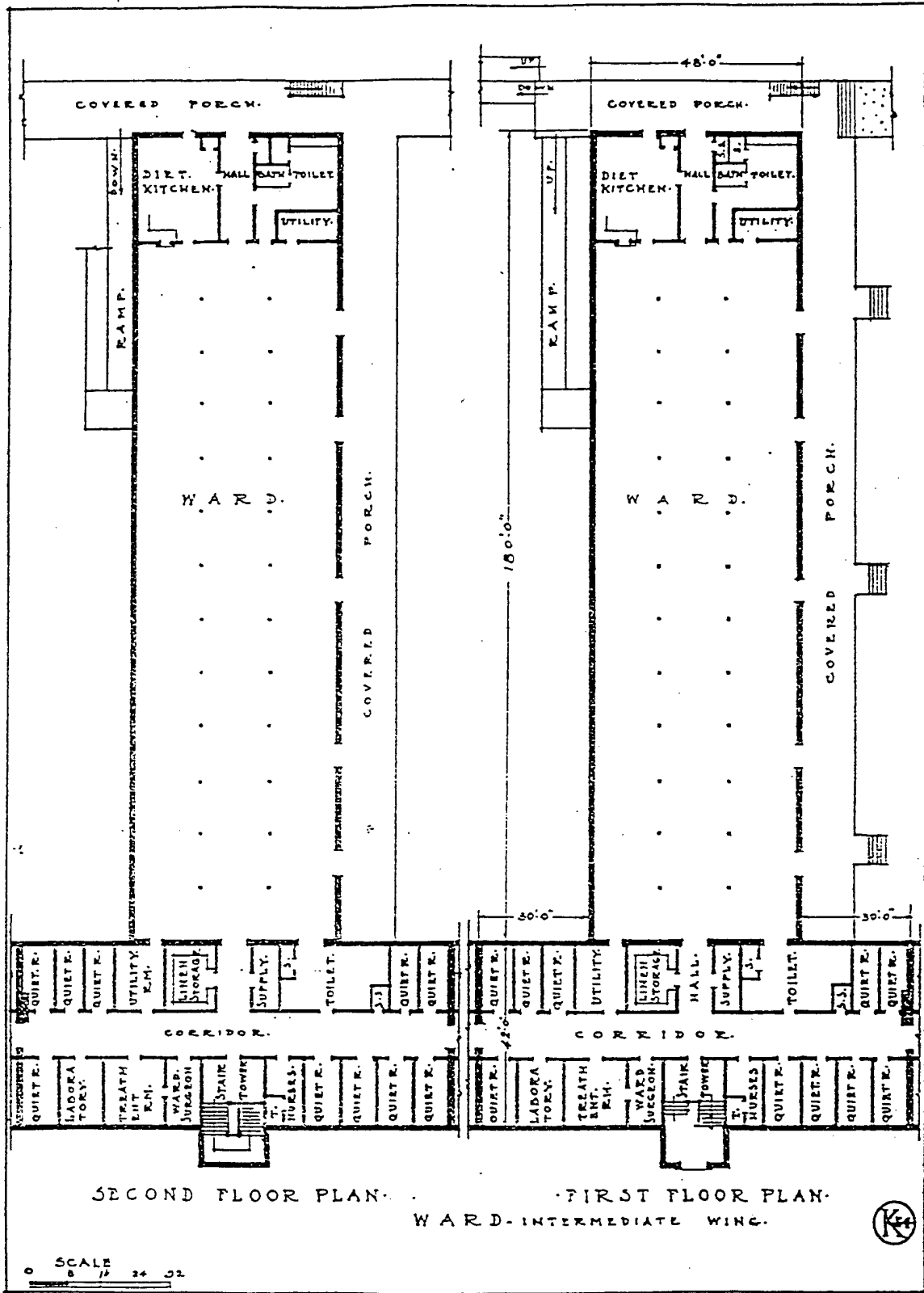

CONSTRUCTION DIVISION OF THE ARMY.
 TYPICAL HOSPITAL BUILDINGS.
 CONSTRUCTED FOR THE
 SURGEON GENERAL OF THE ARMY.

SGO-K2A
 •K•
 HEAD HOUSETYPE
 WARD.

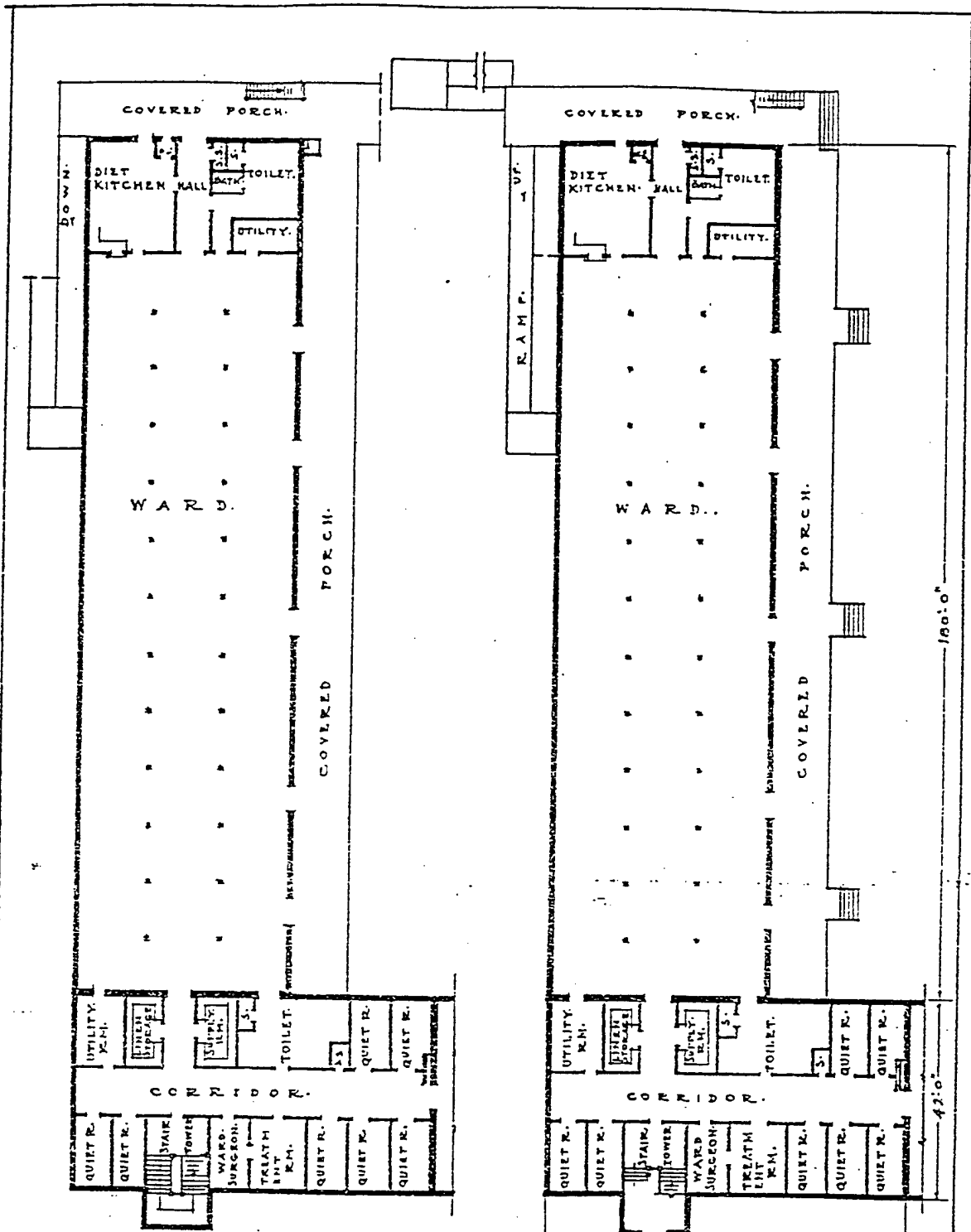

SECOND FLOOR PLAN

FIRST FLOOR PLAN

WARD, LEFT END WING.

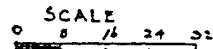

K35

FOR DETAILS SEE DRWG. Z

CONSTRUCTION DIVISION OF THE ARMY.
 TYPICAL HOSPITAL BUILDINGS.
 CONSTRUCTED FOR THE
 SURGEON GENERAL OF THE ARMY

SGO-K85
 •K•
 HEAD HOUSETYPE
 WARD.

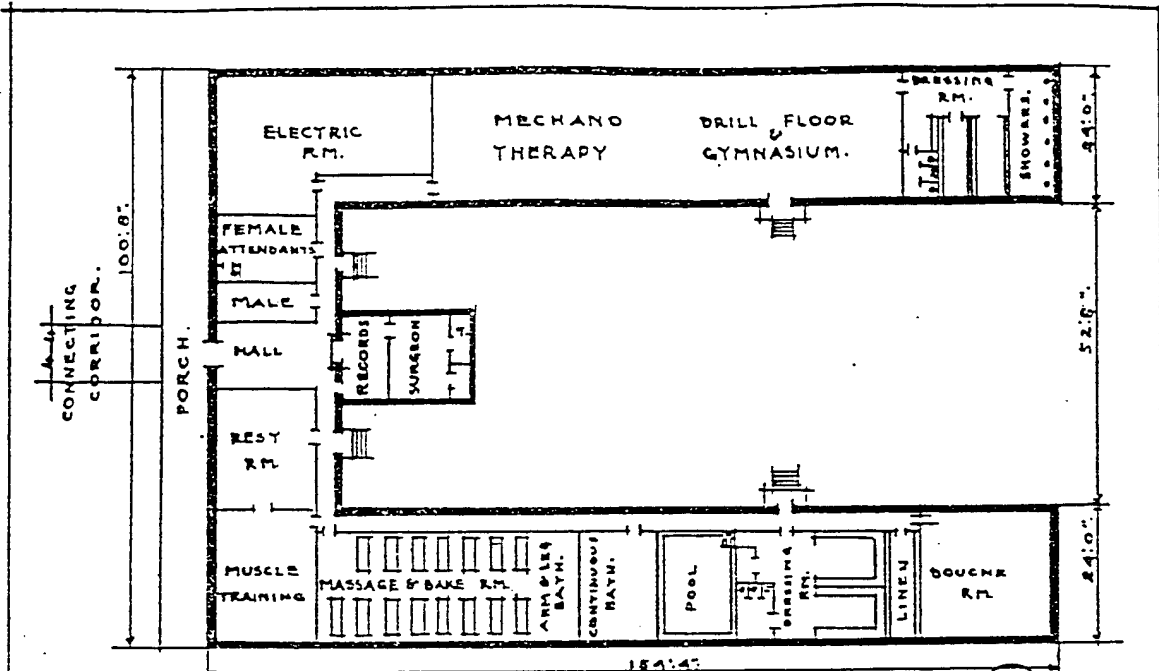

PHYSICAL THERAPY BUILDING. (S)

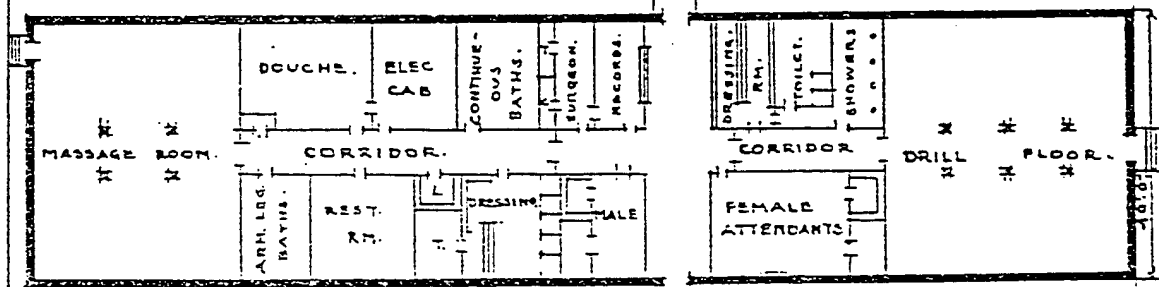

FOR 1000 BED HOSPITAL	225' 0"
1500	244' 0"
2000	285' 0"

PHYSICAL THERAPY BUILDING. (S1)

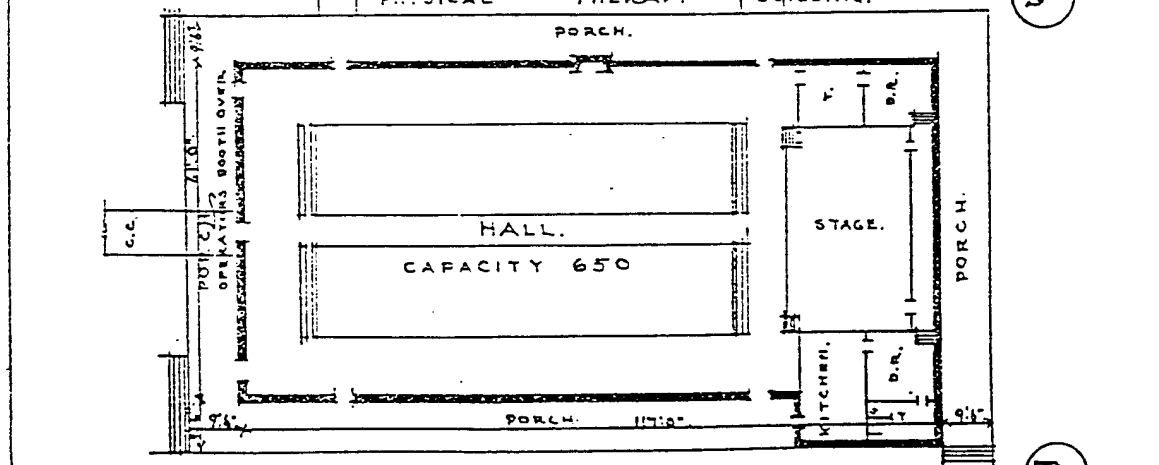

FLOOR PLAN. AMUSEMENT HALL FOR DETAILS SEE DRWG-Z (T)

SCALE 8 16 24 32

CONSTRUCTION DIVISION OF THE ARMY.
 TYPICAL HOSPITAL BUILDINGS.
 CONSTRUCTED FOR THE
 SURGEON GENERAL OF THE ARMY.

SGO	SGO
S.T.	S.T.
PHYS. THERAPY	AMUSEMENT BLDG.

SCHEDULE - BUILDING.

Length of Building	Number of Bents	Ward		Men to a Bent
		Number	Length of Ward	
98'-0"	14	5	35'	15
112'-0"	16	7	49'	21
126'-0"	18	9	63'	27

NOTE:—

35'-0" Ward to have but 1 flue,
49'-0" and 63'-0" wards to have
2 flues.

HOSPITAL.

Scale: 1/8" = 1'-0"

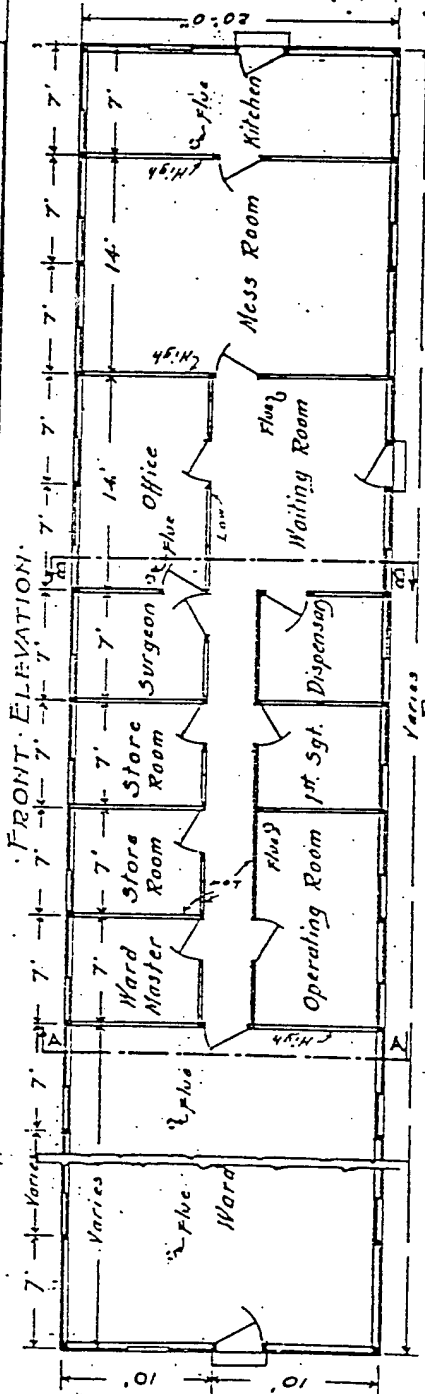
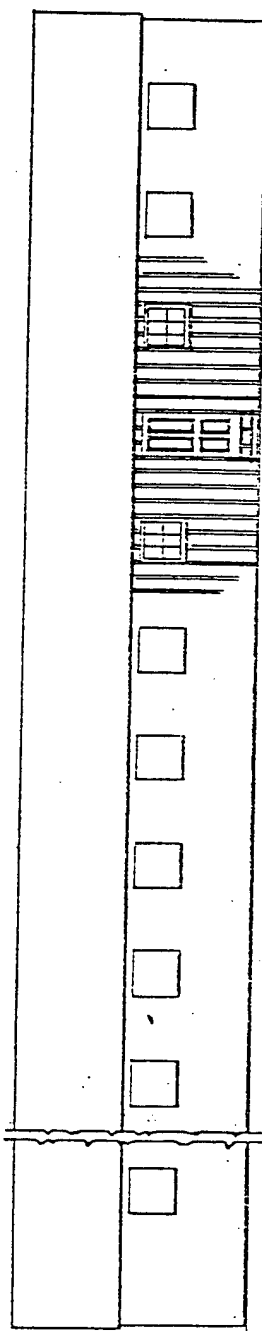
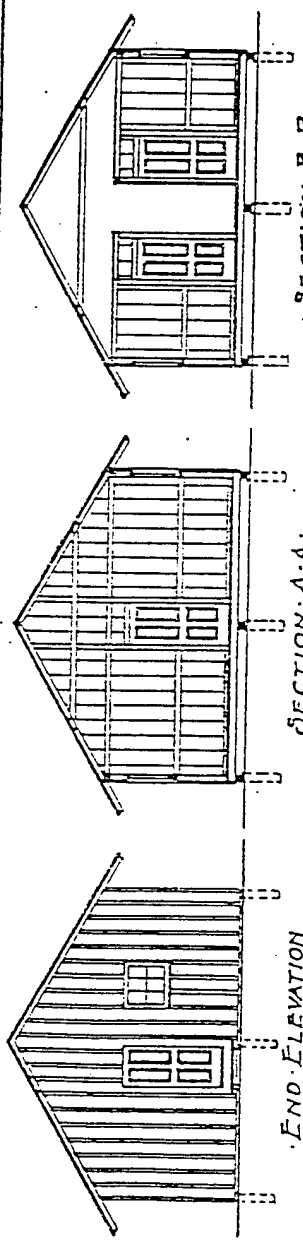

TEMPORARY BUILDINGS.
FOR
MOBILIZATION CAMPS.

SCHEDULE OF BUILDINGS

Length of Bldg.	Number of Doors to Bldg.	Ward Room		
		Length	Number of Benches	Number of Men to a Bench
49'-0"	7	42'	6	12
63'-0"	9	54'	8	16
77'-0"	11	70'	10	20
91'-0"	13	84'	12	24

NOTE:

The 49'-0" building has no outside doors on sides of ward room, but only on end. All partitions extend to the roof.

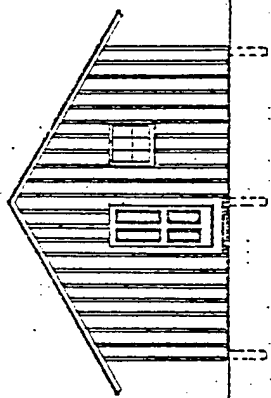

END ELEVATION

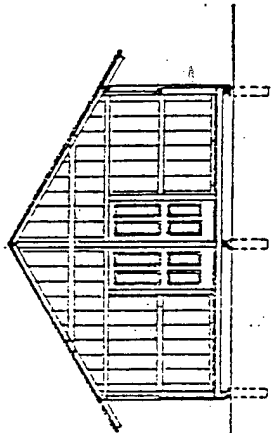

SECTION

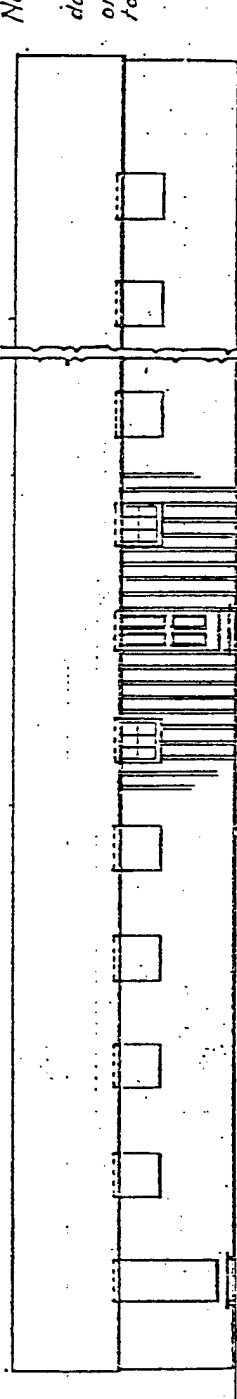

FRONT ELEVATION

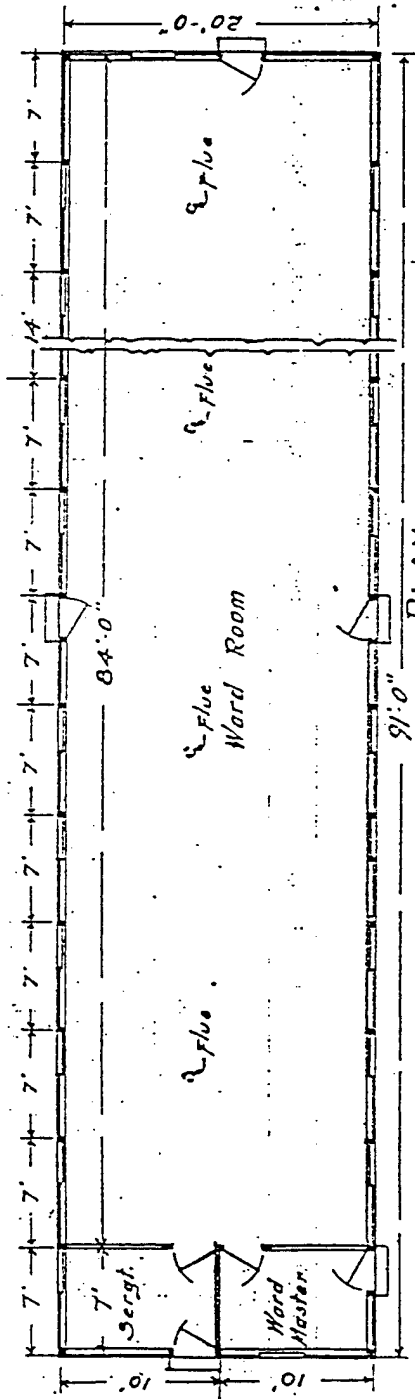

PLAN

WARD BUILDING

Scale in Feet

TEMPORARY BUILDINGS

FOR

MOBILIZATION CAMPS

Category: INDUSTRIAL

Type 5 a: Maintenance and Repair Shops

Description:

Maintenance and repair shops were support facilities needed to maintain an installation's buildings, livestock, and equipment. Maintenance and repair shops were built at all installations; the type of shops varied and depended on the installation mission, the technology of the time, and the evolution of logistical support. Maintenance and repair facilities were usually small, one-story, utilitarian buildings that housed a variety of functions and provided work space for maintenance tasks. Maintenance and repair shops generally were located in a secondary service area on Army posts, apart from the main cantonment area. The maintenance and repair shops described in this section are those necessary for the daily operation of installations with non-manufacturing missions; the specialized maintenance and repair shops required for industrial manufacturing are described in the next section of this category.

Evolution:

The earliest general maintenance and repair shops at Army posts were blacksmith, carpenter, wheelwright, and saddler shops. For example, an 1828 plan of Ft. Leavenworth, Kansas, indicates a smith's shop, and an 1867 plan of Ft. Riley, Kansas, depicts carpenter, saddler, and blacksmith shops.¹ Generally, the Quartermaster Department was charged with maintaining supplies, buildings, and animals. During the mid-nineteenth century, the most important shop was the blacksmith shop where horses were shod and a variety of metal implements mended. Second in importance to the blacksmith, was the wheelwright, who mended wagon wheels. Wagon trains transported supplies to the dispersed western fortification.

The Quartermaster Department did not include plans for maintenance and repair shops in regulations proposed in 1860 or 1872. The early and mid-nineteenth century shop buildings generally were constructed of wood frame and were not intended to be permanent buildings. As the Army consolidated its troops into larger garrisons at the end of the nineteenth century, masonry shops buildings were built at selected installations. In 1892, the Quartermaster Department issued a standardized plan for a Quartermaster Shop. The same utilitarian plan for shop buildings continued in use until World War I and was issued with 23 variations. Masonry was the preferred material, though wood frame also was used. The one-story shop buildings had gable or hipped roofs, regular openings, and interior brick chimneys. The late nineteenth- and early twentieth-century shops usually featured segmental-arch window and door frames, while the later shops displayed rectangular openings. In 1915, the Quartermaster Department issued a

¹ Edward DeZurko, "A Report and Remarks on Cantonment Leavenworth", *Kansas Historical Quarterly* XV, No. 4, November 1947, 354; National Archives and Records Administration, Cartographic Branch, Record Group 77, Drawer 29.

standard plan for a shop with galvanized corrugated steel roof and walls with paired, swinging doors in one gable end.²

Maintenance and repair shops varied in size and functions. In general, shop buildings were designed as utilitarian structures that could serve multiple functions. During the late nineteenth and early twentieth centuries, maintenance and repair shops could serve the blacksmith, wheelwright, carpenter; the blacksmith alone; or, the blacksmith, plumber and tinner, painter, and carpenter. The same building type could be used as an artillery workshop for the blacksmith, saddler, and wheelwright, or as an ordnance workshop with a forge and workshop space.

The functions of Quartermaster shops evolved between the late nineteenth century and the end of the 1930s. By the turn-of-the-century, railroads had replaced wagon trains and wheelwrights were no longer needed. During the inter-war period, the Army began to use trucks to transport supplies. The construction of blacksmith shops and quartermaster garages illustrates that both horses and motorized vehicles had roles on Army posts during the 1930s.

During the wave of construction following the enactment of Public Law 45 in 1926, which authorized the Secretary of War to deposit funds from the sale of unneeded installations into a Military Post Construction Fund for new construction, the appearance and size of maintenance and repair shops underwent noticeable changes. Maintenance and repair shops of this era generally were brick utilitarian structures with industrial sash windows; they were bigger than their predecessors to accommodate the repair of larger equipment or motorized vehicles. The Army posts of this era often required several shop buildings to service the increased numbers of structures and amount of equipment. The basic maintenance and repair shop building design could accommodate a variety of uses, including motor vehicle repair shops, aviation repair facilities, and utility buildings. On Army posts, maintenance and repair buildings continued to be located in a separate service area, while on Army Air Corps fields, maintenance and repair shops were integrated into the installation plan along the flight line near the airplane hangars.

Association:

The construction of maintenance and repair shops was related directly to the evolution of logistical support for military missions. The types of maintenance and repair activities depended on installation maintenance needs, transportation technology, and weapons technology.

Maintenance and repair buildings generally are utilitarian structures located in the service areas of an installation. They usually do not possess individual historic or architectural significance; however, they may be contributing buildings in an historic district if they are within the boundaries of a concentration of buildings from the district's period of significance and retain sufficient exterior integrity to convey the period of significance. The significance of the historic district is the key factor in determining how important support facilities, such as repair and maintenance shops, are to the character of the district. For a district eligible for its design, the

² NARA, Cartographic Branch, RG 77, Standard Plans of Army Post Buildings, 1891-1918, Pi NM-19, Entry 411, Plans 59, 397.

shop buildings may have less relevance, whereas for a district eligible for its ability to represent a development in military technology, such as aviation, then the shop buildings, such as airplane repair shops, are more relevant to the district's significance.

Integrity:

To possess integrity as defined by the National Register, maintenance and repair shops should retain most of the design features and external construction materials from their periods of construction. Character-defining features of surviving nineteenth- and early twentieth-century shops include rectangular shape, gable or hip roof form, masonry exterior materials, chimneys, and regular patterns of openings, often set in segmental-arch frames. Twentieth-century maintenance and repair shops exhibit more variations. Army motor vehicle and aircraft repair shops from this later period generally are rectangular, masonry buildings with gable roofs, corner piers, and industrial sash windows. Twentieth-century shops often retain their original functions, but usually have undergone modifications to accommodate changes in equipment. Exterior elements that may have been modified include original window and door openings. In the event of subsequent additions or renovations, the building may have integrity if it retains the majority of the features that illustrate its design in terms of massing, proportion, pattern of windows and doors, materials, and architectural details.



1930's Maintenance & Repair Shop Complex at Fort Gillem, Georgia

Section of Thor Side
Scale 3/16" dia.

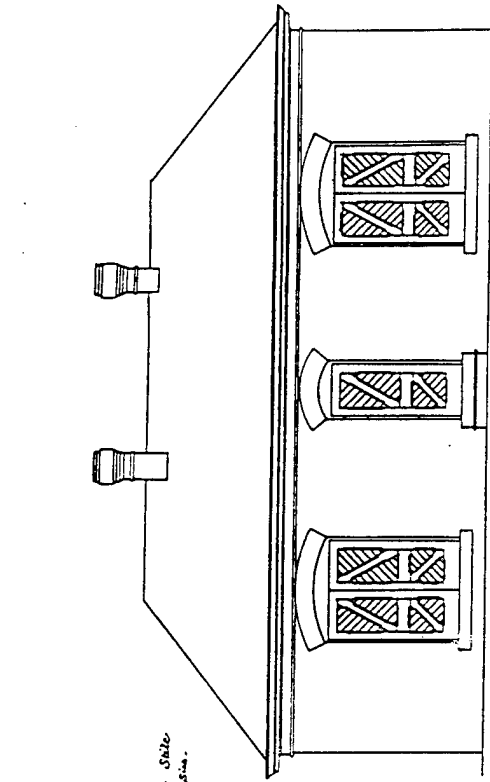

Front Elevation

Battery Workshops

Artillery Post, Fort Riley, Kans.

Prepared under the direction of

Capt. Geo. B. Pond, A. Q. M., U.S.A.

Scale: 1/4" = 1'

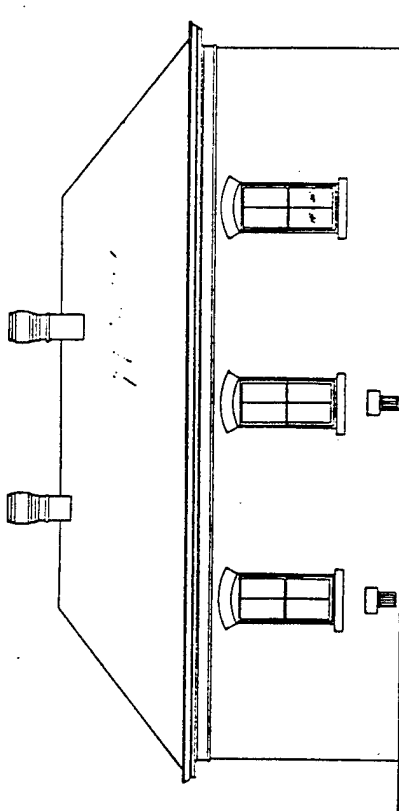

Rear Elevation

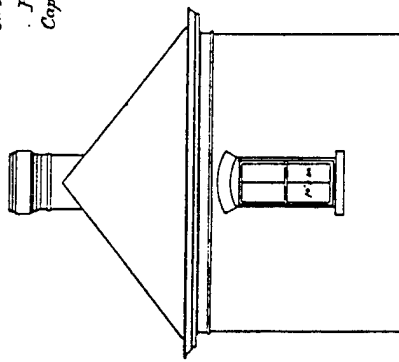

End Elevation

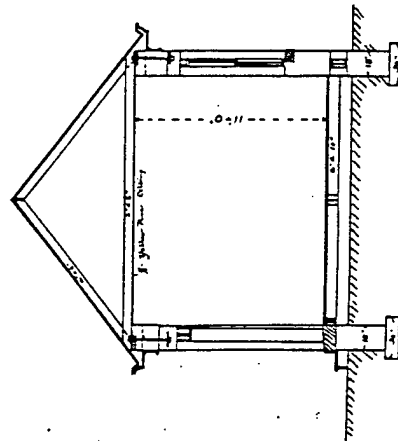

Transverse Section
across Wheelwright & Saddler Shops.

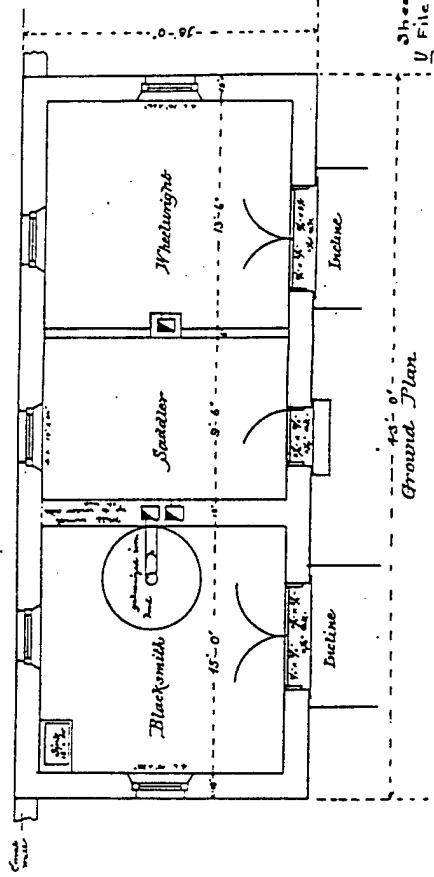

Ground Plan

Sheet-2
U File A14-2

1895-1897
1 3 6 1 1 3 6 6

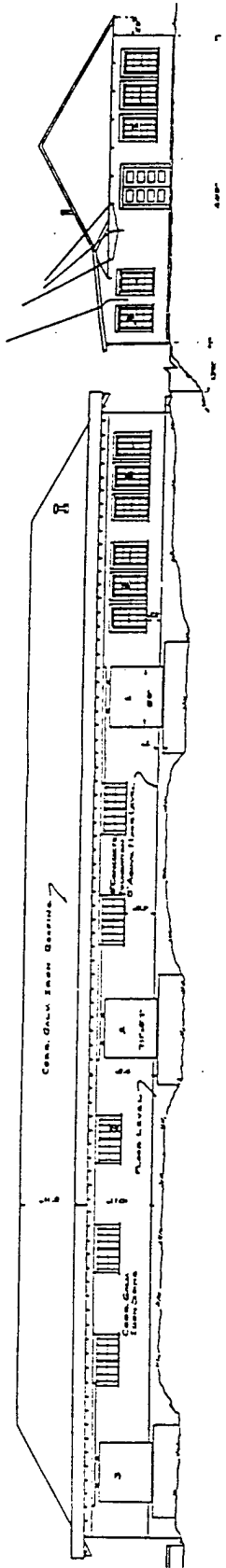

EAST ELEVATION
Scale: 1/8" = 1'-0"

NORTH ELEVATION
Scale: 1/8" = 1'-0"

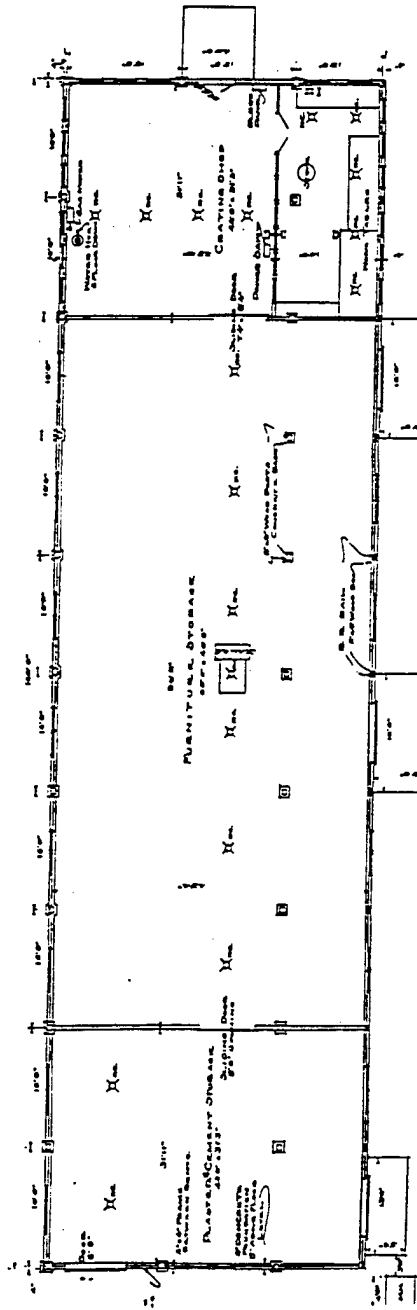

FLOOR PLAN CREATING SHOP
Scale: 1/8" = 1'-0"
CHECKED TO DATE: FEBRUARY 28, 1950

UTILITIES SECTION		QMC		FORT BILLY, MISS.	
PRESENT PACKING & CREATING SHOP		BUILDING NO. 230-311			
DATE: 10/20/49	BY: [Signature]	QUANTITY NO. 130	APPROVED BY:		
DATE: 10/20/49	BY: [Signature]	PLAN NO. AF-12	MAJOR: W.J. BERNER		
DATE: 10/20/49	BY: [Signature]		APPROVED BY:		
			CAPTAIN UTILITIES OFFICER:	GUY V. HANCOCK	
			SERGEANT GENERAL USA (COMMANANT)		

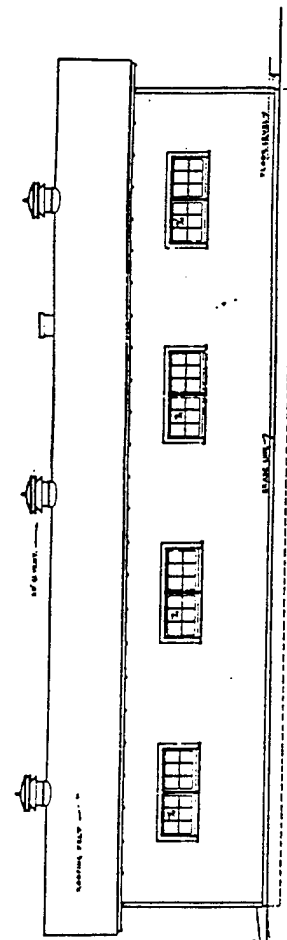

- SIDE-ELEVATION -
SCALE: 1/8"

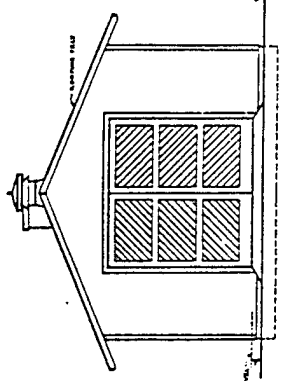

- END-ELEVATION -
SCALE: 1/8"

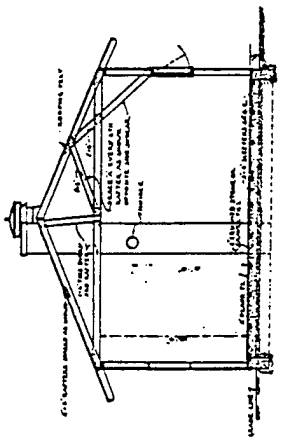

- SECTION-A-A -
SCALE: 1/8"

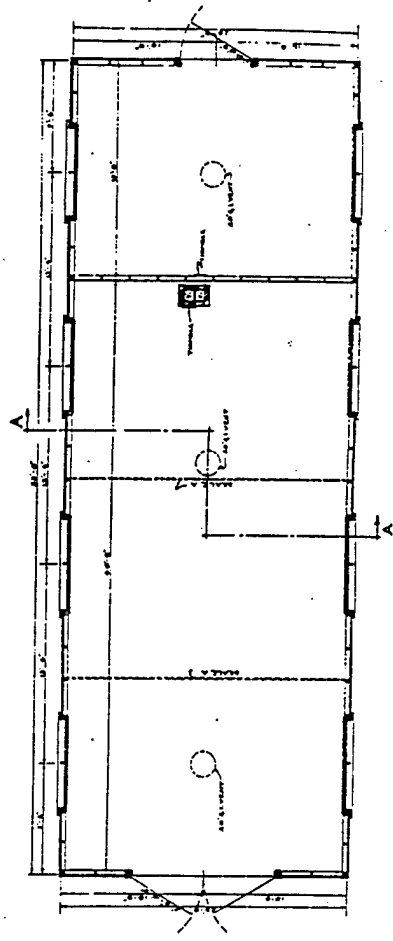

- PLAN -
SCALE: 1/8"

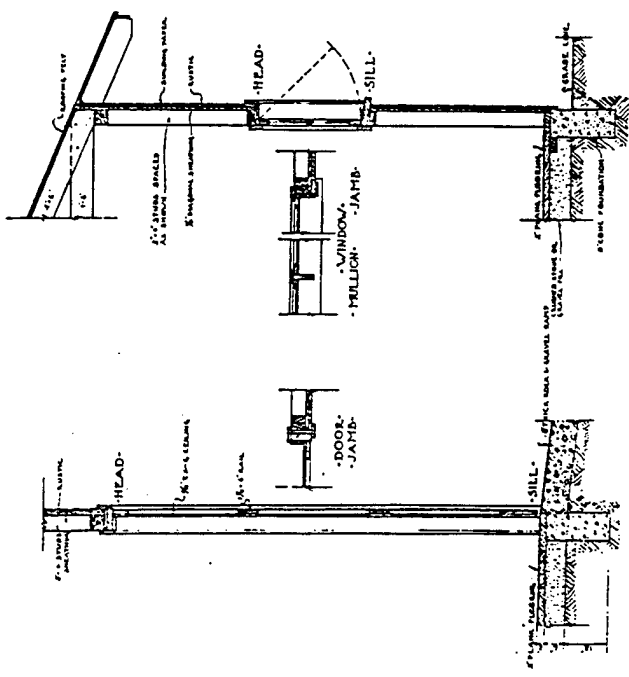

- SECTION -
THRO-WINDOW -
SCALE: 1/8"

- SECTION -
THRO-DOOR -
SCALE: 1/8"

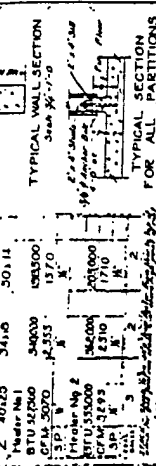
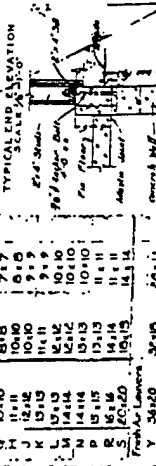
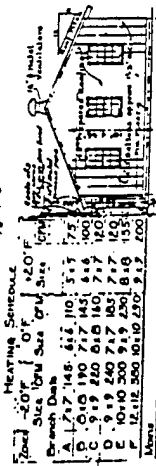
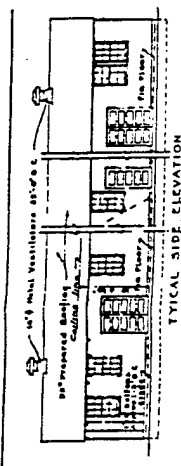

Heating Schedule
 20° F
 120° F
 140° F
 160° F
 180° F
 200° F
 220° F
 240° F
 260° F
 280° F
 300° F
 320° F
 340° F
 360° F
 380° F
 400° F
 420° F
 440° F
 460° F
 480° F
 500° F
 520° F
 540° F
 560° F
 580° F
 600° F
 620° F
 640° F
 660° F
 680° F
 700° F
 720° F
 740° F
 760° F
 780° F
 800° F
 820° F
 840° F
 860° F
 880° F
 900° F
 920° F
 940° F
 960° F
 980° F
 1000° F

FOR ALL PARTITIONS
 See 30-10
 See 30-11
 See 30-12
 See 30-13
 See 30-14
 See 30-15
 See 30-16
 See 30-17
 See 30-18
 See 30-19
 See 30-20
 See 30-21
 See 30-22
 See 30-23
 See 30-24
 See 30-25
 See 30-26
 See 30-27
 See 30-28
 See 30-29
 See 30-30
 See 30-31
 See 30-32
 See 30-33
 See 30-34
 See 30-35
 See 30-36
 See 30-37
 See 30-38
 See 30-39
 See 30-40
 See 30-41
 See 30-42
 See 30-43
 See 30-44
 See 30-45
 See 30-46
 See 30-47
 See 30-48
 See 30-49
 See 30-50
 See 30-51
 See 30-52
 See 30-53
 See 30-54
 See 30-55
 See 30-56
 See 30-57
 See 30-58
 See 30-59
 See 30-60
 See 30-61
 See 30-62
 See 30-63
 See 30-64
 See 30-65
 See 30-66
 See 30-67
 See 30-68
 See 30-69
 See 30-70
 See 30-71
 See 30-72
 See 30-73
 See 30-74
 See 30-75
 See 30-76
 See 30-77
 See 30-78
 See 30-79
 See 30-80
 See 30-81
 See 30-82
 See 30-83
 See 30-84
 See 30-85
 See 30-86
 See 30-87
 See 30-88
 See 30-89
 See 30-90
 See 30-91
 See 30-92
 See 30-93
 See 30-94
 See 30-95
 See 30-96
 See 30-97
 See 30-98
 See 30-99
 See 30-100

FOR ALL PARTITIONS
 See 30-10
 See 30-11
 See 30-12
 See 30-13
 See 30-14
 See 30-15
 See 30-16
 See 30-17
 See 30-18
 See 30-19
 See 30-20
 See 30-21
 See 30-22
 See 30-23
 See 30-24
 See 30-25
 See 30-26
 See 30-27
 See 30-28
 See 30-29
 See 30-30
 See 30-31
 See 30-32
 See 30-33
 See 30-34
 See 30-35
 See 30-36
 See 30-37
 See 30-38
 See 30-39
 See 30-40
 See 30-41
 See 30-42
 See 30-43
 See 30-44
 See 30-45
 See 30-46
 See 30-47
 See 30-48
 See 30-49
 See 30-50
 See 30-51
 See 30-52
 See 30-53
 See 30-54
 See 30-55
 See 30-56
 See 30-57
 See 30-58
 See 30-59
 See 30-60
 See 30-61
 See 30-62
 See 30-63
 See 30-64
 See 30-65
 See 30-66
 See 30-67
 See 30-68
 See 30-69
 See 30-70
 See 30-71
 See 30-72
 See 30-73
 See 30-74
 See 30-75
 See 30-76
 See 30-77
 See 30-78
 See 30-79
 See 30-80
 See 30-81
 See 30-82
 See 30-83
 See 30-84
 See 30-85
 See 30-86
 See 30-87
 See 30-88
 See 30-89
 See 30-90
 See 30-91
 See 30-92
 See 30-93
 See 30-94
 See 30-95
 See 30-96
 See 30-97
 See 30-98
 See 30-99
 See 30-100

FOR ALL PARTITIONS
 See 30-10
 See 30-11
 See 30-12
 See 30-13
 See 30-14
 See 30-15
 See 30-16
 See 30-17
 See 30-18
 See 30-19
 See 30-20
 See 30-21
 See 30-22
 See 30-23
 See 30-24
 See 30-25
 See 30-26
 See 30-27
 See 30-28
 See 30-29
 See 30-30
 See 30-31
 See 30-32
 See 30-33
 See 30-34
 See 30-35
 See 30-36
 See 30-37
 See 30-38
 See 30-39
 See 30-40
 See 30-41
 See 30-42
 See 30-43
 See 30-44
 See 30-45
 See 30-46
 See 30-47
 See 30-48
 See 30-49
 See 30-50
 See 30-51
 See 30-52
 See 30-53
 See 30-54
 See 30-55
 See 30-56
 See 30-57
 See 30-58
 See 30-59
 See 30-60
 See 30-61
 See 30-62
 See 30-63
 See 30-64
 See 30-65
 See 30-66
 See 30-67
 See 30-68
 See 30-69
 See 30-70
 See 30-71
 See 30-72
 See 30-73
 See 30-74
 See 30-75
 See 30-76
 See 30-77
 See 30-78
 See 30-79
 See 30-80
 See 30-81
 See 30-82
 See 30-83
 See 30-84
 See 30-85
 See 30-86
 See 30-87
 See 30-88
 See 30-89
 See 30-90
 See 30-91
 See 30-92
 See 30-93
 See 30-94
 See 30-95
 See 30-96
 See 30-97
 See 30-98
 See 30-99
 See 30-100

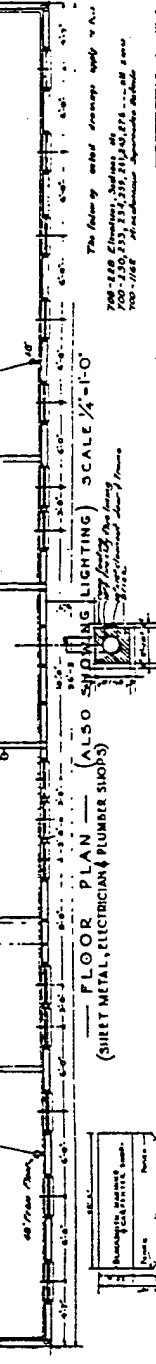
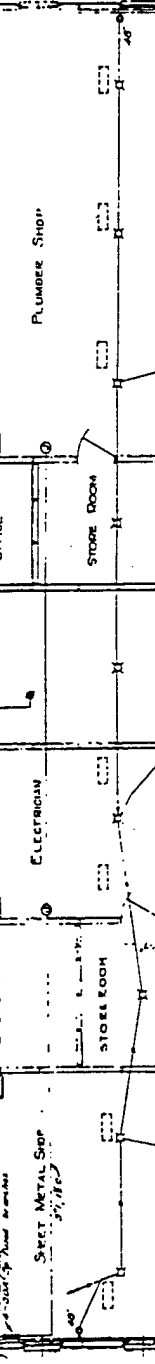
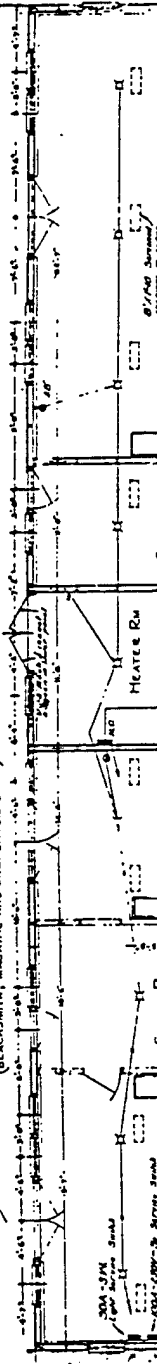
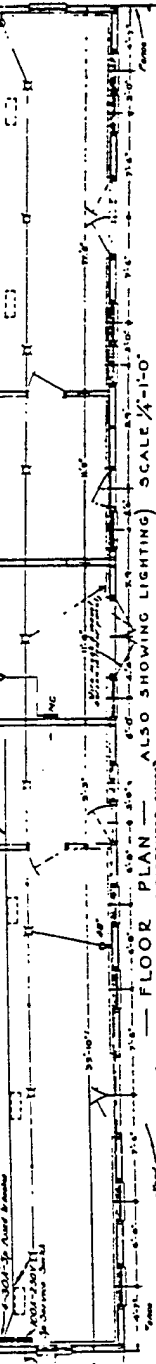
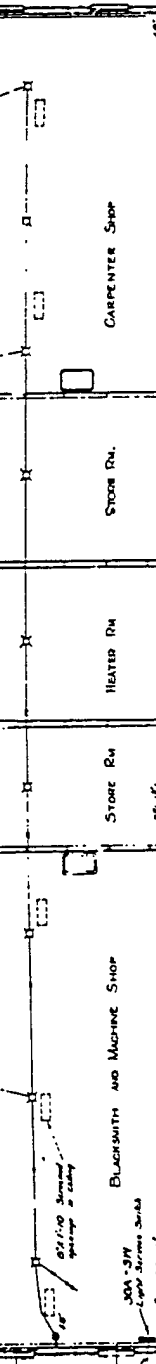
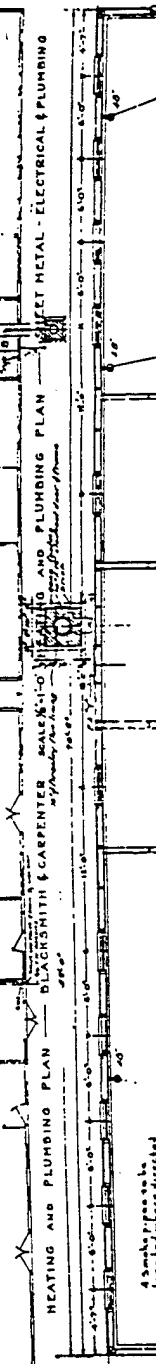
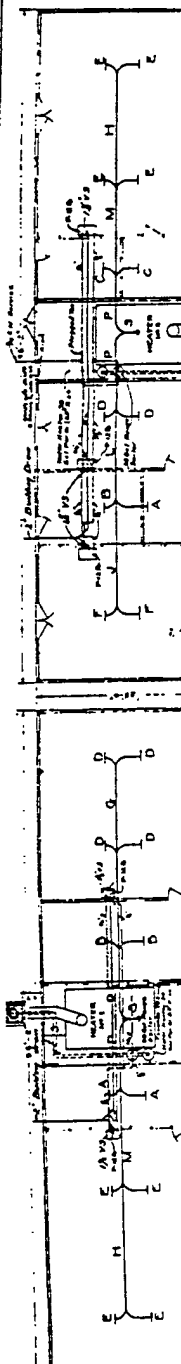

REVISIONS
 1. 11/17/44
 2. 11/17/44
 3. 11/17/44
 4. 11/17/44
 5. 11/17/44
 6. 11/17/44
 7. 11/17/44
 8. 11/17/44
 9. 11/17/44
 10. 11/17/44
 11. 11/17/44
 12. 11/17/44
 13. 11/17/44
 14. 11/17/44
 15. 11/17/44
 16. 11/17/44
 17. 11/17/44
 18. 11/17/44
 19. 11/17/44
 20. 11/17/44
 21. 11/17/44
 22. 11/17/44
 23. 11/17/44
 24. 11/17/44
 25. 11/17/44
 26. 11/17/44
 27. 11/17/44
 28. 11/17/44
 29. 11/17/44
 30. 11/17/44
 31. 11/17/44
 32. 11/17/44
 33. 11/17/44
 34. 11/17/44
 35. 11/17/44
 36. 11/17/44
 37. 11/17/44
 38. 11/17/44
 39. 11/17/44
 40. 11/17/44
 41. 11/17/44
 42. 11/17/44
 43. 11/17/44
 44. 11/17/44
 45. 11/17/44
 46. 11/17/44
 47. 11/17/44
 48. 11/17/44
 49. 11/17/44
 50. 11/17/44
 51. 11/17/44
 52. 11/17/44
 53. 11/17/44
 54. 11/17/44
 55. 11/17/44
 56. 11/17/44
 57. 11/17/44
 58. 11/17/44
 59. 11/17/44
 60. 11/17/44
 61. 11/17/44
 62. 11/17/44
 63. 11/17/44
 64. 11/17/44
 65. 11/17/44
 66. 11/17/44
 67. 11/17/44
 68. 11/17/44
 69. 11/17/44
 70. 11/17/44
 71. 11/17/44
 72. 11/17/44
 73. 11/17/44
 74. 11/17/44
 75. 11/17/44
 76. 11/17/44
 77. 11/17/44
 78. 11/17/44
 79. 11/17/44
 80. 11/17/44
 81. 11/17/44
 82. 11/17/44
 83. 11/17/44
 84. 11/17/44
 85. 11/17/44
 86. 11/17/44
 87. 11/17/44
 88. 11/17/44
 89. 11/17/44
 90. 11/17/44
 91. 11/17/44
 92. 11/17/44
 93. 11/17/44
 94. 11/17/44
 95. 11/17/44
 96. 11/17/44
 97. 11/17/44
 98. 11/17/44
 99. 11/17/44
 100. 11/17/44

Category: INDUSTRIAL

Type 5 b: Manufacturing Complexes

Description:

Between 1790 and 1940, the military constructed manufacturing complexes to supply needed equipment, weaponry, weaponry supplies, and capital items. For most of the time period included in this study, military-operated manufacturing complexes consisted of two types: weapons production and shipbuilding facilities. Structures associated with shipbuilding generally belong to the Navy and are not part of this study. Both Navy and Army manufacturing complexes, however, are characterized by functional design. Army complexes were arranged to facilitate manufacturing processes, from acquiring and storing raw materials, through the manufacturing processes, to storage and shipping of final products. Nineteenth-century industrial buildings that housed different manufacturing processes, except for some specialized processes such as the manufacture of gunpowder, exhibited little exterior differentiation. Nineteenth-century industrial buildings sometimes exhibited classically-inspired architectural ornamentation typical of the era. By the late nineteenth century, as both production technology and the items produced became more complex, industrial buildings grew larger, were tailored to specific manufacturing processes, and exhibited functional designs. Technological developments required either the continual improvement and alteration of older facilities or the construction of new facilities. In general, few manufacturing industrial complexes were designed as complete entities at one time. Generally, they were the result of the evolution of technological advancements over a period of time through the addition of new, larger buildings that embodied construction techniques and architectural expressions popular at the time of their construction.

Evolution:

Arsenals and armories. Between 1790 and 1940, the Army's manufacturing complexes generally consisted of ordnance production, that is weapons and ammunition. The Ordnance Department controlled two types of installations: armories and arsenals. Armories produced small arms, while arsenals stored, repaired, or manufactured other forms of ordnance. When used for manufacturing, arsenals generally concentrated on secondary ordnance items such as cannon carriages or kits for artillerymen. The earliest two armories were located at Springfield, Massachusetts and Harpers Ferry, West Virginia. These two armories were the principal production facilities for muskets, rifles, and other small arms. By the 1840s, the duties of the arsenal had been expanded to powder proofing, repair of guns, weapons testing, and production of percussion caps. The Ordnance Department constructed several arsenals during the nineteenth century including Washington Arsenal, Washington, D.C. (operational between 1802 and 1861), Frankford Arsenal, Pennsylvania (established 1816), Watervliet Arsenal, New York (1813), Watertown Arsenal, Massachusetts (1816). and Rock Island Arsenal, Illinois (1862).

Nineteenth-century industrial buildings generally were characterized by two-story masonry buildings, most often brick or stone, with large window openings to allow light. Little exterior differentiation was needed for buildings housing different manufacturing processes, except for

some specialized processes such as the manufacture and storage of gunpowder. Nineteenth century industrial buildings were surprisingly generic no matter what was produced inside of them.

Perhaps the most talented arsenal designer in the Ordnance Department was T. J. Rodman who designed Watertown Arsenal and Rock Island Arsenal. Rodman organized the arsenal buildings to facilitate production lines for ordnance manufacturing. At Rock Island Arsenal, Rodman's plan consisted of ten shops symmetrically arranged: five shops for an armory to manufacture small arms, and five shops for an arsenal to support a general ordnance manufacturing complex.³ The shop buildings were constructed over a period of twenty years. The earliest buildings were load-bearing masonry. Rodman's design for the arsenal was unified through the use of monumental, classically-inspired design elements, such as templefronts, pilasters, cornices, and quoins, on the ten shop buildings, as well as the residential and administration buildings.

During the late nineteenth century, weapons production technology increased in complexity. In 1888, Watervliet Arsenal was designated as the Army's gun foundry for seacoast and field artillery. The gun factory used new technology in weapons manufacture to produce steel breechloading artillery; the new technology involved constructing guns in sections, rather than casting a single piece. New facilities were constructed to contain the new processes. Between 1888 and 1892, the Ordnance Department constructed a large two-story, brick seacoast gun factory. It was constructed in sections and organized with a center section flanked by two wings; it contained a shrinkage pit, boiler-house, engine-room, and lathes, bores and other machinery employed in the process of "built-up" gun construction. The building was ornamented with large segmentally-arched windows and a corbelled cornice.⁴

The Army constructed other industrial complexes during the early twentieth century. Picatinny, a storage depot in New Jersey, was converted into an arsenal to produce smokeless powder in 1907. Its original production buildings resembled typical, masonry nineteenth-century industrial buildings. They are symmetrical, rectangular, one- and two-story, gable-roofed, brick buildings with regular fenestration.

World War I was a turning point in the evolution of industrial architecture. After World War I, industrial buildings were constructed of steel frame or reinforced concrete and displayed extreme functionalism. The exterior ornamentation often found on nineteenth and early twentieth century industrial buildings was no longer a design element. The materials and design of post-World War I industrial buildings was determined by the production process inside the building. Concrete frame with concrete or clay tile infill was used for buildings with heavy machinery or that contained explosive materials, while steel frame construction often was used when large, open, high spaces were required.

³ Building Technology Incorporated, *Historic Properties Report: Rock Island Arsenal, Rock Island, Illinois, MSS*, Rock Island Arsenal, Rock Island, Illinois, 1985, 26-27.

⁴ *Ibid*, 38-46.

After World War I, production technology at industrial complexes became more complicated. Edgewood Arsenal, Maryland, was constructed during World War I as the Army's first chemical weapons manufacturing plant. The deadly nature of the chemicals required specially designed production techniques that could not be adapted to existing building stock. The chemical weapons production facilities at Edgewood were housed in unadorned, one or one-and one-half story, structural clay tile buildings with industrial sash windows. Structural clay tile became a common construction material for industrial facilities due to its durability, availability, and low cost. Picatinny Arsenal was expanded after World War I. Like Edgewood, it featured specialized production buildings constructed of structural clay tile. These buildings were arranged in a logical sequence to facilitate the production lines.

Industrial Storage Facilities. Storage facilities were prominent and essential components of manufacturing complexes. Storage facilities housed raw materials needed for the production process, products in various stages of production, and the finished products before their shipment to final destinations. Industrial storage facilities generally were built specifically for the installation where they were located; standardization of industrial storage facilities was rare. At some installations, such as Rock Island Arsenal, the Ordnance Department designed and constructed storehouses as major buildings in the manufacturing complex; the similarity in design and materials made the nineteenth-century storehouses nearly identical in exterior appearance to the actual production facilities.

Special warehouses and storage facilities were developed at manufacturing facilities such as Picatinny and Edgewood Arsenal. Both installations were involved in highly technical and specific processes: at Picatinny Arsenal, the production of smokeless powder; at Edgewood Arsenal, chemical weapons. The volatility of the raw materials and final products mandated storage facilities that were of fireproof construction that would contain explosions.

Association:

Military manufacturing complexes are associated with the technological and industrial development of the military and of civilian industry. Manufacturing complexes produced needed supplies and equipment to support various military missions. The kind of manufacturing processes and the types of buildings constructed at a specific site are related directly to the purpose of the facility and the time period of its operation. Military manufacturing complexes also are related to the broader historic context of industrial history.

Industrial complexes rarely were planned and constructed during a single time period. Most industrial facilities evolved over time and reflect subsequent technological improvements, both in production and construction technologies. Original buildings often have been modified, while at the same time new buildings have been added. An important factor in assessing the historic significance of properties associated with a military manufacturing complex is the degree to which the facility represents the manufacturing process, which often was housed in several buildings that formed an interrelated complex. In some cases, individual buildings may possess significance because of architectural merit, but industrial buildings often will contribute to an historic district because of their relationship to the entire complex.

Integrity:

Most industrial buildings have been modified to keep them as vital elements in a production facility. In some cases, new technology is introduced into existing buildings, while in other cases, buildings are modified radically through additions or alterations. The nature of evolving technology required the constant modernization of production facilities. The first step in assessing integrity is to define the significance of the property. If the property is significant for a particular manufacturing process at a certain point in time, then the elements of that process, including buildings and structures and their relationship to one another in the process, should retain sufficient integrity to convey the nature of the industrial process as it appeared during the period of significance. If the property is important as a representative of an industrial process that evolved over time, then subsequent modifications to the property may have acquired their own significance and do not necessarily diminish the property's integrity. In cases where the property possesses architectural significance, then the integrity of the buildings' design, materials, and workmanship assumes primary importance over the industrial process housed in the buildings.

To possess integrity, industrial buildings should retain most of the elements of design, materials, workmanship, and location from their periods of significance. Where subsequent additions, or modifications have occurred, the property still may have integrity if it retains the majority of the features that illustrate its design and industrial process in terms of massing, spatial relationships, pattern of windows and doors, materials, and ornament.

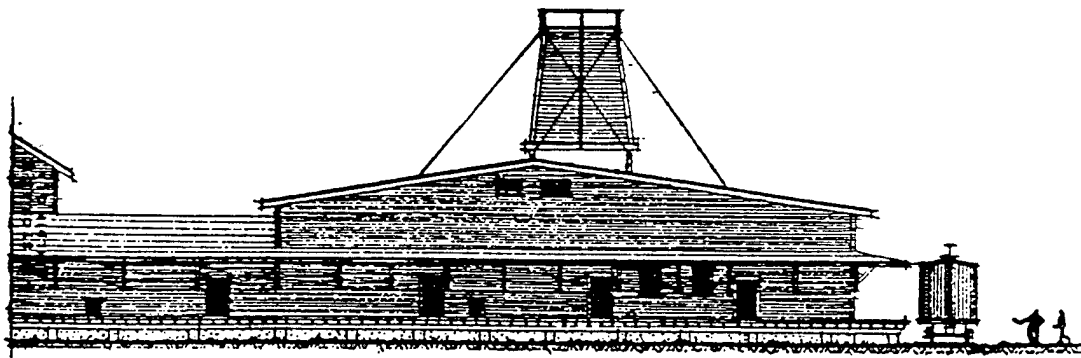

END ELEVATION

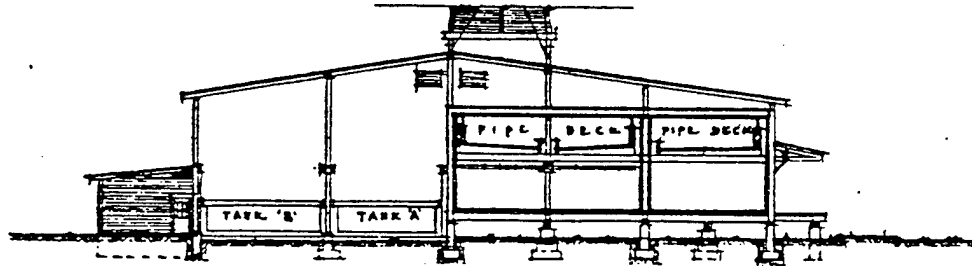

CROSS SECTION

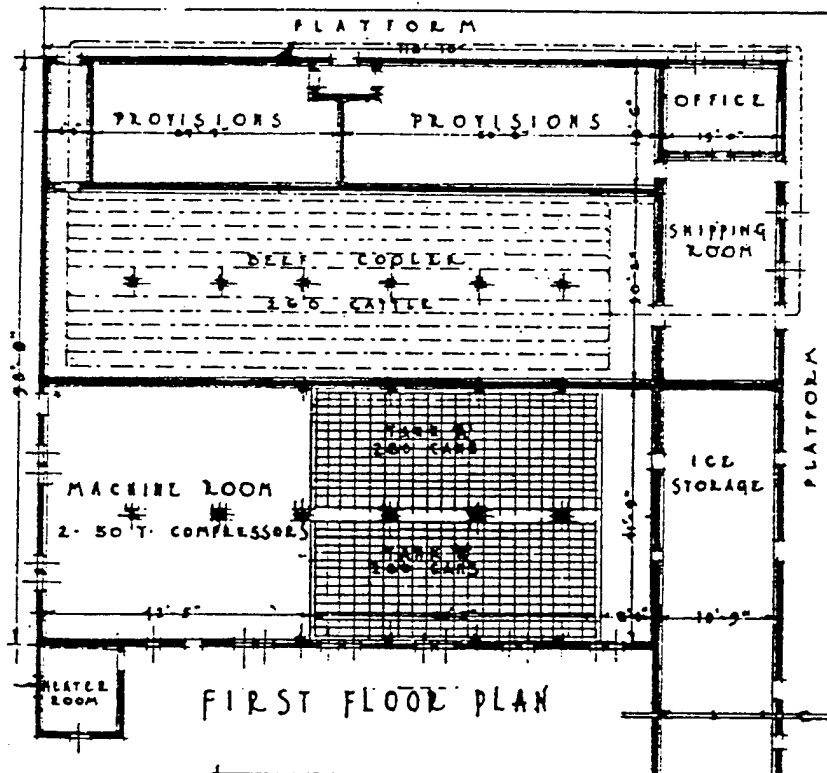

FIRST FLOOR PLAN

ICE STORAGE BLDG.
SHEET # 673-1193
SHEETS 673-1194-1195

0 5 10 20 30
Scale in feet.

CONSTRUCTION DIVISION OF THE ARMY
REFRIGERATING & ICE MAKING PLANT
TYPE "M" SB-28

Category: INDUSTRIAL

Type 5 c-1: Service Facilities: Bakeries

Description:

The bakery was the central facility for large-scale bread production for installation personnel. It generally was a one-story, masonry building with large chimneys or vents for baking ovens. The size of installation bakeries depended on the size of the installations they served. In some cases, bakeries were combined with mess halls or other uses. Bakeries generally were utilitarian structures with little exterior ornament.

Evolution:

The construction of free-standing bakeries on Army posts during the late nineteenth century was the result of efforts to consolidate food preparation at Army installations. During most of the nineteenth century, mess, or eating facilities, were provided in the barracks. Bread baking was a daily task that required constant attention. The Army determined that a separate post bakery would free mess rooms for other uses and provide larger amounts of bread more cost effectively.

The Quartermaster Department first issued a standardized plan for a bakery in 1872. The plan depicts a one-story, rectangular building with ovens and a store room along one wall, and the remainder of the interior open. By the end of the nineteenth century, bakeries were standard components of Army posts and had increased in size to meet the needs of larger garrisons. Army regulations placed the bakery under the supervision of the post treasurer; the Quartermaster Department was charged with the responsibility of providing the building and equipment for the post bakery.⁵

Between 1891 and 1906, the Quartermaster Department designed the bakery to include more rooms, such as a bedroom for the cooks, proof room, boiler room, fuel room, and lavatory, as well as specialized rooms for mixing, rising, and baking bread. Ventilation was always a concern. In 1892, the Quartermaster Department issued a plan for a bakery with a monitor roof. By 1898, standardized plans depicted metal vents in the roof.⁶

The Army continued to construct separate bakeries throughout the 1930s. They were often located in the Quartermaster Department warehouse use and support area of the installation. By the 1930s, bakeries typically were constructed of masonry on concrete foundations, and were capped by shallow gable roofs with metal vents and parapet gable ends. Often the building reflected the prevailing architectural vocabulary, such as Georgian Colonial Revival, of the installation, though with simplified, scaled-back detailing.

⁵ War Department, General Staff, *Manual for the Quartermaster's Department*, United States Army, 1904, Washington, D.C.- Government Printing Office, 1904, 29.

⁶ War Department, *Annual Report*, 1872, plate 1 0; NARA, Cartographic Branch, RG 77, Standard Plans of Army Post Buildings, 1891-1918, Plans 49A-R, 217, 218.

Association:

Bakeries are associated with the increasing diversity of functions on military installations during the late nineteenth and early twentieth centuries as they grew in size and in the number of services the military provided to installation personnel. Bakeries are secondary, support facilities of utilitarian design located in the storage and support area of installations. They may contribute to an historic district, but rarely possess sufficient significance to merit listing in the National Register as individual buildings.

Integrity:

To possess integrity, bakeries should retain most of their design, materials, association, location, and workmanship to reflect the periods of significance of the historic district. In general, bakeries no longer function as such and have been modified heavily for new uses, usually maintenance buildings. Common modifications include alterations of original window and door openings. The building still may possess integrity if it retains the majority of its original features, including the overall shape of the building and roof, exterior materials, chimney, roof vents, and patterns of door and window openings.

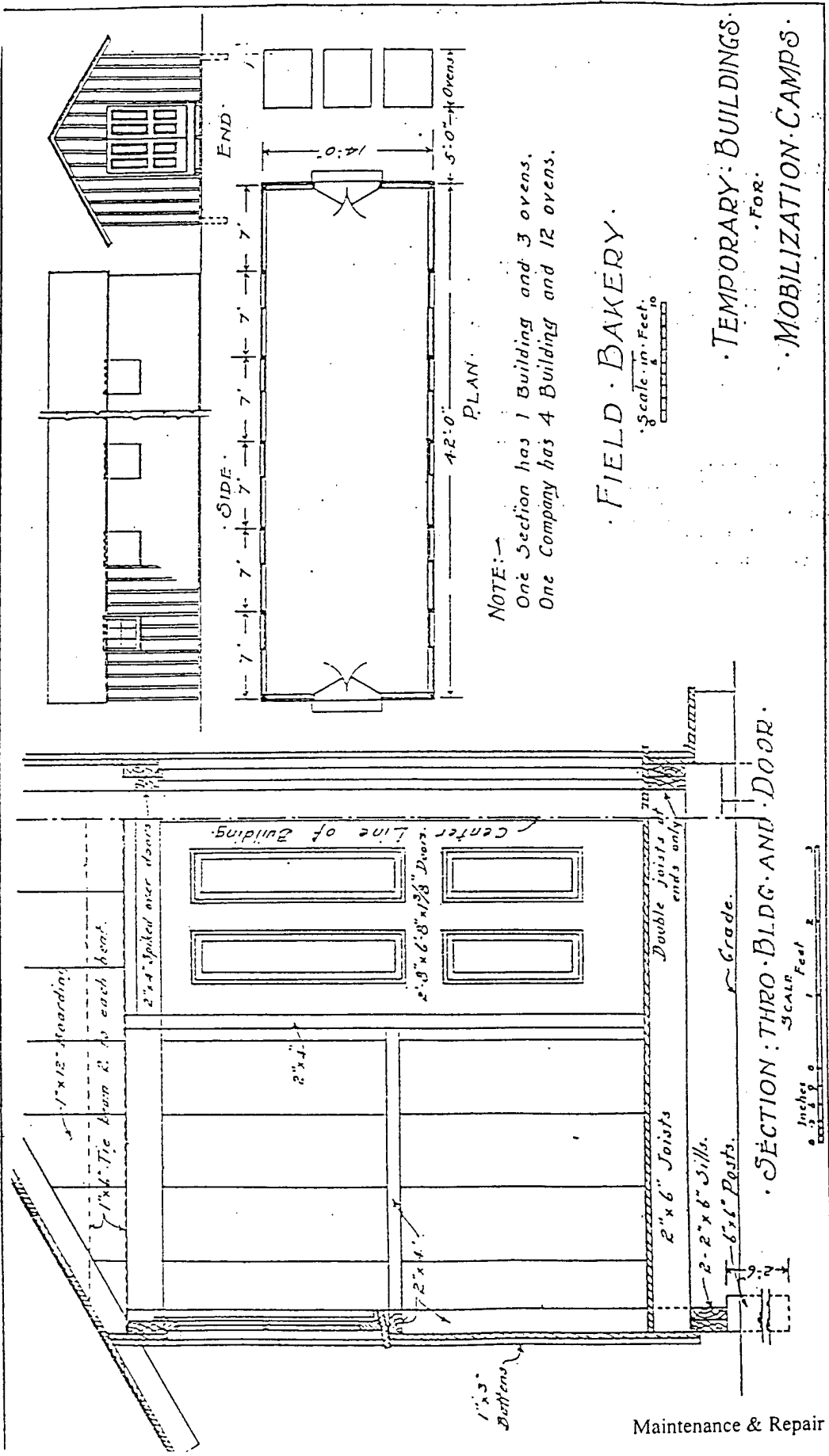

NOTE:—
 One Section has 1 Building and 3 ovens.
 One Company has 4 Building and 12 ovens.

FIELD BAKERY.

Scale: 1/4" = 1'-0"

TEMPORARY BUILDINGS.
 FOR.
 MOBILIZATION CAMPS.

SECTION: THRO BLDG AND DOOR.

Scale: 1/4" = 1'-0"

APPENDIX No. 10-16.

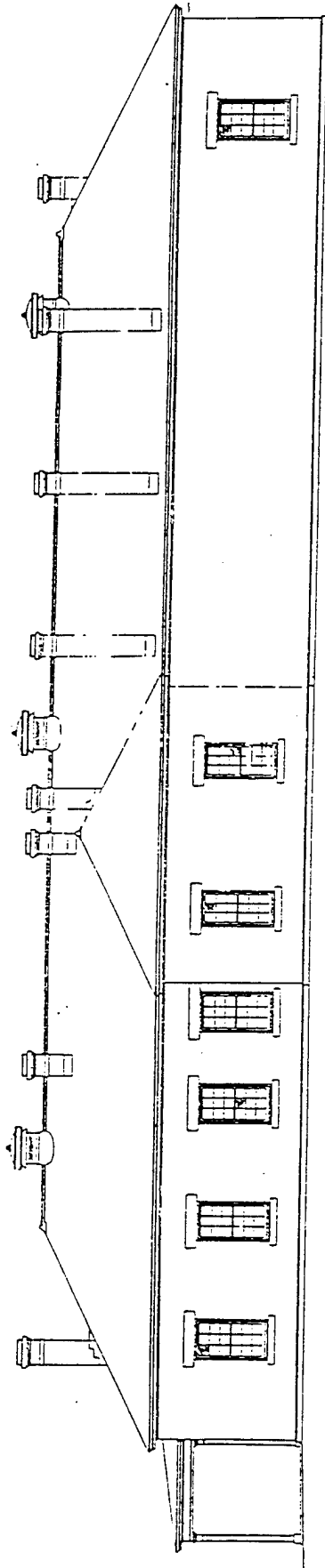

REAR ELEVATION
SCALE 1/4" = 1'-0"

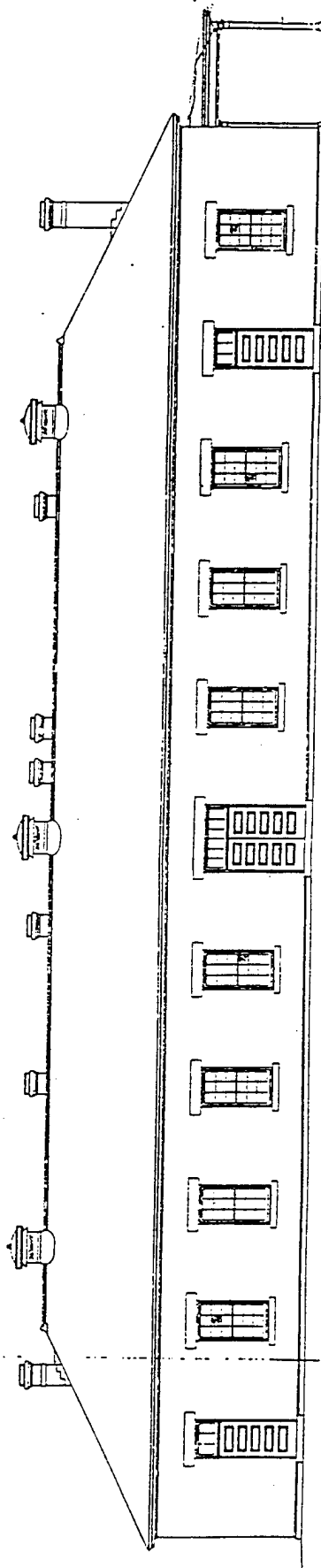

FRONT ELEVATION
SCALE 1/4" = 1'-0"

 WRIGHT & WRIGHT ARCHITECTS
 BAKERY
 OMAHA NE MAY 1902

Category: INDUSTRIAL

Type 5 c-2: Service Facilities: Laundries

Description:

Laundries were utilitarian, one-story structures that served as the central laundry facility for an installation. Surviving examples of laundries are of masonry construction. Laundries generally were located in the support area of an installation.

Evolution:

At Army posts during the nineteenth century, laundresses washed the troops' laundry by hand. Laundry was washed in various places at different posts. Laundresses often would wash clothes outdoors at a nearby body of water. At some installations, such as Ft. Sill, Oklahoma, "wash houses" were located behind each barracks and behind the hospital near the laundress' quarters. Some early barracks included a wash room. Most frontier posts included quarters for laundresses at the edges of the post.

During the 1890s, separate quarters for laundresses began to disappear. The Quartermaster Department began to issue plans for officers' quarters that included a laundry and servant's quarters. During the early 1890s, barracks still were designed to include wash rooms, but, by 1894, wash rooms no longer appeared in barracks plans.⁷

The Quartermaster Department issued standardized plans for consolidated laundry facilities between 1908 and 1915. The plans depict a one-story building with a large boiler room. The building included the laundry, a sorting room, and an office. A variation on this plan was a two-story building with a one-story boiler room attached. In 1915, a standard laundry plan depicted a building two stories in height that contained a single tall interior space, with a one-story boiler room attached.⁸

Laundry facilities continued to grow in size to match the increasing size of installations. During the wave of new construction during the late 1920s and the 1930s, newly constructed laundries were large rectangular buildings with a gabled parapet roof. Dry cleaning facilities begin to appear during the late 1930s and 1940s.

Association:

⁷ NARA, Cartographic Branch, RG 77, Standard Plans of Army Post Buildings, 1891 - 1918, Officers' Housing; David A. Clary, *A Life Which is Gregarious in the Extreme: A History of Furniture in Barracks, Hospitals, and Guardhouses of the United States Army, 1880-1945*, MSS, U.S. Department of the Interior, National Park Service, Harpers Ferry Center, Harpers Ferry, West Virginia, 1983, 134; David A. Clary, *These Relics of Barbarism: A History of Furniture in Barracks and Guardhouses of the United States Army, 1800-1880*, MSS, U.S. Department of the Interior, National Park Service, Harpers Ferry Center, Harpers Ferry, West Virginia, 1983, 115, 346.

⁸ NARA, Cartographic Branch, RG 77, Standard Plans of Army Posts, 1891 - 1918, Plan 234, 234A, 234-B, 402.

Laundries are associated with the increased complexity of military installations after the end of the nineteenth century and the growing number of services that were provided for installation personnel. Large centralized laundry facilities were constructed to house institutional-sized laundry equipment and replaced small wash houses and hand washing by non-military personnel. Laundries are one of many service buildings that were secondary support facilities at military installations. Laundries rarely possess historical significance as individual buildings; however, a laundry may be a contributing building in an historic district.

Integrity:

Laundries are utilitarian buildings, usually located in the support areas of an installation. To possess integrity, laundries should retain most of the elements of their design, materials, workmanship, setting, and location. Laundry buildings usually no longer function as laundries and have been modified extensively for new uses, often maintenance buildings or commissaries. Elements that generally have been modified include original window and door openings. Where subsequent additions or renovations have occurred, the building may have integrity if it retains the majority of its massing, shape, pattern of openings, materials, and ornament.

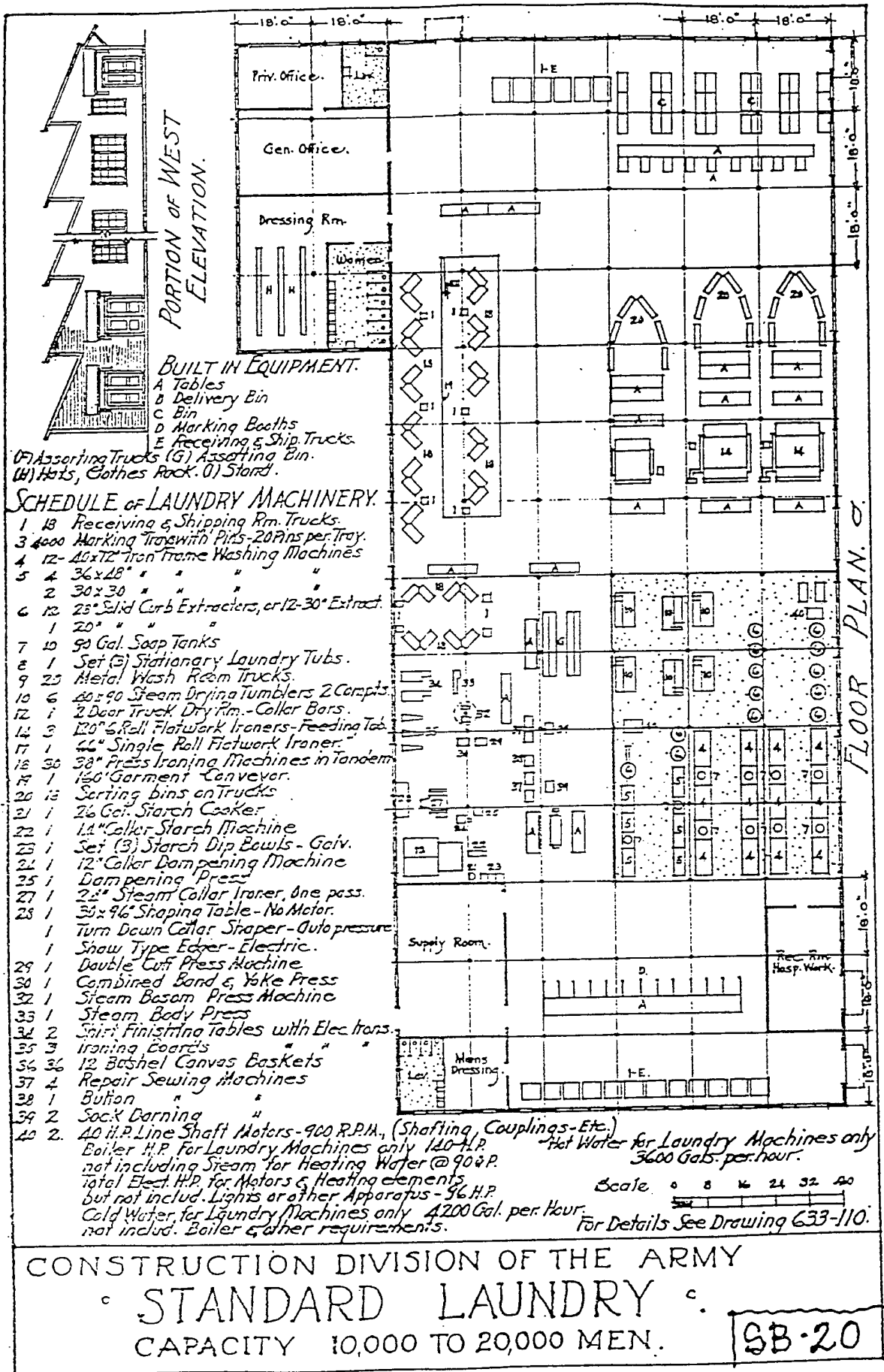

BUILT IN EQUIPMENT.
 A Tables
 B Delivery Bin
 C Bin
 D Marking Booths
 E Receiving & Ship. Trucks
 (F) Assorting Trucks (G) Assorting Bin.
 (H) Hats, (I) Clothes Rack, (J) Stands.

SCHEDULE OF LAUNDRY MACHINERY.

- 1 18 Receiving & Shipping Rm. Trucks.
- 3 4000 Marking Trays with Pins - 20 Pins per Tray.
- 4 12-46x72" Iron Frame Washing Machines
- 5 4 36x48" " " " "
- 2 30x30 " " " "
- 6 12 28" Solid Curb Extracters, or 12-30" Extract.
- 1 20" " " " "
- 7 10 90 Gal. Soap Tanks
- 8 1 Set (5) Stationary Laundry Tubs.
- 9 25 Metal Wash Room Trucks.
- 10 6 60x90 Steam Drying Tumblers 2 Compts.
- 12 1 2-Door Truck Dry Rm. - Collar Bars.
- 14 3 120" Roll Flatwork Ironers - Feeding Tab.
- 17 1 66" Single Roll Flatwork Ironer.
- 18 30 38" Press Machines in Tandem
- 19 1 150' Garment Conveyor.
- 20 12 Sorting bins on Trucks
- 21 1 26 Gal. Starch Cooker
- 22 1 14" Collar Starch Machine
- 23 1 Set (3) Starch Dip Bowls - Galv.
- 24 1 12" Collar Dampening Machine
- 25 1 Dampening Press
- 27 1 24" Steam Collar Ironer, One pass.
- 28 1 36x96" Shaping Table - No Motor.
- 1 Turn Down Collar Stripper - Auto pressure.
- 1 Snow Type Edger - Electric.
- 29 1 Double Cuff Press Machine
- 30 1 Combined Band & Yoke Press
- 32 1 Steam Basom Press Machine
- 33 1 Steam Body Press
- 34 2 Smit. Finishing Tables with Elec. Irons.
- 35 3 Ironing Boards
- 36 36 12 Bushel Canvas Baskets
- 37 4 Repair Sewing Machines
- 38 1 Button
- 39 2 Sock Darning
- 40 2 40 H.P. Line Shaft Motors - 900 R.P.M., (Shafting, Couplings - Etc.)

Boiler H.P. For Laundry Machines only 120 H.P.
 not including Steam for Heating Water @ 90° P.
 Total Elect. H.P. For Motors & Heating Elements
 but not includ. Lights or other Apparatus - 96 H.P.
 Cold Water for Laundry Machines only 4200 Gal. per Hour.
 not includ. Boiler & other requirements.

Hot Water for Laundry Machines only
 3600 Gals. per hour.

Scale 0 8 16 24 32 40
 For Details See Drawing 633-110.

CONSTRUCTION DIVISION OF THE ARMY
 ° STANDARD LAUNDRY °
 CAPACITY 10,000 TO 20,000 MEN. **SB-20**

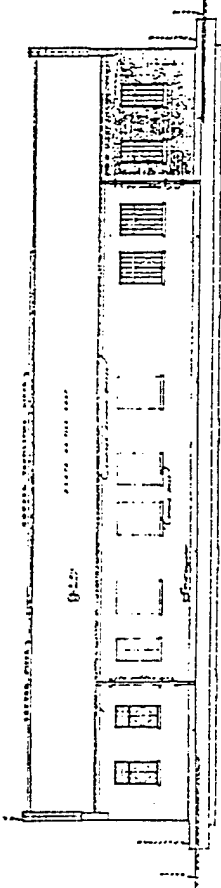

FRONT ELEVATION.

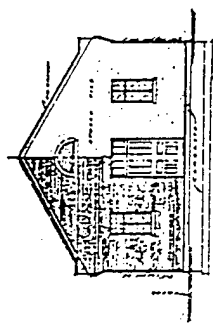

END ELEVATION.

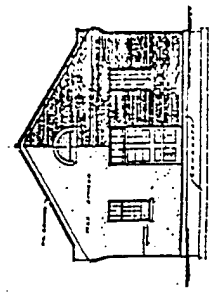

END ELEVATION.

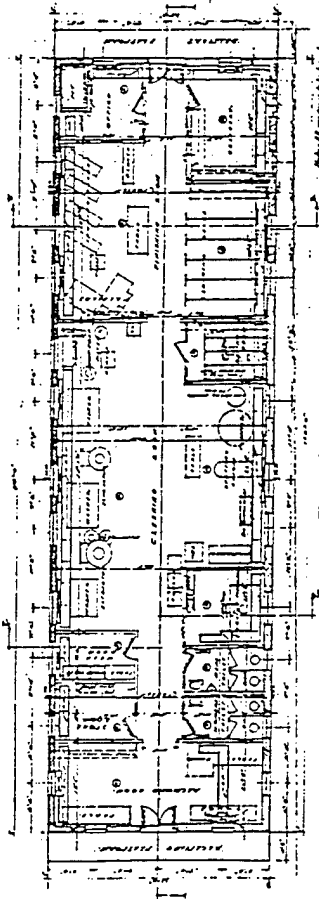

FLOOR-PLAN.

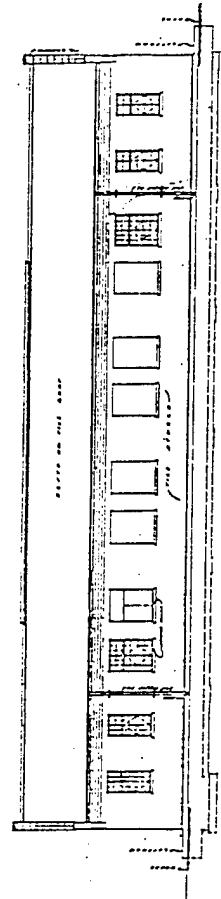

REAR ELEVATION.

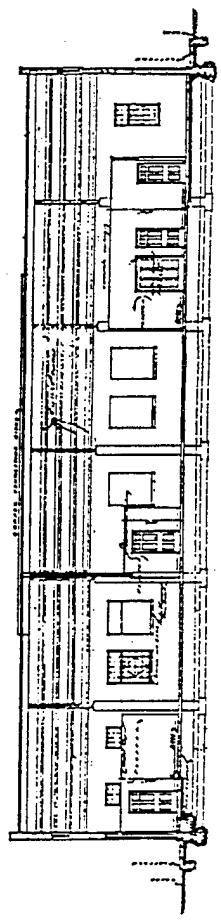

SECTION OF LINE 'A-X'.

- LEGEND
- Checkers
 - Windows
 - Doors
 - Stairs
 - Elevation of this building
 - Elevation of other building
 - Foundation
 - Foundation
 - Foundation

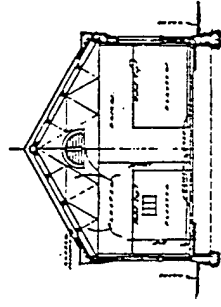

SECTION OF LINE 'B-Y'.

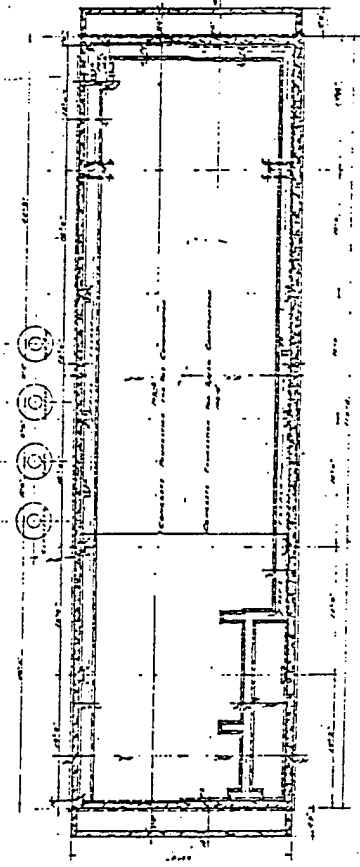

BASMENT PLAN.

SCALE: 1/4" = 1'-0"

CONSTRUCTION SERVICE
OFFICE OF THE QUARTERMASTER GENERAL

FOR: OKLA., OKLA.

TYPICAL DRY CLEANING PLANT

NO. 14, 611

633-165

Category: INDUSTRIAL

Type 5 d-1: Storage: General Storage

Description:

Storage facilities were constructed to store needed supplies. The military distributed supplies from central depots to individual installations. This resulted in two large groups of storage facilities complexes of storage buildings at supply depots that served regions, and warehouses to store the supplies needed at specific installations. Typical supplies included subsistence, clothing, raw materials, equipment, and other general supplies. Storage facilities were generally utilitarian buildings constructed of a variety of materials, including wood, stone, brick, structural clay tile, or corrugated metal. Storage buildings usually were one- or two-story, long rectangular buildings with pitched roofs, regular openings, and little ornament. In cases where installations were planned and constructed at one time, the military generally constructed storage facilities that reflected the overall architectural character of the installation. Ordnance storage is discussed in the next section; storage associated with manufacturing complexes is discussed in a previous section.

Evolution:

Installation storage. During the nineteenth century, the Subsistence Department and the Quartermaster Department were the two primary users of storage facilities. The Subsistence Department provided basic food rations; the Quartermaster Department issued clothing and equipment to men and provided fodder for animals. The Quartermaster Department proposed standardized plans for a general storehouse in 1860 and for a commissary store house in 1872. Both proposed plans showed one-story buildings with large open interior spaces.⁹ Little differentiation between the two buildings is apparent, suggesting that the same building easily could be used by either department. Storehouses or warehouses were located in an area separate from the main cantonment. The typical warehouse was a one- or two-story rectangular building with a pitched roof and regular openings, often with bars over the windows for security.

In 1866, Congress authorized the Army to sell food from the government stocks to officers, enlisted men, and their dependents. Although the Army initially limited sales to those items already purchased for issue to soldiers, eventually soldiers and their families were allowed to special order other items. Later, the post commissary warehouse began to stock items specifically for retail trade. The Quartermaster Department designed a commissary warehouse plan with a separate retail counter. This sales counter was the birth of the modern day commissary. The commissary warehouses were similar to other warehouses in the post warehouse area.¹⁰

⁹ War Department, *Regulations Concerning Barracks and Quarters for the Army of the United States, 1860*, Washington, D.C. George W. Bowman, 1861; War Department, *Annual Reports of the Quartermaster-General*, Washington, D.C. Government Printing Office, 1872.

¹⁰ Michael E. Hucles, *From Haversack to Checkout Counter. A Brief History of the Army Commissary System*, Fort Lee, Virginia: U.S. Army Troop Support Agency, 1991, 54.

During the nineteenth century, usually one or two storehouses fulfilled the needs of individual Army posts. As the Army consolidated its troops into larger, more permanent installations during the 1880s and 1890s, support facilities also were expanded. The Army continued to place the utilitarian functions of the Quartermaster and Subsistence Departments in a separate area from the main parade ground and cantonment. The utilitarian functions needed to operate the post formed a complex of storage, transportation support, and repair and maintenance facilities. For example, wagon trains originally transported supplies to Army posts. The Quartermaster Department's complex contained housing for teamsters, fodder for draft animals, and a blacksmith shop. During the last quarter of the nineteenth century, the railroad supplanted the wagon train as the primary means of transportation and the Quartermaster complex was linked directly to railroad lines.

In 1892, the Quartermaster Department issued standardized plans for a combined Quartermaster and Commissary storehouse. When the Quartermaster and Subsistence Departments shared a warehouse, the interior was divided down the middle; each end of the building had its own set of offices and issue counters. Generally, the building had a loading platform along one long side of the building. This basic Quartermaster warehouse design remained the same from 1892 until the end of the 1930s. The only major change was that the building grew from one-and-a-half stories to two stories with attic.¹¹

During the twentieth century, there was a dramatic increase in the number of storage facilities required to store the supplies of a modern army. During World War I, the Army established larger warehouse districts at its training camps. Warehouse districts comprised rows of one-story, temporary wooden storehouses located along railroad sidings. After the war ended, the increasingly mechanized Army continued to require more storage facilities to store unused materiel returned from the war front. For example, eleven flat-roofed storage buildings were constructed at Rock Island Arsenal, Illinois, between 1919 and 1921, for storage of artillery vehicles and equipment. To meet the post-war storage needs, the Army sheathed some World War I temporary frame warehouses structural with clay tile or brick.

During the 1930s, some individual Army installations continued to require large warehouse districts, particularly posts with large numbers of soldiers, such as Forts Knob, Benign, Bliss, and Sill. Warehouse districts comprised rows of utilitarian, one-story buildings separated by projecting brick fire walls.

Storage facilities constructed at Army Air Corps installations sometimes did not follow the same design and site patterns as the Quartermaster Department warehouses on other Army posts. Army Air Corps storage facilities were similar in design to the hangars and the maintenance and repair shops built at the same time at airfields. Airfield storage facilities were located near the flight line with the maintenance and repair shops and airplane hangars, rather than in a separate warehouse district. The typical storage buildings were one-story, rectangular, masonry buildings

¹¹ NARA, Cartographic Branch, RG 77, Standard Plans of Army Post Buildings, 1891-1918, Plans, 43, 63, 78, 86, 106, 278.

with gable roofs and industrial sash windows. They generally shared the same architectural character and motifs as the surrounding buildings of the flight line area.

When special storage facilities were required at a post, the Quartermaster Department often issued separate plans, designed according to the type and size of materiel requiring storage and the department requesting storage facilities. After the Army first issued oil lamps to troops, the Quartermaster Department built oil houses to store oil. During the first decade of the twentieth century, the Quartermaster Department issued separate plans for buildings to store special engineering, signal, and photographic equipment and supplies. These specialized storage facilities are less common building types not found on every installation.

Depots. In addition to the general storage facilities that were a standard component of every Army post no matter its purpose, the Army operated supply depots to serve as regional storage and distribution centers. After the Civil War, the Quartermaster Department adopted a system of depots to facilitate supplying Army installations. The Quartermaster Department controlled general depots, while department or division commanders controlled regional depots. The spread of railroad lines made the delivery of supplies easier and a central location for assembling supplies more advantageous. By 1869, the Quartermaster Department had four general depots, at New York, Philadelphia, Washington, and Jeffersonville, Indiana.¹²

In 1878, the Quartermaster Department established the San Antonio Depot, now part of Ft. Sam Houston, Texas, as a regional storage facility for the Department of Texas. Supplies were distributed from the depot by rail to other forts in the Southwest. Quartermaster General Montgomery C. Meigs designed the San Antonio depot as a quadrangle with stone storehouses facing an interior courtyard. A tall stone water tower marked the center of the quadrangle.

During the twentieth century, regional storage depots proliferated as the Army developed more complex logistical systems to serve larger number of troops and increased amounts of equipment. This trend was particularly important during World Wars I and II when specialized storage depots were established for specific materials. During World War II, Edgewood Arsenal became the Eastern Chemical Depot, the first and only chemical storage facility on the East Coast. Edgewood required an extensive number of warehouses and storage igloos. Other large storage facilities were constructed at ports of embarkation, such as Ft. Mason in San Francisco, where massive architect-designed warehouses were constructed during World War II.

The Army also developed a system of aviation depots to serve as central distribution points for supplies to individual airfields. One example was the Fairfield Aviation Depot, Ohio, now part of Wright-Patterson AFB. The depot began operation in 1917 and provided logistics support to the four Signal Corps Aviation Schools operating in the Midwest. Other aviation depots included the Engine and Repair Depot, now Maxwell AFB, Alabama, and Sacramento Depot, now McClellan AFB, California. The aviation depots were characterized by rows of utilitarian warehouses.

¹² Erna Risch, *Quartermaster Support of the Army 1775-1939*, Washington, D.C. Government Printing Office, 1962. Reprint 1989, 457.

Association:

Storage buildings are support facilities required to sustain the operations of a military installation. The size, extent, and purposes of storage facilities illustrate the evolution of military logistics, supply, and technology. The construction of the buildings, including architectural ornamentation and siting, reflect the period of construction. These buildings can be minor utilitarian buildings or major architectural elements on an installation. Storage facilities, in general, do not possess individual historic significance, but may be contributing elements to an historic district. They can be secondary facilities that supported the installation's primary mission, whether it was a frontier fort or an airfield, or storage facilities can compose the bulk of the installation. Within various types of installations, the storage facilities may be interspersed with other types of buildings or may form a distinct warehouse district.

Integrity:

To possess integrity, storage facilities should retain most of the design, location, setting, materials, and workmanship from the period of significance of the historic district. Character-defining features of this building type include the building form, original materials, pattern of openings, and relationship with a complex of other storage facilities. An isolated storage building that once was part of a complex is not as good a representative of the building type as an intact complex. Storage facilities often have been modified or altered for other uses. Where a building has undergone subsequent additions or renovations, the building still may have integrity if it retains the majority of its setting, massing, proportion, pattern of windows and doors, materials, and ornamentation.

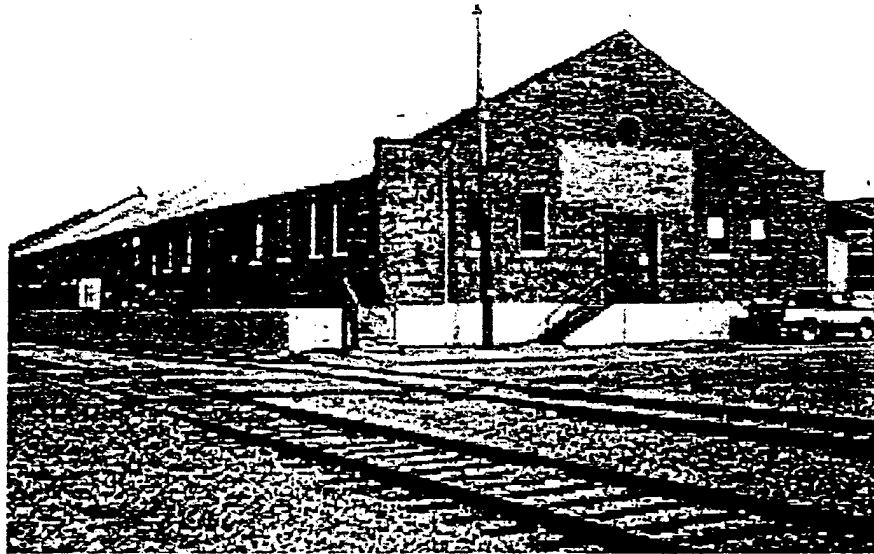

1938 Quartermaster Warehouse at McChord AFB, WA



1905-6 Quartermaster Storehouse at Vancouver Barracks, WA

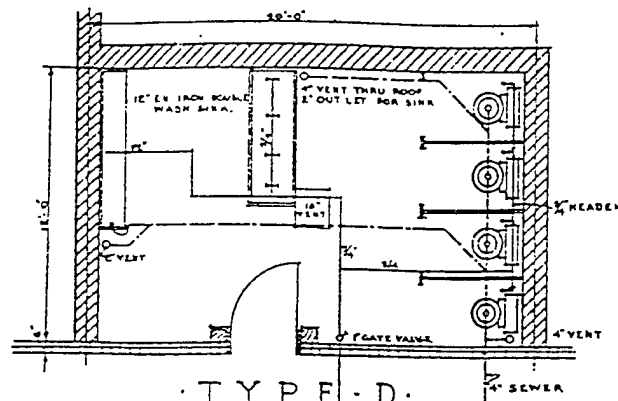

TYPE D

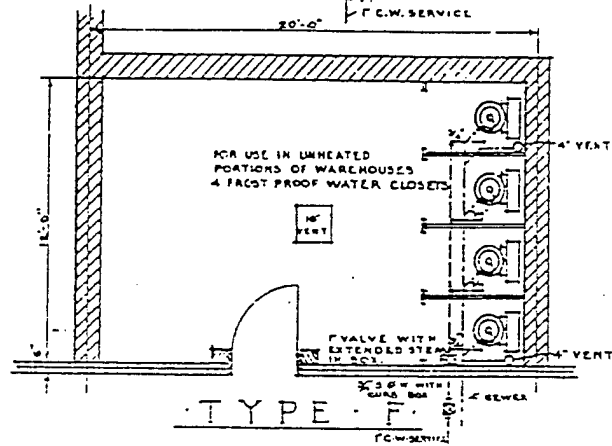

TYPE F

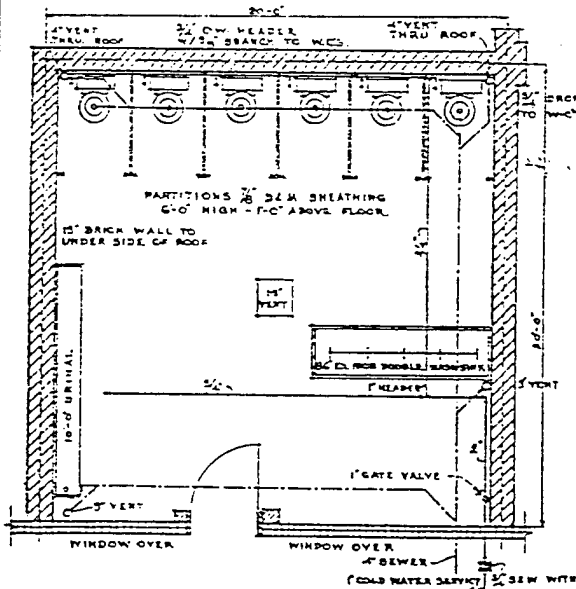

TYPE C

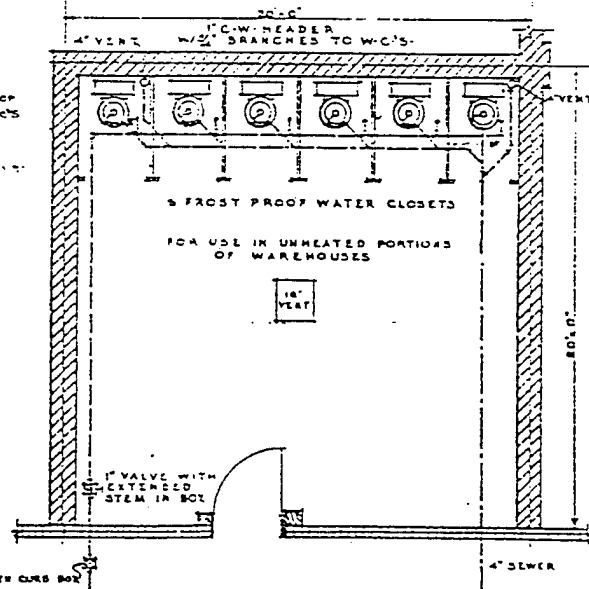

TYPE E

SCALE
 1 2 3 4 5 6 7 8 9 10 FT.

FOR DETAILS SEE DRAWING 672-42

CONSTRUCTION DIVISION OF THE ARMY
 TYPICAL EMERGENCY STORAGE WAREHOUSE
 STANDARD TOILET ROOMS SB-10

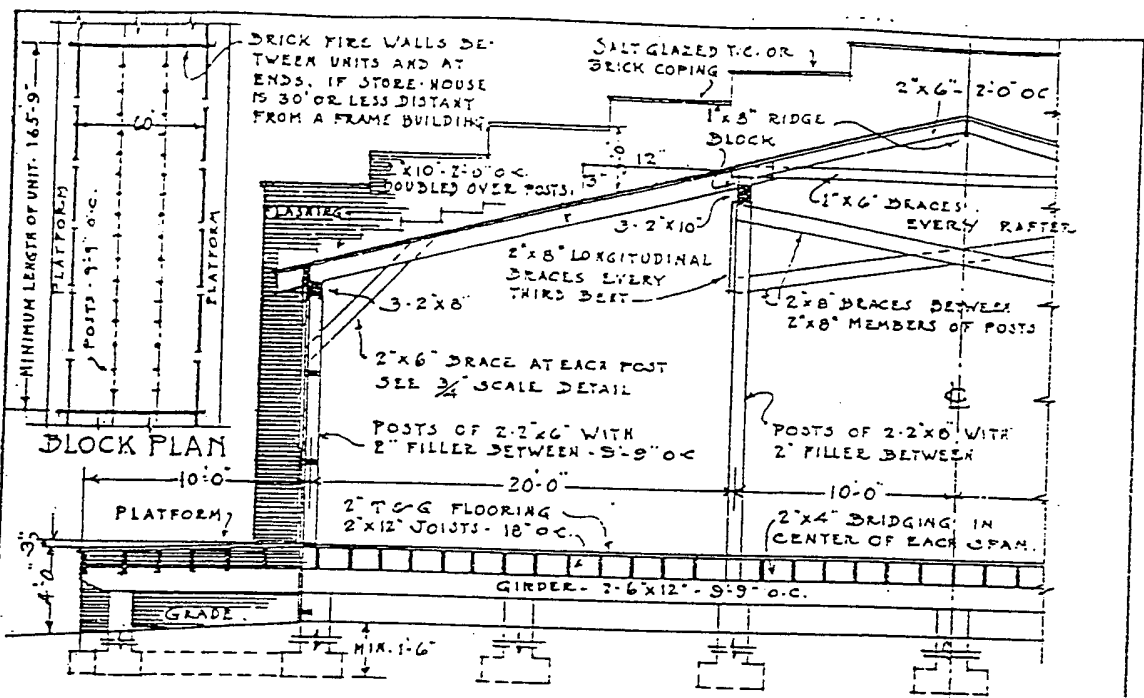

SECTION SCALE 0 1 2 3 4 5 6 7 8 9 10

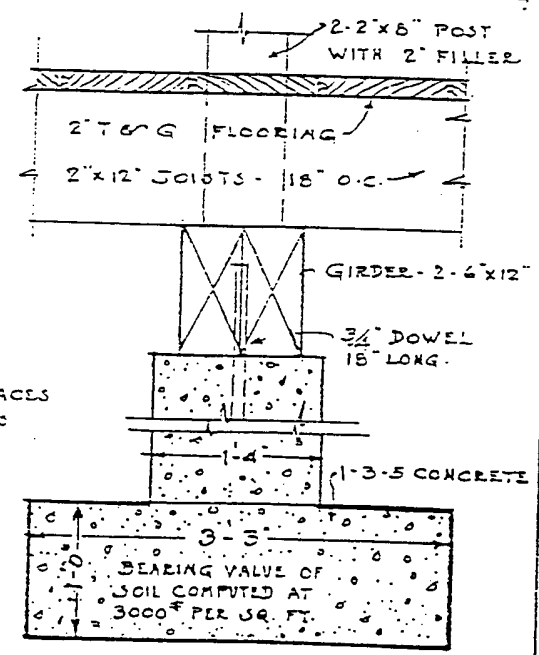
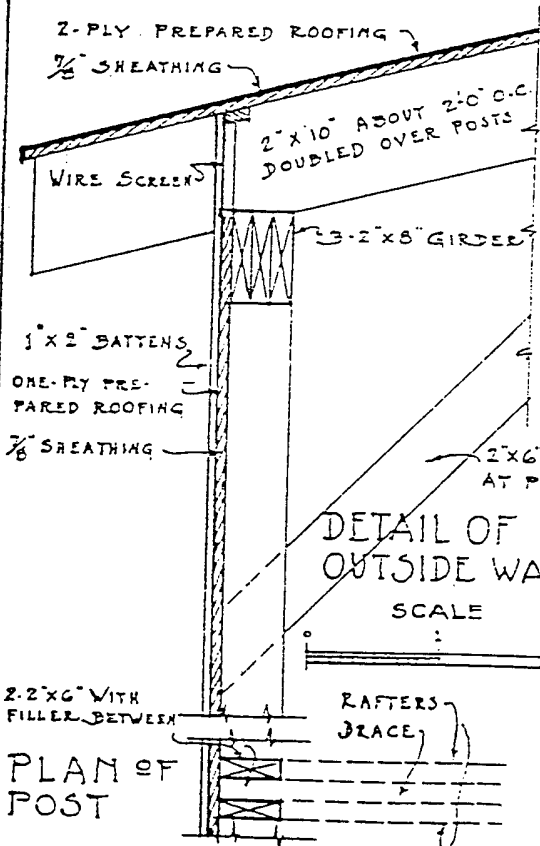

FOR DETAILS SEE DRAWING G20-319

CONSTRUCTION DIVISION OF THE ARMY SB-16
TYPICAL BUILDINGS
 DIVISIONAL STORE HOUSE - NON-INSULATED

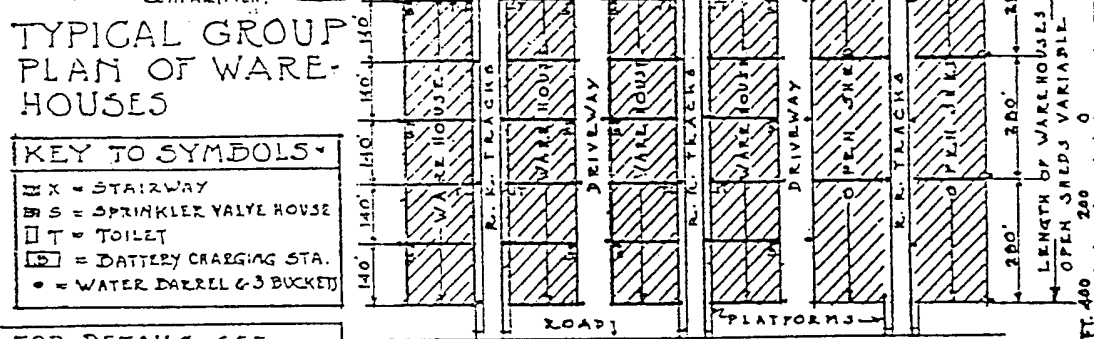
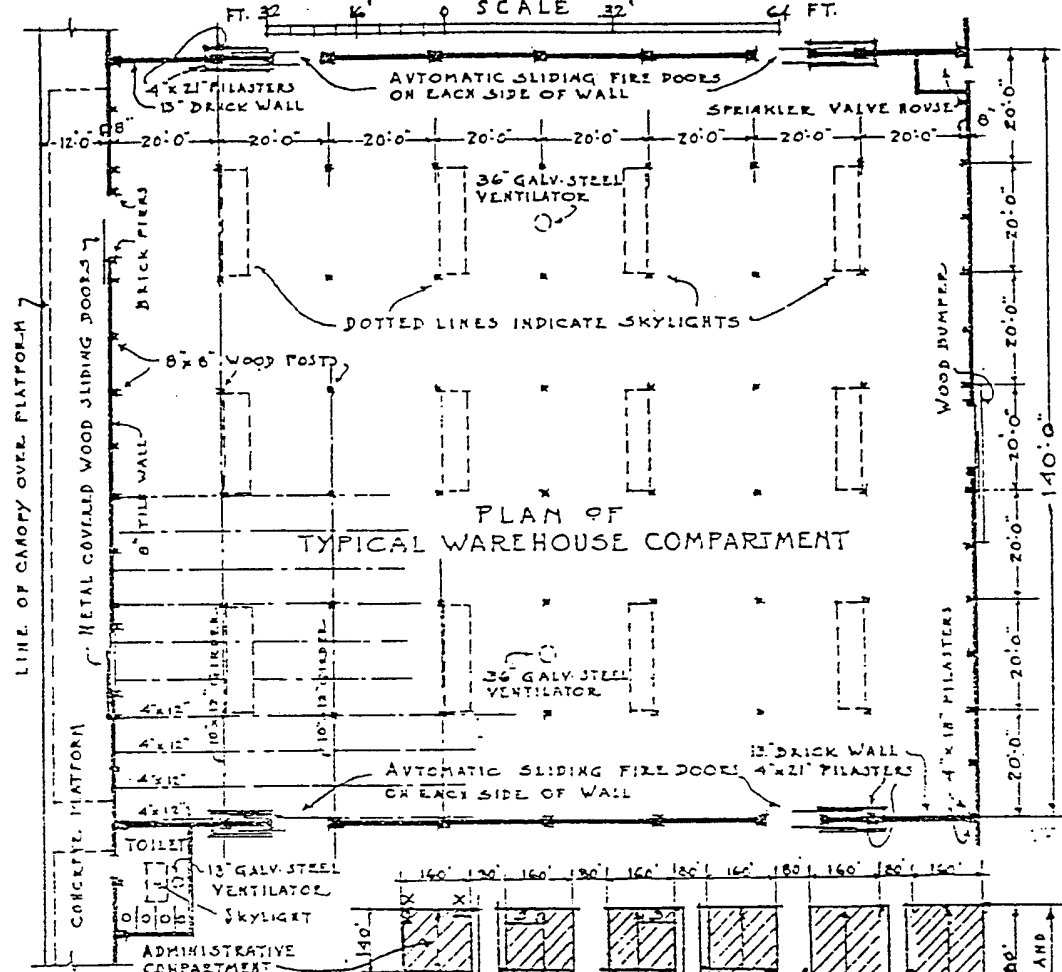
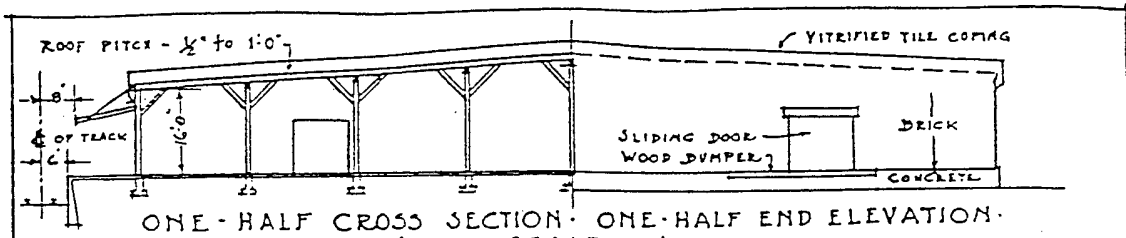

- KEY TO SYMBOLS**
- ✕ = STAIRWAY
 - ⊞ = SPRINKLER VALVE HOUSE
 - ⊞ = TOILET
 - ⊞ = BATTERY CHARGING STA.
 - = WATER BARREL & 3 BUCKETS

FOR DETAILS SEE DRAWINGS 6271-5 & 17

CONSTRUCTION DIVISION OF THE ARMY SB-25
 TYPICAL EMERGENCY STORAGE WAREHOUSE
 TYPICAL COMPARTMENT & GROUP PLAN

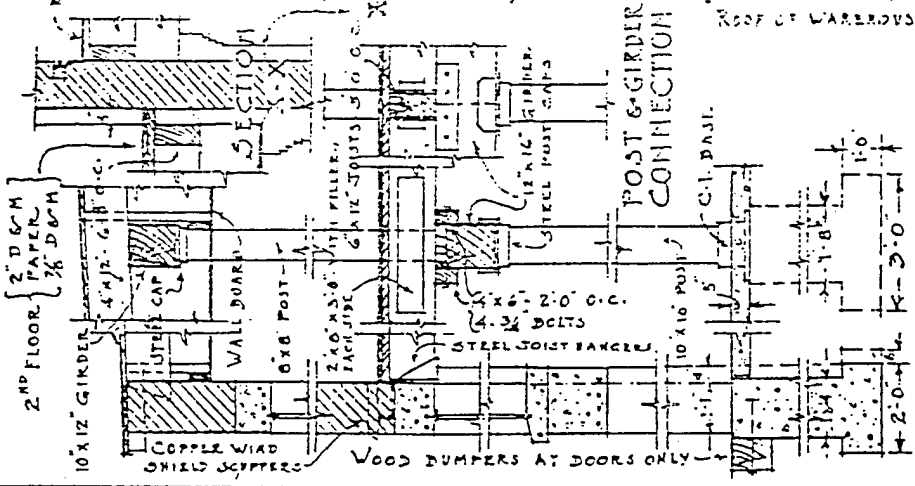
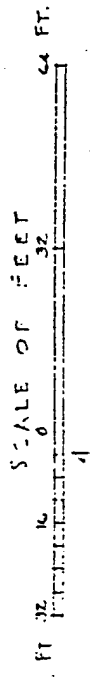
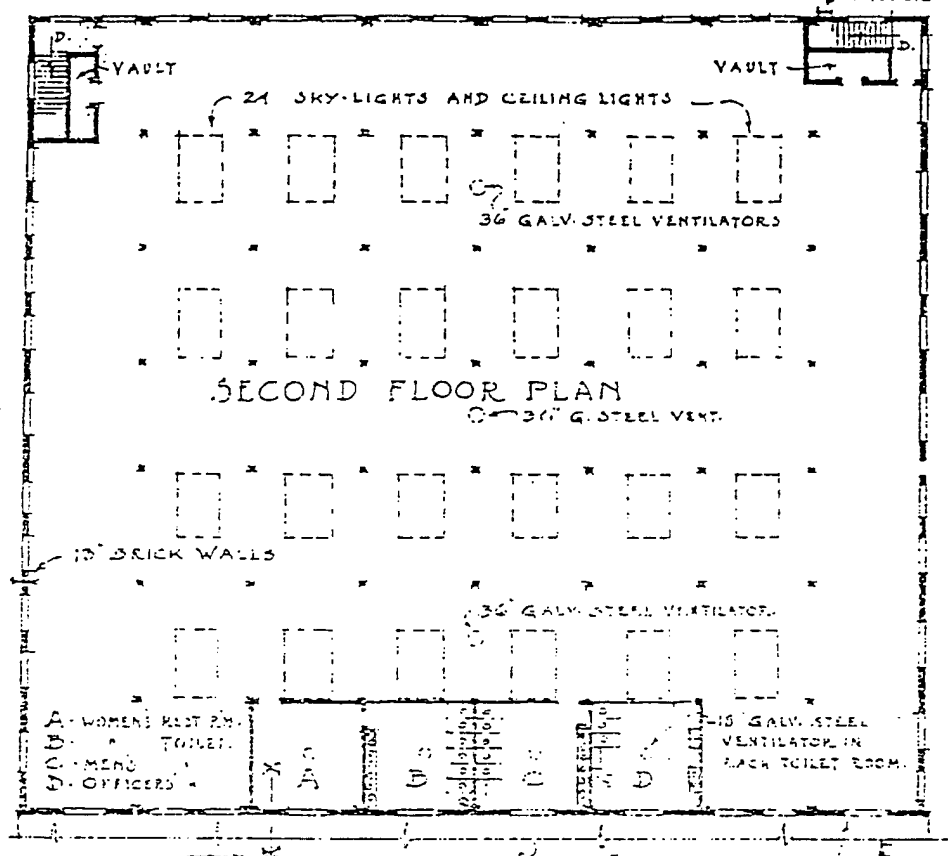
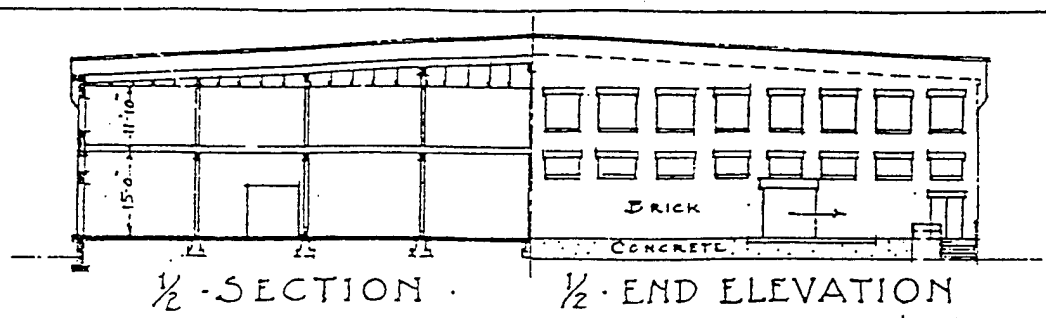

CONSTRUCTION DETAILS

SCALE - FEET

NOTE - FIRST FLOOR PLAN IS SIMILAR TO THAT OF ONE STORY WAREHOUSES - EXCEPT STAIRWAYS AND BRICK INSTEAD OF TILE WALLS.

FOR DETAILS SEE DRAWING NO. 6271-7.

CONSTRUCTION DIVISION OF THE ARMY. **SB-26**

TYPICAL EMERGENCY STORAGE WAREHOUSE

ADMINISTRATION BUILDING.

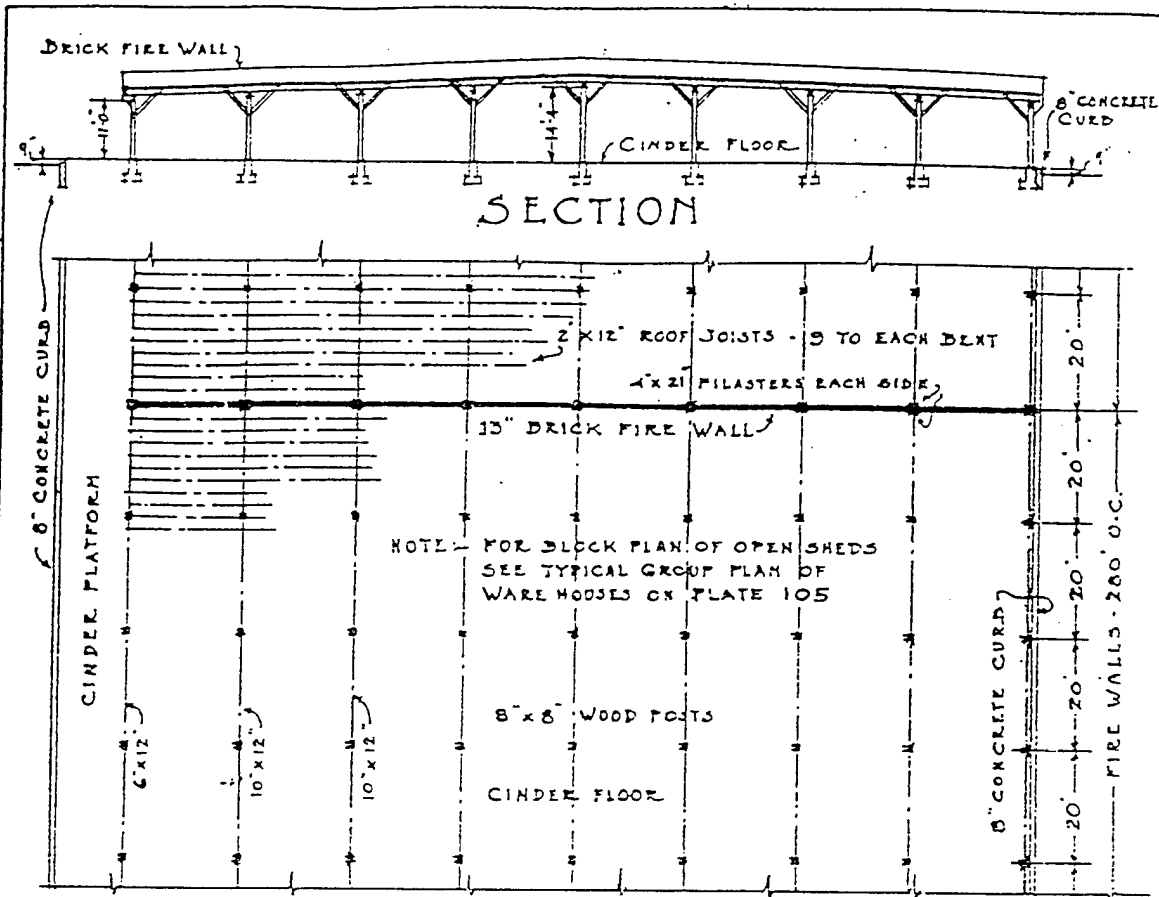

PART PLAN OF OPEN SHED

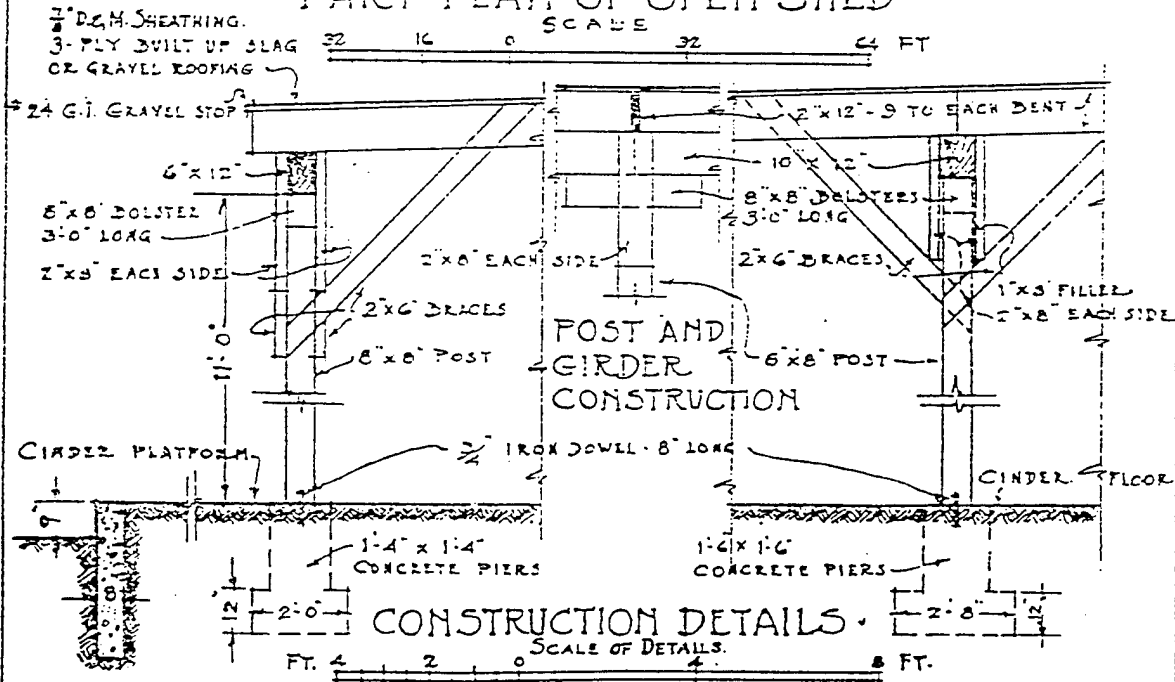

FOR DETAILS SEE DRAWING 6271-12.

CONSTRUCTION DIVISION OF THE ARMY **SB-27**
 TYPICAL EMERGENCY STORAGE WAREHOUSE
 PLAN, SECTION & DETAILS OF OPEN SHED

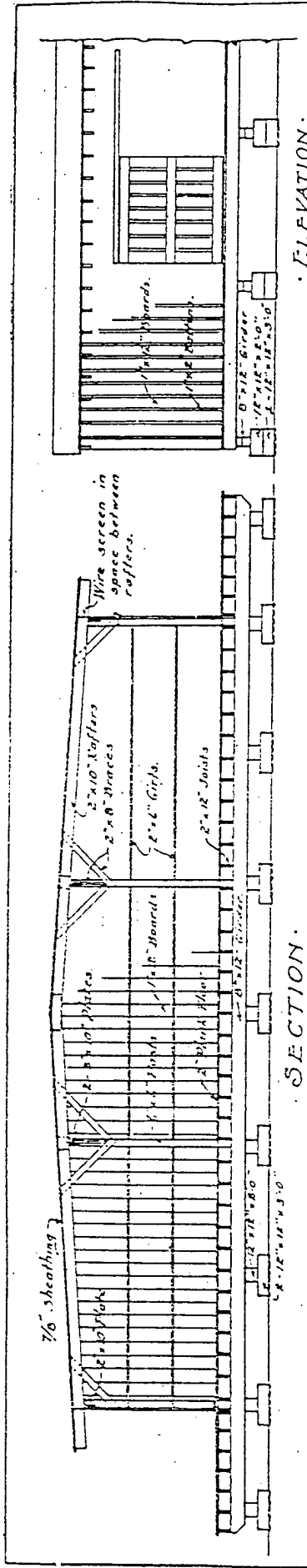

ELEVATION

SECTION

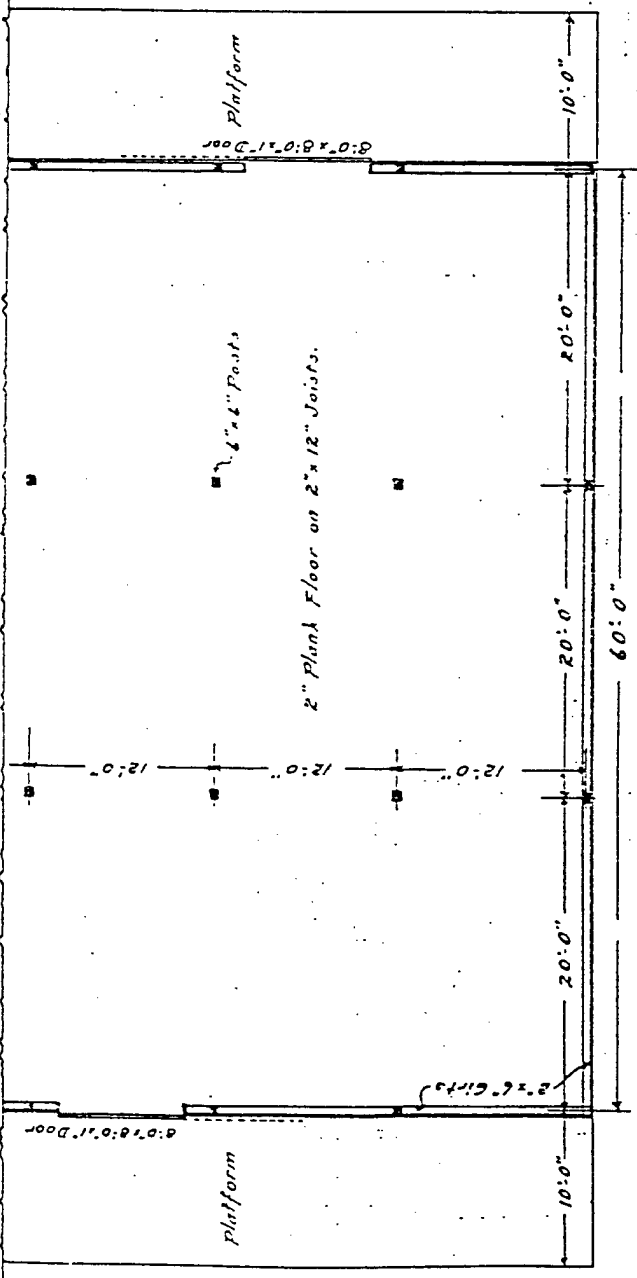

PLAN

STORE HOUSE

Scale in Feet
0 5 10

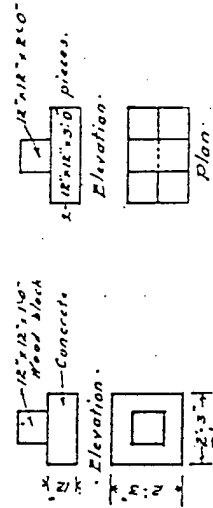

ALTERNATE
CONCRETE FOUNDATION
TIMBER FOUNDATION
Scale in Feet

TEMPORARY BUILDINGS
FOR
MOBILIZATION CAMPS

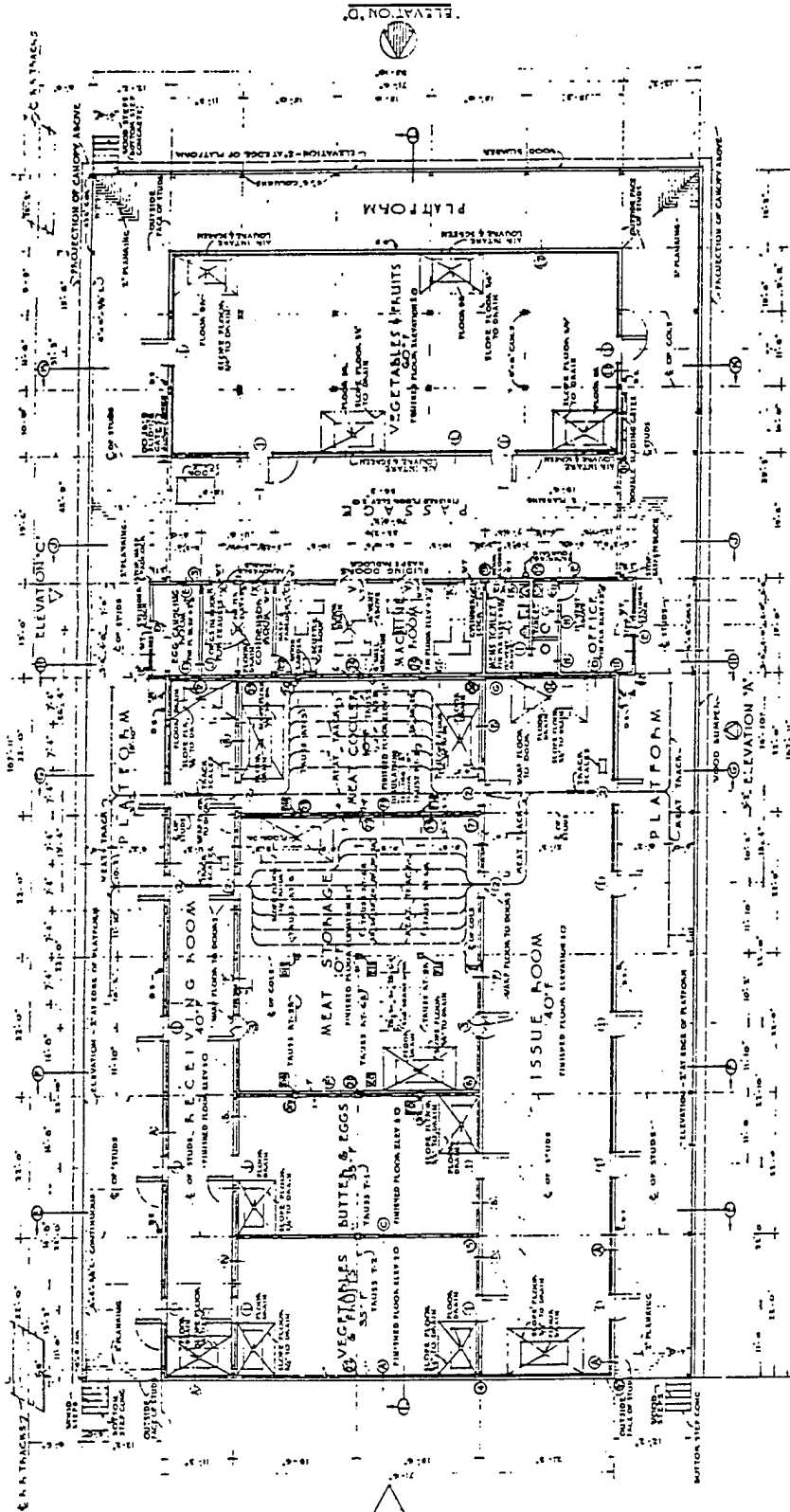

REVISED FLOOR PLAN
SCALE 1/8" = 1'-0"

INDEX

NO.	DESCRIPTION	REMARKS
1	REVISIONS GIVEN THIS SET TO SHEET 800-1004 & 1004-285	
2	REVISIONS GIVEN THIS SET TO SHEET 800-1004 & 1004-285	
3	REVISIONS GIVEN THIS SET TO SHEET 800-1004 & 1004-285	
4	REVISIONS GIVEN THIS SET TO SHEET 800-1004 & 1004-285	
5	REVISIONS GIVEN THIS SET TO SHEET 800-1004 & 1004-285	
6	REVISIONS GIVEN THIS SET TO SHEET 800-1004 & 1004-285	
7	REVISIONS GIVEN THIS SET TO SHEET 800-1004 & 1004-285	
8	REVISIONS GIVEN THIS SET TO SHEET 800-1004 & 1004-285	
9	REVISIONS GIVEN THIS SET TO SHEET 800-1004 & 1004-285	
10	REVISIONS GIVEN THIS SET TO SHEET 800-1004 & 1004-285	
11	REVISIONS GIVEN THIS SET TO SHEET 800-1004 & 1004-285	
12	REVISIONS GIVEN THIS SET TO SHEET 800-1004 & 1004-285	
13	REVISIONS GIVEN THIS SET TO SHEET 800-1004 & 1004-285	
14	REVISIONS GIVEN THIS SET TO SHEET 800-1004 & 1004-285	
15	REVISIONS GIVEN THIS SET TO SHEET 800-1004 & 1004-285	
16	REVISIONS GIVEN THIS SET TO SHEET 800-1004 & 1004-285	
17	REVISIONS GIVEN THIS SET TO SHEET 800-1004 & 1004-285	
18	REVISIONS GIVEN THIS SET TO SHEET 800-1004 & 1004-285	
19	REVISIONS GIVEN THIS SET TO SHEET 800-1004 & 1004-285	
20	REVISIONS GIVEN THIS SET TO SHEET 800-1004 & 1004-285	
21	REVISIONS GIVEN THIS SET TO SHEET 800-1004 & 1004-285	
22	REVISIONS GIVEN THIS SET TO SHEET 800-1004 & 1004-285	
23	REVISIONS GIVEN THIS SET TO SHEET 800-1004 & 1004-285	
24	REVISIONS GIVEN THIS SET TO SHEET 800-1004 & 1004-285	
25	REVISIONS GIVEN THIS SET TO SHEET 800-1004 & 1004-285	
26	REVISIONS GIVEN THIS SET TO SHEET 800-1004 & 1004-285	
27	REVISIONS GIVEN THIS SET TO SHEET 800-1004 & 1004-285	
28	REVISIONS GIVEN THIS SET TO SHEET 800-1004 & 1004-285	
29	REVISIONS GIVEN THIS SET TO SHEET 800-1004 & 1004-285	
30	REVISIONS GIVEN THIS SET TO SHEET 800-1004 & 1004-285	
31	REVISIONS GIVEN THIS SET TO SHEET 800-1004 & 1004-285	
32	REVISIONS GIVEN THIS SET TO SHEET 800-1004 & 1004-285	
33	REVISIONS GIVEN THIS SET TO SHEET 800-1004 & 1004-285	
34	REVISIONS GIVEN THIS SET TO SHEET 800-1004 & 1004-285	
35	REVISIONS GIVEN THIS SET TO SHEET 800-1004 & 1004-285	
36	REVISIONS GIVEN THIS SET TO SHEET 800-1004 & 1004-285	
37	REVISIONS GIVEN THIS SET TO SHEET 800-1004 & 1004-285	
38	REVISIONS GIVEN THIS SET TO SHEET 800-1004 & 1004-285	
39	REVISIONS GIVEN THIS SET TO SHEET 800-1004 & 1004-285	
40	REVISIONS GIVEN THIS SET TO SHEET 800-1004 & 1004-285	
41	REVISIONS GIVEN THIS SET TO SHEET 800-1004 & 1004-285	
42	REVISIONS GIVEN THIS SET TO SHEET 800-1004 & 1004-285	
43	REVISIONS GIVEN THIS SET TO SHEET 800-1004 & 1004-285	
44	REVISIONS GIVEN THIS SET TO SHEET 800-1004 & 1004-285	
45	REVISIONS GIVEN THIS SET TO SHEET 800-1004 & 1004-285	
46	REVISIONS GIVEN THIS SET TO SHEET 800-1004 & 1004-285	
47	REVISIONS GIVEN THIS SET TO SHEET 800-1004 & 1004-285	
48	REVISIONS GIVEN THIS SET TO SHEET 800-1004 & 1004-285	
49	REVISIONS GIVEN THIS SET TO SHEET 800-1004 & 1004-285	
50	REVISIONS GIVEN THIS SET TO SHEET 800-1004 & 1004-285	

LIST OF DRAWING NUMBERS APPLYING TO THIS BUILDING

DRAWING NO.	TITLE	REVISIONS	REMARKS
100	GENERAL PLAN		
101	SECTIONAL ELEVATION		
102	SECTIONAL ELEVATION		
103	SECTIONAL ELEVATION		
104	SECTIONAL ELEVATION		
105	SECTIONAL ELEVATION		
106	SECTIONAL ELEVATION		
107	SECTIONAL ELEVATION		
108	SECTIONAL ELEVATION		
109	SECTIONAL ELEVATION		
110	SECTIONAL ELEVATION		
111	SECTIONAL ELEVATION		
112	SECTIONAL ELEVATION		
113	SECTIONAL ELEVATION		
114	SECTIONAL ELEVATION		
115	SECTIONAL ELEVATION		
116	SECTIONAL ELEVATION		
117	SECTIONAL ELEVATION		
118	SECTIONAL ELEVATION		
119	SECTIONAL ELEVATION		
120	SECTIONAL ELEVATION		
121	SECTIONAL ELEVATION		
122	SECTIONAL ELEVATION		
123	SECTIONAL ELEVATION		
124	SECTIONAL ELEVATION		
125	SECTIONAL ELEVATION		
126	SECTIONAL ELEVATION		
127	SECTIONAL ELEVATION		
128	SECTIONAL ELEVATION		
129	SECTIONAL ELEVATION		
130	SECTIONAL ELEVATION		
131	SECTIONAL ELEVATION		
132	SECTIONAL ELEVATION		
133	SECTIONAL ELEVATION		
134	SECTIONAL ELEVATION		
135	SECTIONAL ELEVATION		
136	SECTIONAL ELEVATION		
137	SECTIONAL ELEVATION		
138	SECTIONAL ELEVATION		
139	SECTIONAL ELEVATION		
140	SECTIONAL ELEVATION		
141	SECTIONAL ELEVATION		
142	SECTIONAL ELEVATION		
143	SECTIONAL ELEVATION		
144	SECTIONAL ELEVATION		
145	SECTIONAL ELEVATION		
146	SECTIONAL ELEVATION		
147	SECTIONAL ELEVATION		
148	SECTIONAL ELEVATION		
149	SECTIONAL ELEVATION		
150	SECTIONAL ELEVATION		

NOTE:
THIS SHEET SERVICES AND SUPPLIES ENTIRELY
THIS BUILDING ONLY.

FORWARD, FERRER, YARBRO & BERKELEY
ARCHITECTS
1000 MARKET STREET, SAN FRANCISCO, CALIF.

PORT ADRIAN, BARRETT
CAMP THOMAS WAREHOUSE AREA
COLD STORAGE BUILDING CS-15
U.S. ARMY AIR FORCE
SAN FRANCISCO, CALIF.

DATE: 10/1/41
BY: [Signature]
CHECKED: [Signature]
APPROVED: [Signature]

NO. 444, REVISION 111 R. JORD DRAWING 10/1/41
NO. 850, OS. 111

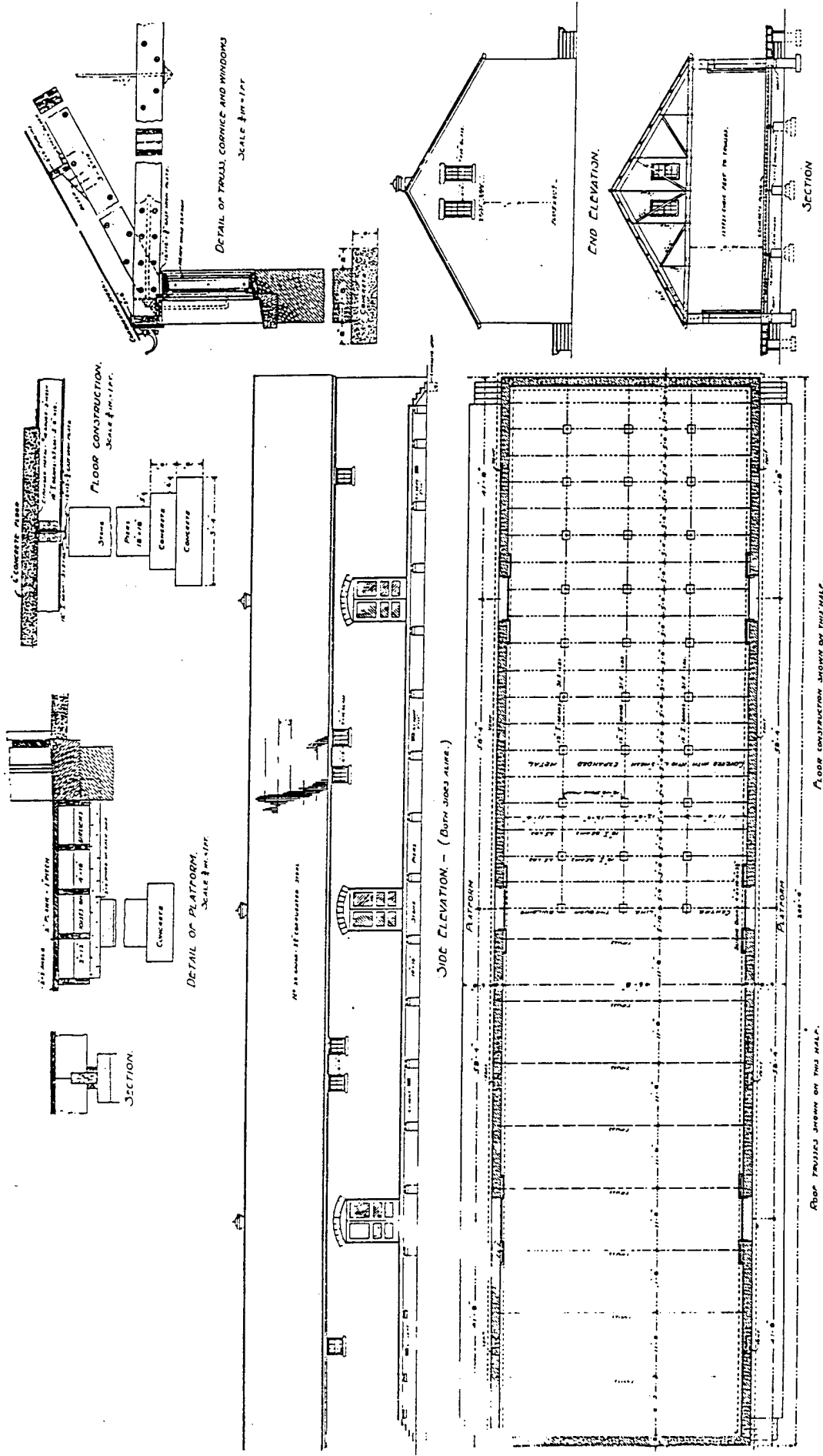

EXAMINED FOR CONSTRUCTION

193 GRANARY

3

Q.M.C.O. APRIL, 1907 NO. 350.01.611

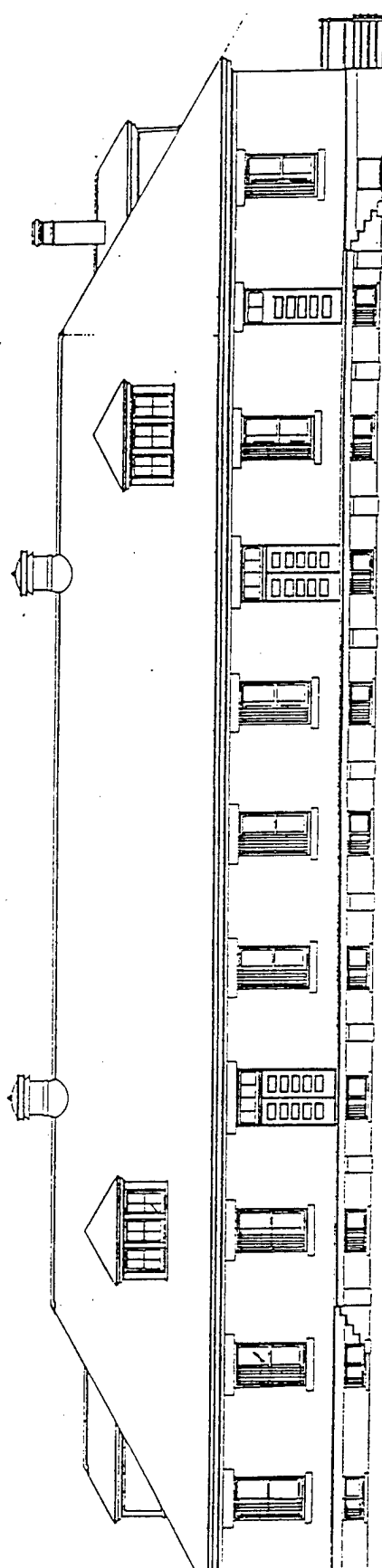

FRONT ELEVATION
Arch. No. 303-05

WOOD PLATEWORK SHOWN TO BE REPLACED BY
CONCRETE PLATEWORK
APPROVED BY
S. S. F. JOSEPH
COMMISSARY STORE HOUSE
FORT RILEY, KANSAS

COMMISSARY STORE HOUSE
FT. RILEY, KANSAS

O. M. C. O. JAN 1903
DESIGNED BY
E. H. H. H. H.

1903
HO 303-05.cii

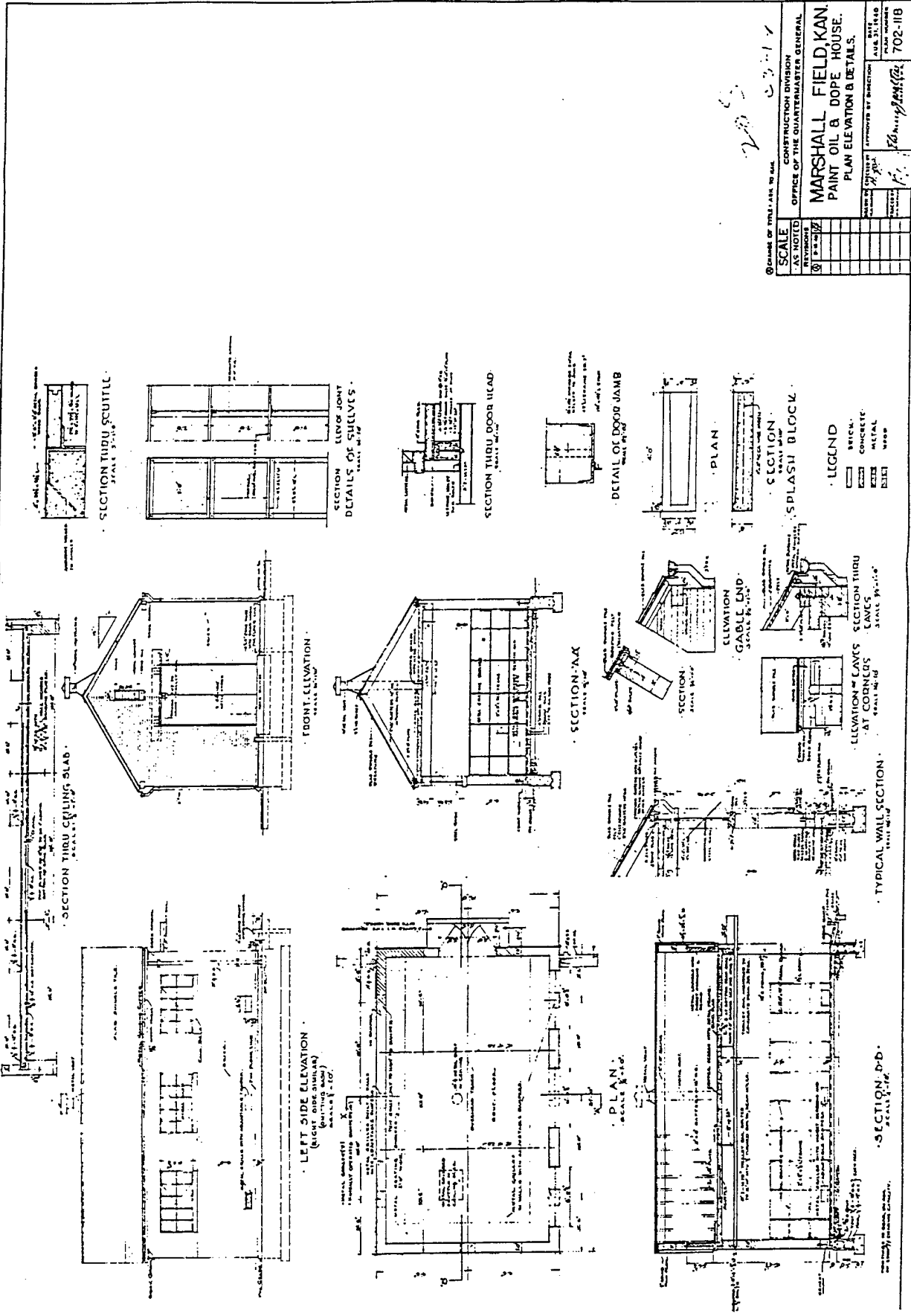

205 2317
 MARSHALL FIELD KAN. PAINT OIL & DOPE HOUSE. PLAN ELEVATION & DETAILS.

SCALE	CONSTRUCTION DIVISION	DATE
AS NOTED	OFFICE OF THE QUARTERMASTER GENERAL	AUG. 31, 1940
REVISIONS		PLAN NUMBER
1		702-11B
2		
3		
4		
5		
6		
7		
8		
9		
10		
11		
12		
13		
14		
15		
16		
17		
18		
19		
20		
21		
22		
23		
24		
25		
26		
27		
28		
29		
30		
31		
32		
33		
34		
35		
36		
37		
38		
39		
40		
41		
42		
43		
44		
45		
46		
47		
48		
49		
50		

10754.01.c11

Category: INDUSTRIAL

Type 5 d-2: Storage: Ordnance

Description:

Ordnance storage facilities are a specialized form of storage facilities that generally are recognizable as a separate building type from general storage. They form a large part of the military's storage facilities. The military constructed ordnance storage buildings to contain weapons, ammunition, and related equipment. In general, the military distributed ordnance from central depots to individual installations. This resulted in two types of ordnance storage facilities concentrations of storage buildings at the central depots and a few isolated buildings at most installations to store the ordnance needed at that installation. Ordnance storage facilities generally were one-story, utilitarian buildings with thick masonry walls. In some cases, ordnance storage facilities did incorporate architectural motifs if designed as part of an installation master plan.

Evolution:

Installation storage. The Army constructed ordnance storage facilities on Army posts throughout the time period examined during this study, 1790 and 1940. During the nineteenth century, powder magazines generally were isolated, small, windowless, one-story, masonry buildings. The typical garrison post was stocked with only one or two powder magazines. When the Army began to consolidate its troops on larger, permanent posts during the 1880s and 1890s, the Quartermaster Department issued standardized plans for ammunition storehouses that depicted one-story, masonry buildings with dormers, windows, and doors; these ammunition storehouses were similar in design to Quartermaster warehouses. The Quartermaster Department designed the buildings to allow proper ventilation of ammunition.¹³

In July 1926, the Navy's Ammunition Depot at Lake Denmark, New Jersey, suffered a disastrous explosion that destroyed the depot, portions of the Army's Picatinny Powder Depot, and nearby towns. After this, both the Army and Navy adopted a policy of constructing semi-circular concrete and steel "igloo" storage structures set into the ground surface and with surrounding earthen walls. However, funding limitations prevented the military from implementing this policy on a wide scale.¹⁴ On average installations, the typical small individual ordnance storehouse did not vary greatly in appearance from the pre-1926 above-ground ordnance storehouses. During the 1930s, the Army adopted structural clay tile as the favored construction material for ordnance storage buildings; the typical non-igloo storage building of this era was a one-story, above-ground, structural clay tile structure with a vented gable roof.

¹³ NARA, Cartographic Branch, RG 77, Standard Plans of Army Post Buildings, 1891 -1918, Plans, 24, 46, 103, 128, 137, 282, 390.

¹⁴ Harry Thompson and Lida Mayo, *The Ordnance Department, Procurement and Supply*, Washington, D.C. Government Printing Office, 1960, 360-361.

On Army installations not specifically designated as ordnance production or storage facilities, the growth in garrison size and amount of ordnance used can be seen in the evolution of ordnance storage facilities from a single powder magazine at nineteenth-century western posts to entire complexes of magazines located several miles away from the main cantonment area by the end of the 1930s. The installation mission determined the number of ordnance storage facilities required at the installation. For example, artillery installations used more ordnance and thus were supplied with more extensive ordnance storage buildings.

Depots and Arsenals. The Ordnance Department operated ordnance production facilities and regional ordnance storage depots. The storage buildings at nineteenth-century ordnance production and regional depots were two-story, masonry, gable-roofed buildings that were much larger than the single powder magazines at garrison posts. The storage facilities at Watervliet Arsenal, New York, were large, windowless, stone buildings. The Ordnance Department operated an ordnance depot for the Department of the Missouri during the mid-nineteenth century at Ft. Leavenworth, Kansas. The depot was housed in two, two-story, brick warehouses, with regular window openings and simple decorative brickwork, including pilaster strips and corbelled cornice.

After the 1926 Lake Denmark Ammunition Depot explosion, new ordnance storage buildings were constructed at Picatinny Arsenal, New Jersey. Different types of storage facilities were constructed for different types of ordnance. For stable materiel, above-ground, rectangular, structural clay tile or brick buildings with loading docks along the long side were constructed. For more volatile ordnance and raw materials, igloo storage structures were built. The post-1926 ordnance storage buildings were dispersed to prevent the spread of explosions. Dispersed ordnance storage facilities of these two types--either above-ground, brick or structural clay tile magazines or partially below-ground, concrete igloos--were the prevalent pattern of layout and design at large-scale ordnance storage installations.

Association:

Ordnance storage buildings are associated with the evolution of weapons technology and illustrate the general evolution of military logistics and supply in relation to weaponry. Ordnance storage buildings, in general, do not possess individual historic or architectural significance. The storage of ordnance alone is not an historically significant context; however, ordnance storage facilities may be associated with other significant historic contexts, such as a significant method or type of construction or a significant ordnance production activity. Ordnance storage buildings may contribute to an historic district if they are part of a cohesive concentration of buildings that possess historical or architectural significance, particularly if the historical significance of the district is related to military ordnance. A complex of ordnance storage buildings on an installation with the primary mission of ordnance production and storage may form a distinctive district, while the few ordnance storage buildings on other types of installations may be contributing support buildings in an historic district, if they are physically related to the district. The dispersed layout of twentieth-century ordnance storage facilities affects their ability to contribute to historic districts.

Integrity:

To possess integrity, ordnance storage facilities should retain most of their design, setting, and exterior construction materials from the period of significance of the historic district.

Nineteenth-century ordnance storage facilities usually have undergone the most substantial modifications and may have been adapted for use for other types of storage or, in cases of large ordnance depots, even for offices. Ordnance storage facilities from the 1920s and 1930s often have undergone little modification due to their specialized design.

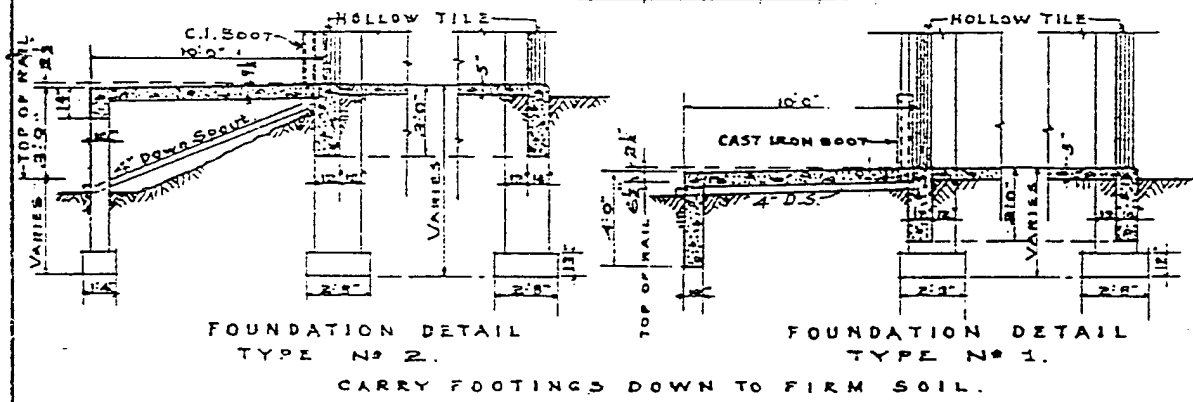
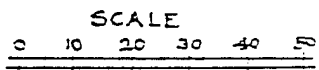
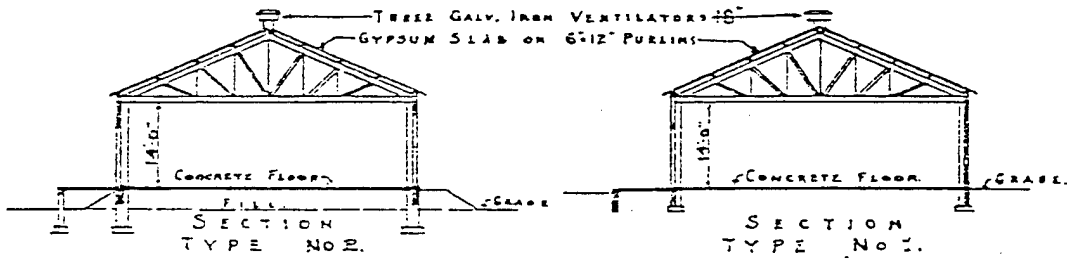
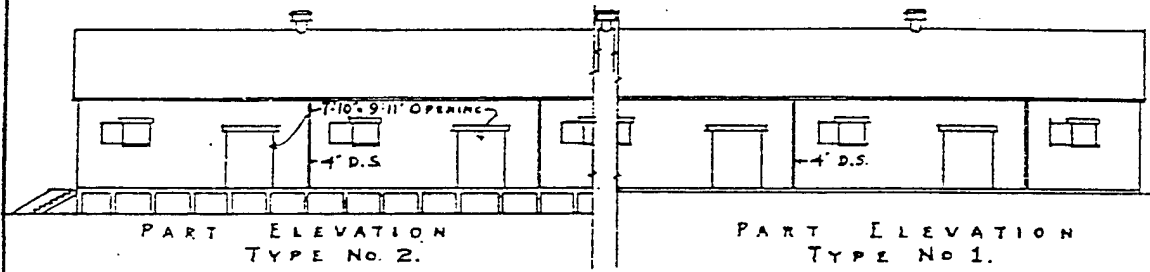
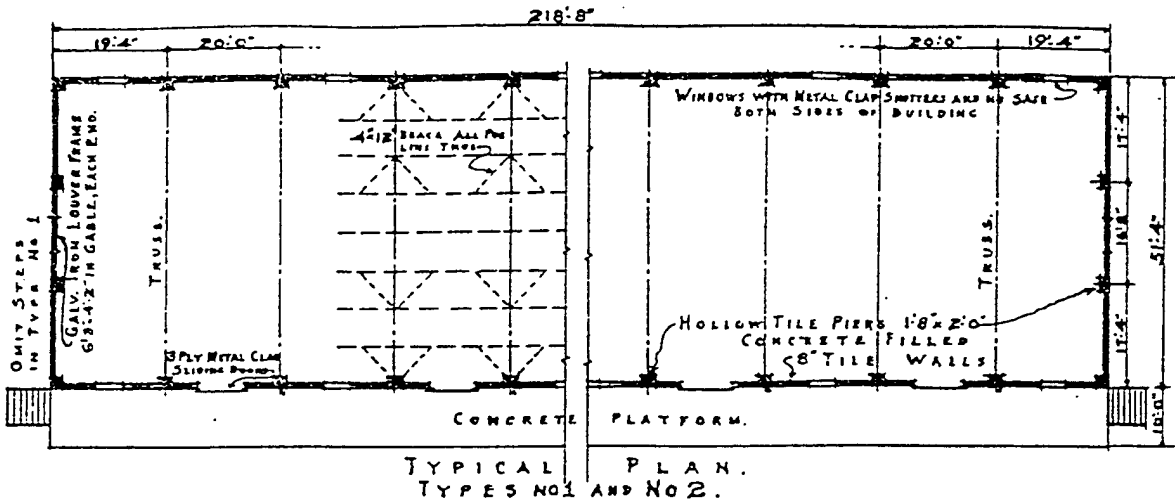

FOR DETAILS SEE DRAWING (652-7 FOR TYPE NO 1.
652-9 FOR TYPE NO 2.

CONSTRUCTION DIVISION OF THE ARMY
STANDARD MAGAZINES
TYPES NO 1 AND NO 2.

SB-23

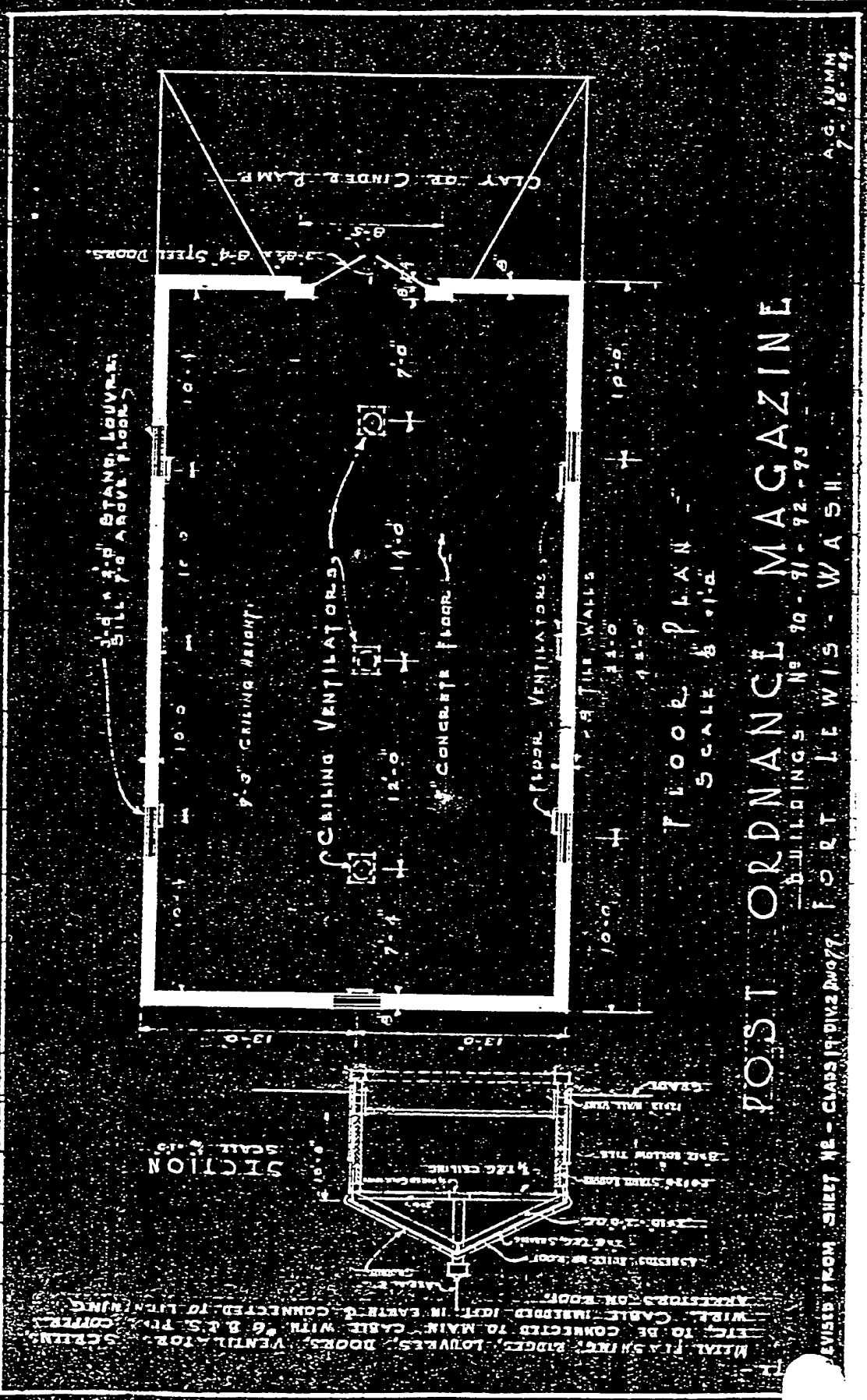

A.G. LUMM
7-16-49

POST ORDNANCE MAGAZINE

BUILDINGS No 90-31-92-73

FORT LEWIS - WASH.

REVISED FROM SHEET No - CLASS 19 DIV 2 DWG 77

FLOOR PLAN
SCALE 8'-1" = 1'-0"

SECTION
SCALE 1/2" = 1'-0"

Metal Flashing, Ridge, Louver, Door, Ventilator, Sill, etc. to be connected to main cable with #6 B.S.P. Control wire. Cable imbedded in earth & connected to lightning arrester on roof.

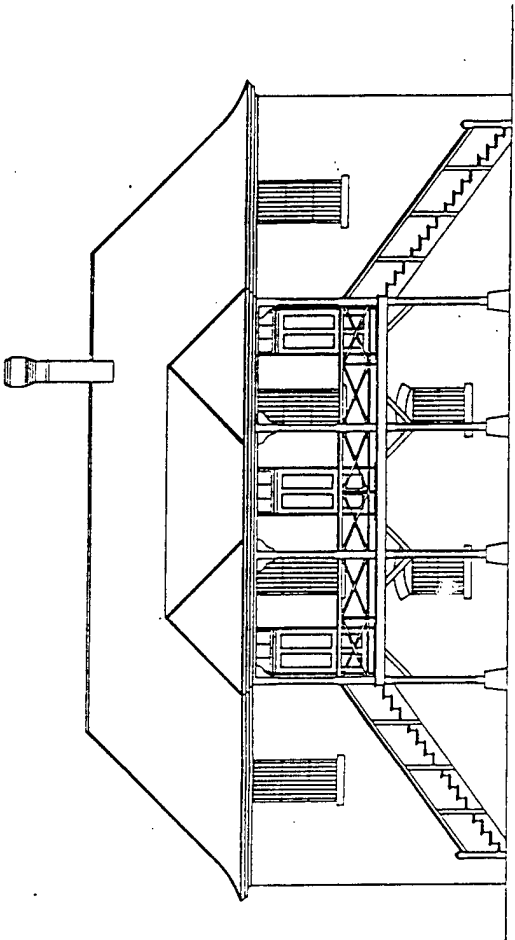

Front Elevation

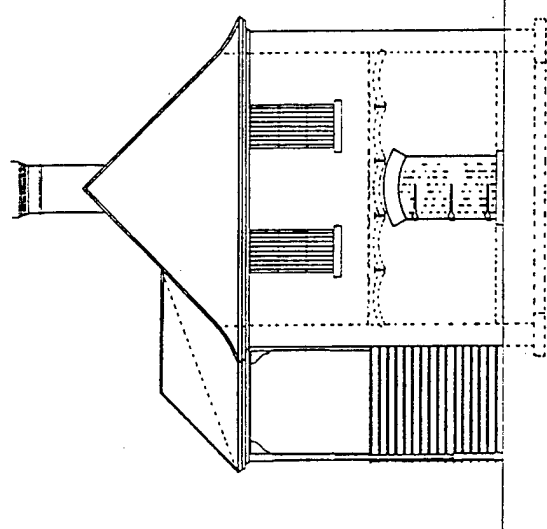

End Elevation

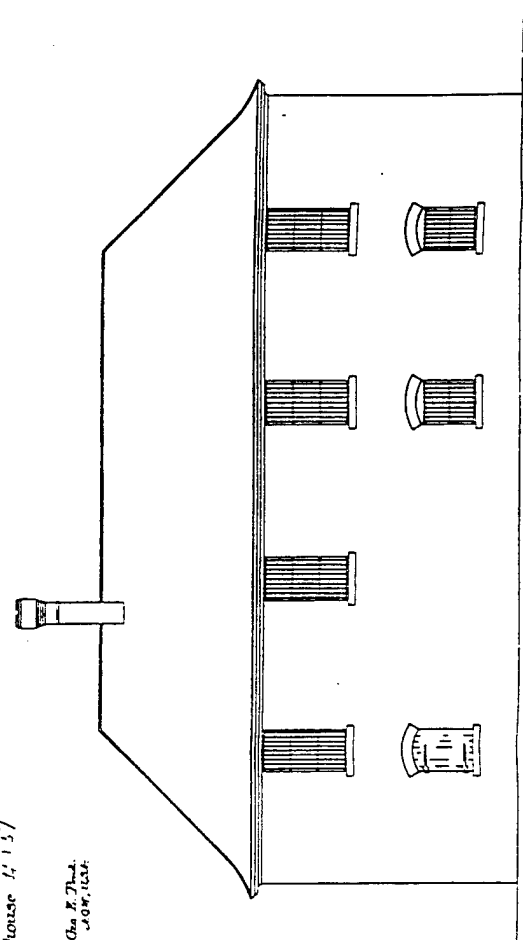

Rear Elevation

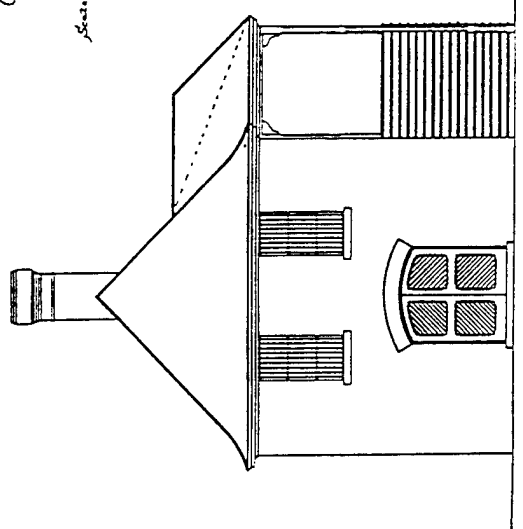

End Elevation

Ordnance Storehouse 41157

Fort Mygale, Alaska
 Capt. Geo. F. Flint
 1898, 1904
 Scale, 1/8" = 1'

Block-1
 U File A14-1

127
 U.S. Army
 HO 307.0157

Category: INFRASTRUCTURE

Type 6 a: Power Plants/Electrical Systems

Description:

Power plants and their attendant distribution systems on military installations provided power to manufacturing establishments and heating and electricity to residential communities. Central power plants generated power that was distributed through a system of substations. The central power plants generally were large industrial buildings, while the supporting substations were small, utilitarian buildings. Both power plants and substations were constructed of masonry. In some cases, the central power plants were placed in prominent locations and given high-style architectural treatment. The location and prominence of power plants depends on the installation mission and date of construction. Power plants for garrison posts and training stations usually were located away from the main area of the installation and were unadorned, utilitarian structures. Late nineteenth- and early twentieth-century industrial installations, such as shipyards and arsenals, received large, prominent power plants that symbolized the military's growing industrial power. Mid twentieth-century power plants usually display more utilitarian, functional design, and usually were located away from the main area of the installation.

Evolution:

During the late nineteenth century, the Army consolidated its troops in larger installations with permanent construction and improved the living standards on its posts. During the 1880s and 1890s, the Quartermaster Department began to experiment with integrated steam heating systems on installations. The first integrated system was installed at Ft. Riley, Kansas, during the 1880s. Ft. Riley's central steam heating plant used four miles of pipe to send steam throughout the post. This plant also captured and recondensed the steam to avoid a build-up of calcium in the boilers.¹

The Army introduced electric lighting into barracks in 1891. The need for power stations grew as the Army expanded electrical service at U.S. installations. Installations constructed after the 1890s were equipped automatically with a power plant.² Power plants were added onto older installations as systems and facilities were modernized. Power plants usually were one-story, masonry buildings with tall chimney flues. During the wave of new installation construction during the 1930s, the Army constructed larger, two-story, masonry power plants. Smaller complexes within an installation, such as a hospital complex, sometimes were equipped with a separate power plant. Substations were constructed to aid the distribution of power around the installation through a system of electrical substations and transformer huts.

¹ National Archives and Records Administration, Record Group 92, Office of the Quartermaster General, Consolidated Correspondence File, Boxes 909 - 916, Ft. Riley.

² David A. Clary, *A Life Which is Gregarious in the Extreme: A History of Furniture in Barracks, Hospitals, and Guardhouses of the United States Army, 1880-1945*, MSS, U.S. Department of the Interior, National Park Service, Harpers Ferry Center, Harpers Ferry, West Virginia, 1983, 34.

Association:

Power plants either are associated with the primary mission of an installation, such as at shipyards, manufacturing facilities, and some air fields, or are secondary support structures that provided heat and electricity to housing and administration areas. Power plants also are related to the developing technology of the industrial and machine ages. Power plants associated with the primary mission of installations often are prominent buildings in central locations that illustrate their relationship to the industrial process at the installations. This type of power plant should be evaluated for its association with the mission of the installation and for its architectural significance. Power plants that provided power to residential and administrative buildings are not related to the primary mission of the installation; their role as secondary, support structures is reflected in their utilitarian designs and isolated locations. Power plants in this second category usually are not associated with a significant historic context and thus do not possess historical or architectural significance as individual buildings; however, they may contribute to an historic district if they are in an area with a concentration of historic properties.

Integrity:

To possess sufficient integrity to contribute to an historic district, power plants and their attendant support structures should retain most of the exterior design features, materials, and setting from their period of significance. If the building is under consideration as an individual historic property, then the interior also should retain sufficient integrity of materials, spatial arrangement, and equipment to represent the period of significance. Often power plants have been upgraded or expanded. Common modifications include changes to original window and door openings and the construction of additions. Character-defining features of power plants include the pattern of openings, the distinctive tall chimney stacks of many early power plants, construction materials, and the architectural vocabulary specific to the power plant. For example, the monumental neoclassical design elements of turn-of-the-century power plants are important elements of the buildings' character, while Art Deco or modern architecture elements are defining features of 1930s power plants. These facilities still may possess integrity if they retain the majority of their design, setting, materials, association, and workmanship from their period of significance.



1939 Electrical System Station at McChord AFB, WA



1938 Central Heating Plant at McChord AFB, WA

Category: INFRASTRUCTURE

Type 6 b: Water and Sewage Systems

Description:

Water and sewage systems comprise buildings and structures that provided clean water and disposed of waste water on military installations. In some cases, elements of the water system, such as water towers, were incorporated into the installation design as prominent architectural features. In other cases, they were simple utilitarian buildings. Water and sewage system facilities usually were constructed of permanent materials. Other than the water towers, the remainder of the water and sewage system buildings and structures usually were located away from the main area of the installation.

Evolution:

During the first three-quarters of the nineteenth century, water supplies were collected through reservoirs, roof catchments, cisterns, and wells. The growing sophistication of urban life was epitomized by the introduction of indoor plumbing and electricity at the end of the nineteenth century. When the Army consolidated its troops in larger and more permanent installations during the 1880s and 1890s, the Quartermaster Department included plans for water storage and distribution systems at the new and expanded posts. The earliest water tower identified in this study was constructed between 1876-1878 as part of the quartermaster depot at Ft. Sam Houston, Texas. The 90-foot high structure contained a watchman's room, a 6,400-gallon water tank, and a four-faced clock. The water tower was part of a water distribution system in conjunction with rain cisterns and a reservoir.

The inclusion of indoor plumbing and steam heat in Army housing during the 1880s increased the complexity of the water supply and distribution. By 1892, all but 130 company barracks had hot and cold running water. By 1893, most posts included planned sewer systems. This necessitated the development of water supply infrastructure. By 1896, the Quartermaster Department spent more than \$250,000 on water supply, plumbing, sewerage and drainage. These technological advances required more complex engineering answers to the problems of water distribution and waste removal.³

The Quartermaster Department issued standardized plans for metal water tanks raised on wood trestle towers during the 1890s.⁴ These utilitarian water towers were probably the most common type of water towers found on Army installations. Other facilities required for water distribution systems included pumping stations.

³ David A. Clary, *A Life Which is Gregarious in the Extreme: A History of Furniture in Barracks, Hospitals, and Guardhouses of the United States Army, 1880-1945*, 21-22.

⁴ NARA, Cartographic Branch, RG 77, Standard Plans of Army Post Buildings, 1891-1918, P.I. NM-19, Entry 411, Plan 16.

In some cases, water towers were designed as prominent elements in the installation plan. At Ft. Sheridan, Illinois, the 1890 water tower is a Romanesque stone tower that joins two barracks and serves as an important landmark on the installation. Water towers again were used as features of installation design during the nationwide construction program of the 1930s. Barksdale AFB, Louisiana, and Randolph AFB, Texas, are examples of installations with unique water towers that serve as architectural landmarks, as well as water storage facilities. The water tower at Barksdale originally was a plain standpipe, but in 1934, it was encased in cladding to resemble a castle tower.

The Quartermaster Department also engineered sewage and water treatment systems. Generally these facilities were located apart from the rest of the installation. In some instances, the early sewage treatment plants, though originally located far from the main parade ground, have been overtaken by subsequent post development. At the World War I training camps, the water and sewage facilities were among the only buildings of permanent construction, and thus may predate much of the rest of the permanent construction. By the 1930s, sewage and water treatment plants were basic elements of installation planning. The results of the field survey conducted for this project indicated that the water and sewage facilities constructed during this prolific building period were not built according to standardized plans. Building designs were the result of site requirements and installation size. In rare instances, architectural elements were incorporated into the-design to produce more than the basic, functional structure.

Association:

Water distribution and sewage treatment facilities are associated with the development of an infrastructure on military installations comparable to that of contemporary cities. These facilities usually are support structures that do not possess historical or architectural significance, and often are located apart from the main area of the installation, and thus are physically isolated. However, they may be contributing resources in an historic district if they are located in an area with a concentration of historic properties. In some instances, the buildings may possess architectural significance as representatives of important types or methods of construction. In several cases, installation water towers possess high artistic merit, are integral elements in the installation plan, and have become symbols of the installations; in these cases, they may be individually eligible.

Integrity:

If the water and sewage treatment facilities possess significance, then their integrity, that is, their ability to convey that significance, must be evaluated. If the structure is significant for its architectural merit, then the important features of the structure must be identified. Since these structures were not the result of standardized design, no universal list of character-defining features was derived from examination of the existing examples. To possess architectural integrity, water distribution and sewage treatment facilities should retain most of their design and external construction materials from their periods of construction. Setting also is an important element of integrity, particularly if the structure was part of an installation master plan, as in the

case of some water towers. Other important elements of integrity for these buildings include shape, height, pattern of openings, materials, and ornament.

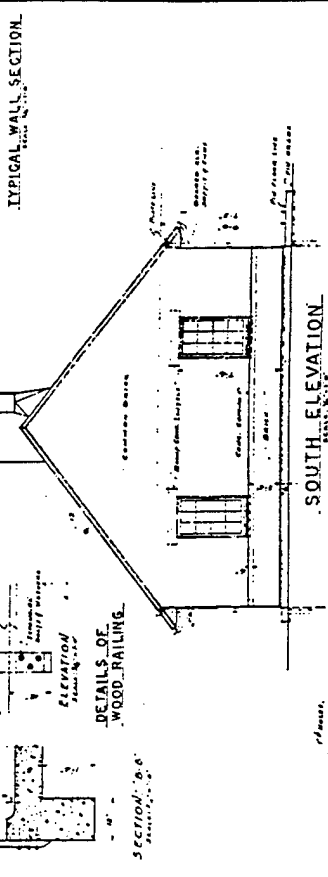
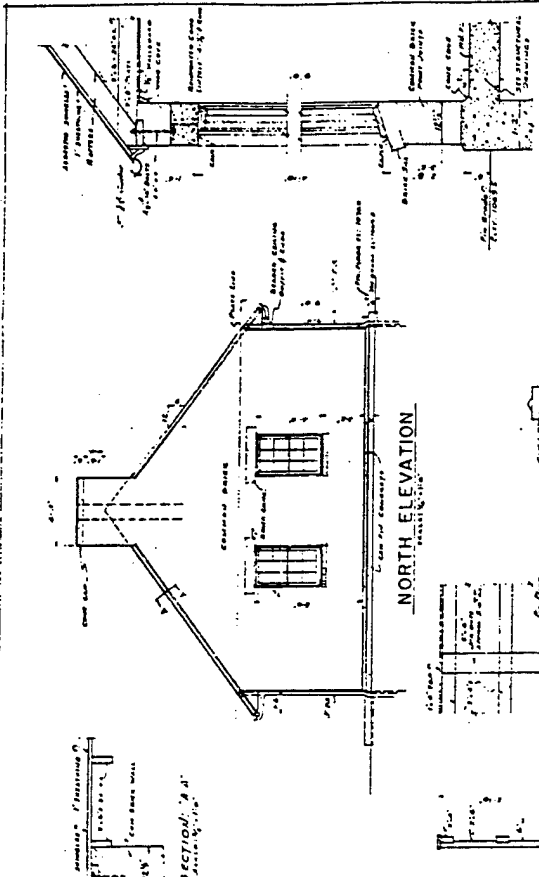

WINDOW & DOOR SCHEDULE

NO.	DESCRIPTION	FINISH	MARKET
1	Double Hung Window	White	Standard
2	Double Hung Window	White	Standard
3	Double Hung Window	White	Standard
4	Window	White	Standard

PLAN
 A small detail plan of a window or door.

SEWAGE TREATMENT PLANT CONTROL HOUSE PLANS & ELEVATIONS

HOWARD, BERGER, JARVIS & BARDHOFF
 ARCHITECTS
 1001 E. 14th St.
 S.W. Corner
 PORTLAND, OREGON

DATE: 12/10/59
 SHEET NO. 12

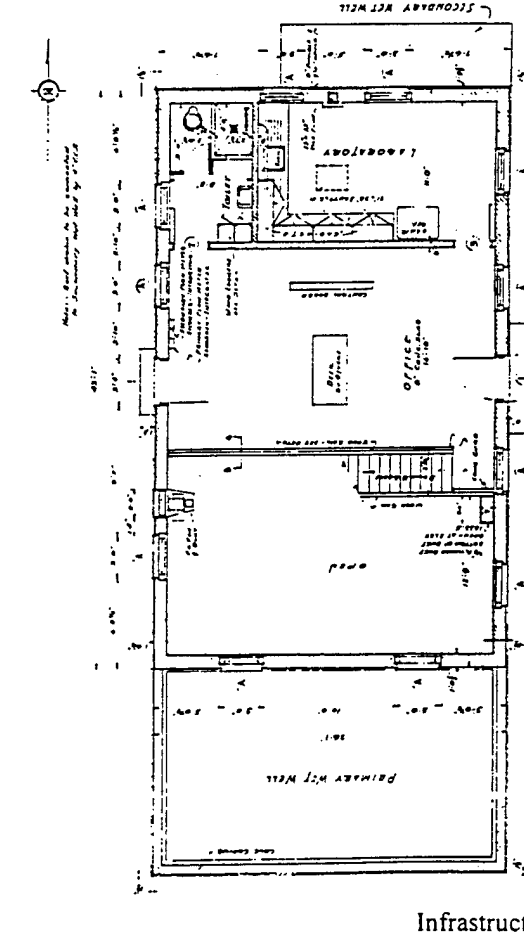
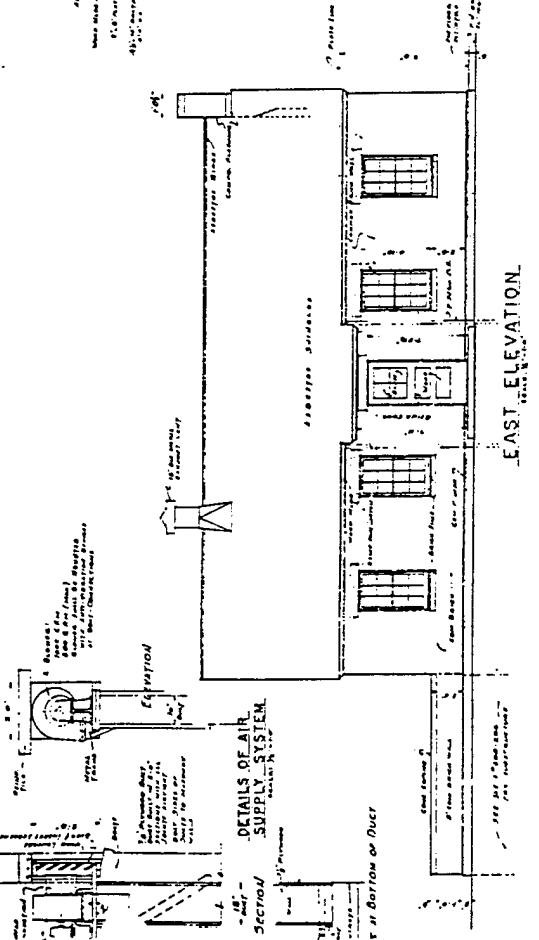

DETAILS OF WOOD LOCKERS
 A detailed view of a wood locker showing its construction and hardware.

Category: RECREATION/SOCIAL/CULTURAL/RELIGION

Type 7 a: Assembly Halls

Description:

Assembly halls were built during the late nineteenth and early twentieth centuries to provide an indoor facility to assemble enlisted personnel for lectures and for live entertainment. They pre-date the construction of movie theaters on military installations. The buildings constructed for this purpose generally were one- or two-story rectangular buildings, often with the front entrance in the gable end. Assembly halls often had stages along the rear wall. They often were built of wood frame construction.

Evolution:

During most of the nineteenth century, Army posts had few buildings specifically devoted to educational or recreational purposes. Quartermaster Department standardized plans for administration buildings often included rooms for use as libraries, chapels, assembly rooms, and school rooms. Following recommendations in 1878 from a board of officers, installation commanders were allowed to use post funds to construct separate buildings for schools, chapels, reading rooms, and libraries. The Quartermaster's Department furnished an increasing number of posts with these types of buildings. The Quartermaster Department issued a standardized plan for a separate assembly building during the 1890s. The plan depicts a one-story building with windows along the sides; the interior contained an open assembly area facing a stage at the end of the building. This basic plan was constructed until the early twentieth century. Assembly halls provided space to assemble troops for lectures and also for entertainment such as amateur theatricals and dances.¹

The assembly hall as a separate building on Army posts was short-lived. It was subsumed into the broader range of recreational buildings constructed during the twentieth century, such as movie theaters and gymnasiums. Movie theaters were constructed at most installations during the 1930s. The Quartermaster Corps often included assembly rooms in their plans for gymnasiums during the 1930s. Red Cross and YMCA buildings also were used to provide much of the same entertainment functions of assembly halls.

Association:

Assembly halls are associated with the growth of social and cultural amenities provided on military installations during the late nineteenth and twentieth centuries. They may not possess historic significance as individual buildings, but can be contributing buildings in an historic

¹ Erna Risch, *Quartermaster Support for the Army - A History of the Corps 1775-1939*, Washington, D.C., Government Printing Office, 1962. Reprinted 1989, 490; National Archives and Records Administration, Cartographic Branch, Record Group 77, Standard Plans of Army Post Buildings 1891-1918, P.I. NM-19, Entry 411, Plan 72.

district. As part of an historic district, they may help to convey the character of early twentieth-century military life and the character of the installation's layout and architecture.

Integrity:

To possess integrity, assembly halls should retain the majority of its design, materials, workmanship, location, setting, and, association from its period of significance. In cases where an existing building was adapted to serve as an assembly hall, the alterations may have attained significance and should be evaluated within their appropriate context. Character-defining features of assembly halls can include porticos, ticket vestibules, and marquees. Architectural ornamentation is concentrated on the front facade of most assembly halls and may include a Colonial or Mission Revival portico, depending on the region. If the building is under evaluation for historic significance as an individual building, then the interior integrity also must be assessed. Character-defining elements of the interior include the original configuration of interior space, materials, and workmanship.



1900's Assembly Hall at Presidio of Monterey, CA

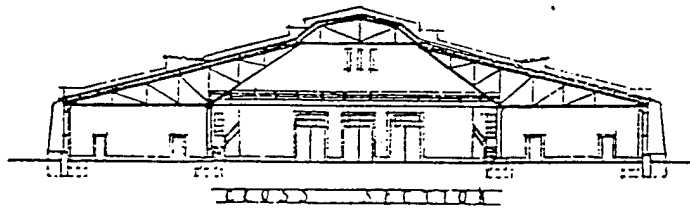

CROSS SECTION



FRONT ELEVATION

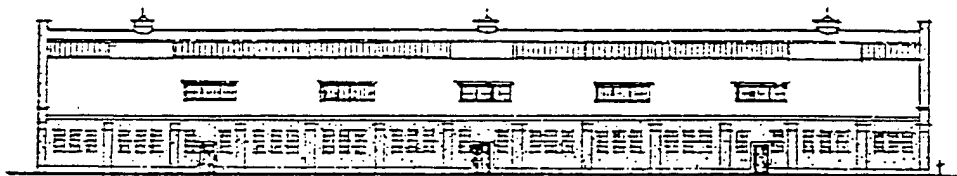

SIDE ELEVATION

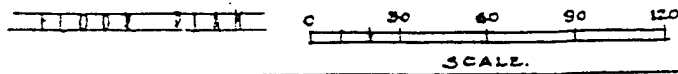
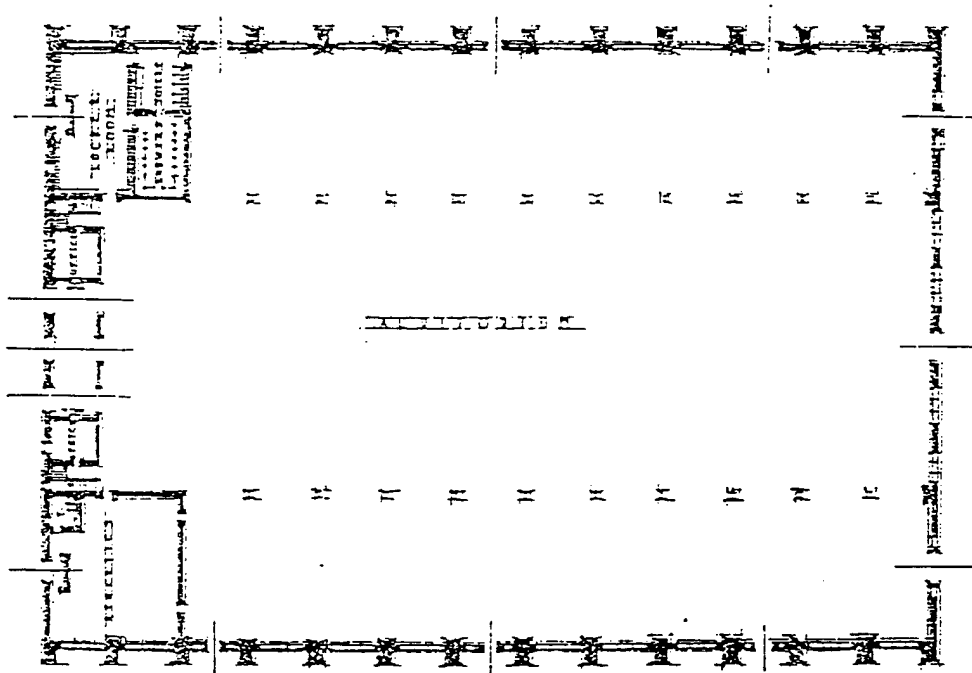

FOR DETAILS SEE DRAWINGS 608-19-20-21-22.

CONSTRUCTION DIVISION OF THE ARMY
 AUDITORIUM
 200'-0" x 300'-0"

SB-24

Category: RECREATION/SOCIAL/CULTURAL/RELIGION

Type 7 b: Athletic Facilities

Description:

Athletic facilities on military installations included gymnasiums, bowling alleys, and outdoor facilities, such as swimming pools, golf courses, playing fields, and stadia. These facilities usually followed the same design traditions as the same types of civilian facilities of the same era.

Evolution:

During the late nineteenth century, the Army devoted increased attention to the improvement of living conditions on its posts. The health, morale, and well-being of troops were considered important factors in Army performance. The Army began to encourage recreational activities and exercise. For instance, Quartermaster General M. C. Meigs supported the construction of bowling alleys, though no funds were available for this purpose. Meigs also published an article, distributed widely among post libraries, on how troops could make their own billiard table and bowling alley. By the early twentieth century, some bowling alleys had been built at various posts. The Quartermaster Corps issued a standard plan for bowling alleys in 1908.²

By the early twentieth century, the Army had incorporated athletic facilities into its building program. Often athletic facilities were combined with other functions such as the post exchange. The Quartermaster Department began to issue standardized plans for a combined gymnasium, bowling alley, and post exchange in 1903. The Quartermaster Department issued a separate standardized plan for a gymnasium building in 1904. Though the Quartermaster Department issued plans for gymnasiums and exchanges, 1904 Quartermaster regulations stated that post exchanges, gymnasiums, bowling alleys, and other places of amusements could be constructed only with materials at hand, and must incur no cost to the government and must utilize the labor of troops.³ Until World War I, gyms and post exchanges often were combined in a single building.

During the 1920s, the Army received few funds for new construction. Recreational facilities were funded through private means. For instance, the Secretary of War authorized the establishment of a Recreational Center Board at Ft. Benning, Georgia. The board raised funds and oversaw the planning and construction of athletic and recreational facilities. Athletic

² Risch, *Quartermaster Support for the Army*, 489-490; NARA, Cartographic Branch, RG 77, Standard Plans of Army Post Buildings 1891-1918, Plan 216A.

³ NARA, Cartographic Branch, RG 77, Standard Plans of Army Post Buildings 1891-1918, Plans 154, 154A, and 159; War Department, General Staff, *Manual for the Quartermaster's Department, United States Army, 1904*, Washington, D.C., Government Printing Office, 1904, 29.

facilities constructed by the Board included the Doughboy stadium, outdoor playing fields, and a swimming pool.⁴

During the wave of new, permanent construction during the 1930s, athletic facilities became typical features of Army installations. The results of the field survey conducted as part of this study indicate that the type, design, and size of athletic facilities did not follow standardized plans and varied from installation to installation. Gymnasiums were common buildings on posts from this period. They usually were masonry, rectangular buildings that were designed in the same regional architectural style as the other buildings of the installation.

Outdoor sporting facilities also were common elements of Army posts. Polo remained a popular sport, in keeping with the equestrian culture of the Army. A few riding halls were constructed for indoor equestrian training. Golfing became a popular sport and the number of golf courses proliferated. Where land permitted, new golf courses were laid out; if land was scarce, the parade ground was adapted to a nine-hole golf course. During the late 1930s and early 1940s, golf clubhouses were constructed. Other outdoor sports included tennis, swimming, and boating. Swimming pools were constructed using both appropriated funds and non-appropriated funds. Those swimming pools constructed by the Quartermaster Department generally included one-story bathhouses.

Association:

Athletic facilities are associated with the growth of social and cultural amenities provided to military personnel during the twentieth century. They also are associated with the general rise of interest in organized sports and fitness during the early twentieth centuries, which is evident from the construction of buildings, structures, and fields specifically for sports in towns, on college campuses, and on military installations. Athletic facilities are recreational facilities that are located typically at military installations with large numbers of resident military personnel. Athletic facilities generally do not possess individual historic significance, but can be contributing features to an historic district. The athletic facilities on military installations often are functional structures without significant historical associations. Selected examples may be architecturally significant for their design or construction or may have developed into symbols of an installation or service branch.

Integrity:

To possess architectural integrity, athletic facilities should retain most of their architectural ornamentation, design features, and exterior materials from the period of significance. Where subsequent additions or renovations have occurred, the building may have integrity if it retains the majority of its character-defining features, such as its location in the installation plan, materials, workmanship, and design, including exterior openings, proportions, and massing.

⁴ Robinson Fisher Associates, *Historic Building Survey: Fort Benning, Georgia*, MSS, Fort Benning, Georgia, 1987.



1904-05 Gymnasium at Vancouver Barracks, WA

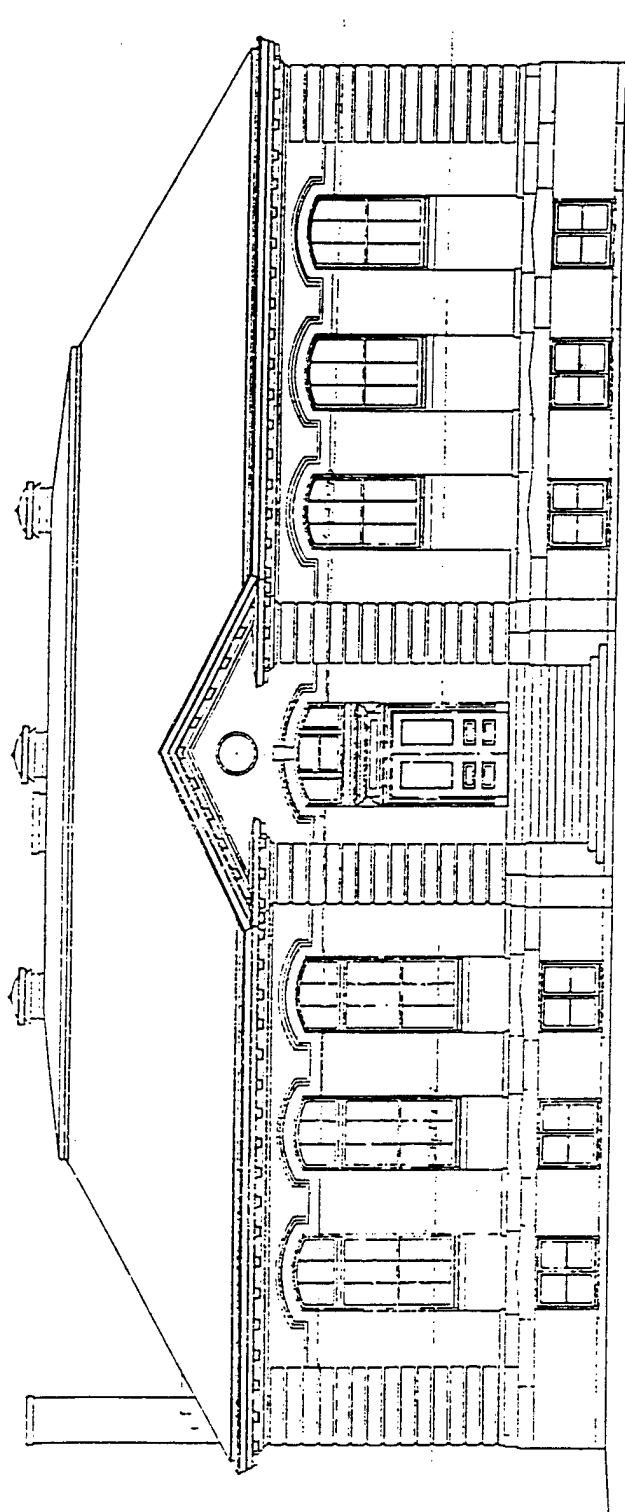

FRONT ELEVATION
Scale: 1/8" = 1'-0"

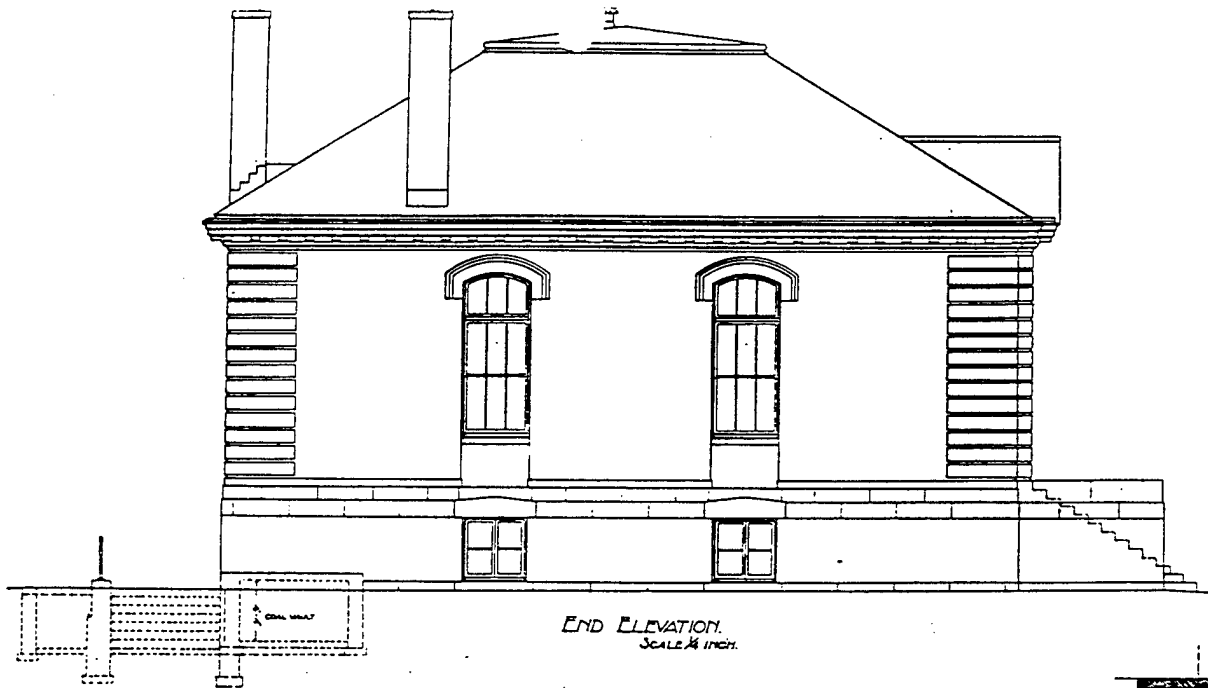

END ELEVATION.
SCALE 1/4" = 1'-0"

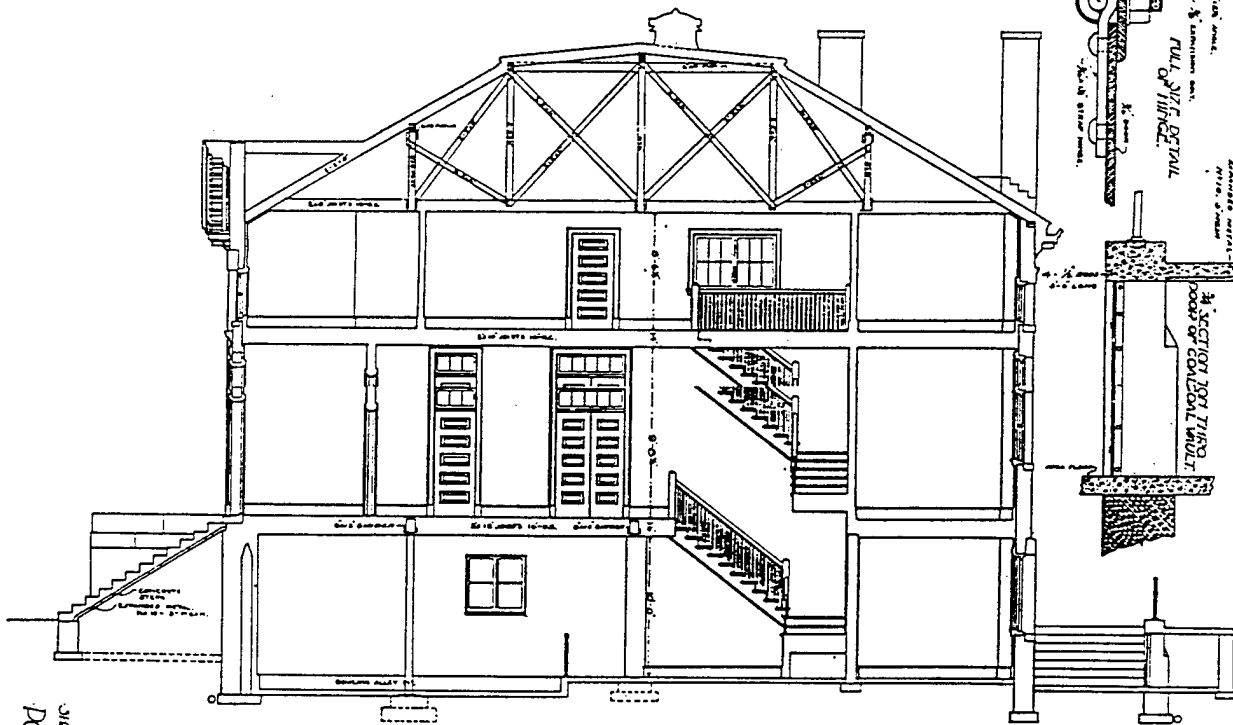

TRANSVERSE SECTION.
SCALE 1/4" = 1'-0"

SHEET NO. 6 - 174 - CONSTRUCTION & DETAILS
 POST EXCHANGE & GYMNASIUM
 Q.M.C.D.
 MAY 1906
 NO. 405.01.C11



North Elevation

Confederal Mass Hall, Metchen & Berney

as proposed by
T. H. H. H. H. H.

Mr. George Jones

By Capt. Geo. I. H. H.
of C. H. H.

Scale 1/4" = 1'-0"



West Elevation

PLAN OF CONFEDERAL AND STATE HOUSE,
FORT RILEY, KANSAS.

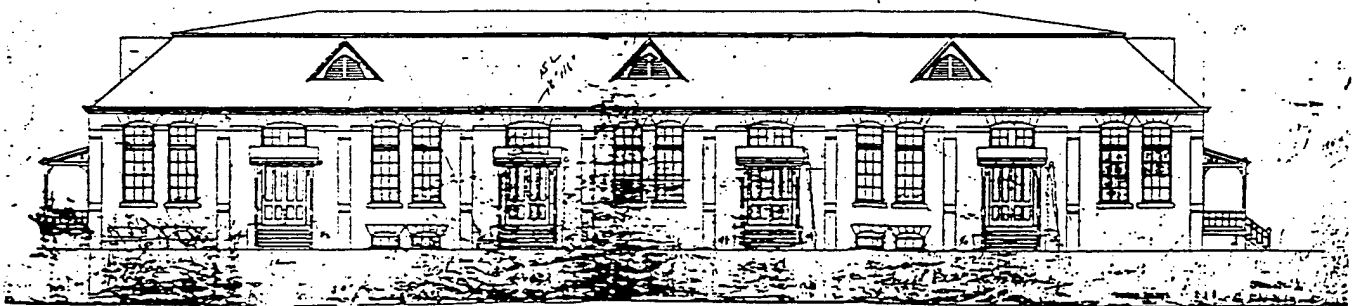

NO 210-05.cit

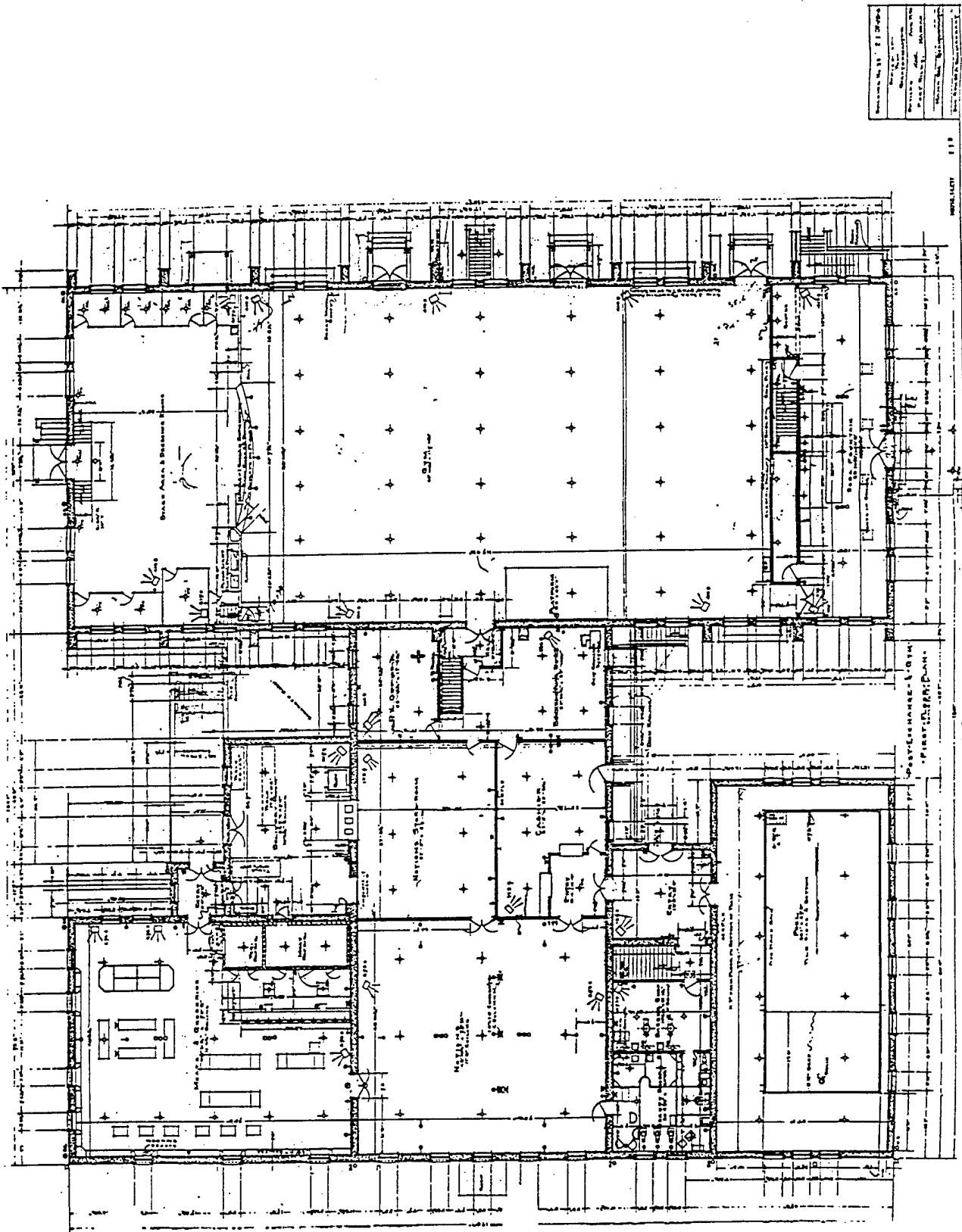

Project No. 11 - 11 2000	Scale: 1/8" = 1'-0"
Client: [illegible]	Architect: [illegible]
Date: [illegible]	Sheet No. [illegible]

NO210, 14, CIT

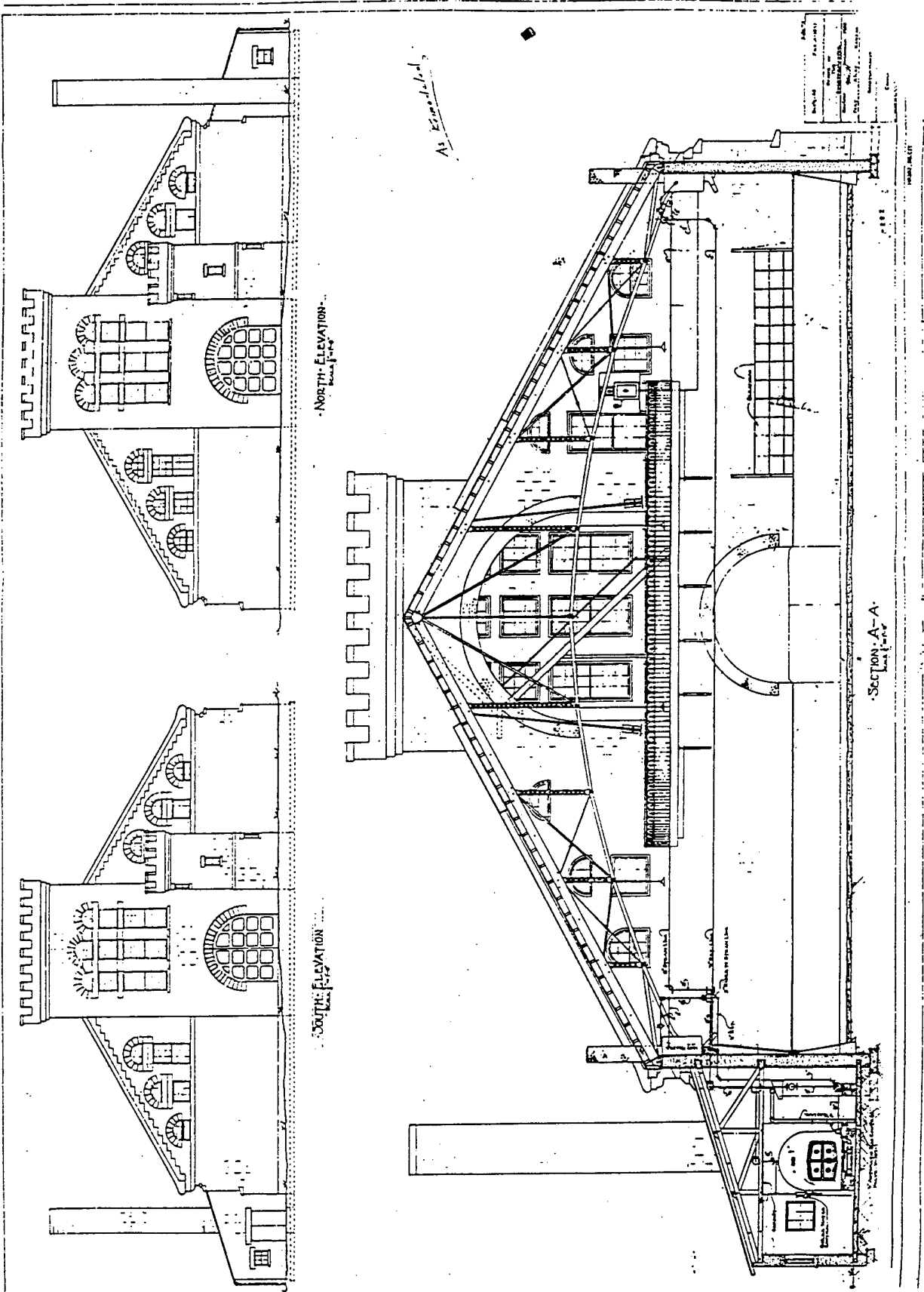

Category: RECREATION/SOCIAL/CULTURAL/RELIGION

Type 7 c: Chapels

Description:

Military chapels usually are non-denominational buildings designed for religious services. Chapels constructed at military installations reflect a variety of architectural expressions. Gothic Revival was the predominant style on Army posts, though neoclassical chapels also were built. With some exceptions, the design of chapels was not standardized until the early 1900s. Until then chapels were individually designed and varied among installations. They are similar in typology to university chapels and community churches of the same eras.

Evolution:

Chapels first appeared as separate buildings on Army installations during the second half of the nineteenth century. Chaplains first worked in an unofficial capacity. In 1838, Congress enacted legislation authorizing seventy Army chaplains. During most of the nineteenth century, the actual number of chaplains fluctuated between fifteen and thirty-six. Chaplains were assigned to posts considered "most destitute of instruction." At many posts, chaplains performed services in barracks or in administration buildings, not in separate chapels.⁵

At posts where chapels were constructed, funding was raised through private subscriptions. At some posts, the post council of administration provided special funds for chapel construction. Though some officers believed that the Quartermaster Department should fund construction, appropriated funds were not used for chapels and private funding remained the primary means of funding chapel construction.⁶

Early military chapels followed the various traditions of American church design. The earliest chapel identified during this study was the Old Cadet Chapel, a stone Greek Revival chapel completed in 1837, at the U.S. Military Academy at West Point. Other early chapels are located at Ft. Riley, Kansas, and Ft. Monroe, Virginia. Ft. Riley's small stone chapel was constructed about 1855. The wood frame, board-and-batten Chapel of the Centurion at Ft. Monroe was completed 1857 and dedicated in 1858. It is similar to published designs for rural churches by Richard Upjohn, an architect noted for his Gothic Revival church architecture.

Chapels became more common on Army posts during the years after the Civil War. Proposed Army construction regulations published in 1861 included estimates for a chapel and depicted a chapel design similar to a company barracks. After the Civil War, Congress authorized the establishment of schools at posts, garrisons, or permanent camps to instruct enlisted men. When

⁵ Herman A. Norton, *Struggling for Recognition: The United States Army Chaplaincy, 1791-1865*, Washington, D.C.: Government Printing Office, 1977, 49; Earl F. Stover, *Up from Handyman: The United States Army Chaplaincy 1865-1920*, Washington, D.C., Government Printing Office, 1977, 32.

⁶ Norton, *Struggling for Recognition*, 51.

no suitable room or buildings were available for educational or religious purposes, the Secretary of War directed the Quartermaster Department to construct them. The Quartermaster Department submitted plans and detailed estimates of cost to the Secretary of War; however, by 1878, few buildings for educational or religious purposes had been constructed. A board of officers convened to implement the policy of providing buildings for educational and religious purposes recommended the use of post funds to construct such buildings and the wider use of Quartermaster appropriations. Consequently, the Quartermaster Department began to construct an increasing number of schools, chapels, reading rooms, and libraries. In some cases, existing buildings were converted to chapels. For example, at Ft. McPherson, Georgia, a building originally constructed as a guardhouse was converted to a chapel in 1893.⁷

Despite the apparent availability of appropriated funds for chapel construction, private funds remained the main source of funding for chapel construction. Construction of Catholic churches on Army posts was funded through private or Church funds. After the construction of the Chapel of the Centurion at Ft. Monroe, the Catholic Church received permission to build a chapel outside of the walls of the fortifications and constructed a simple wood frame church in 1860. After its destruction by fire, the original church was replaced by a more elaborate Gothic Revival stone church in 1903. In 1889, a brick, Gothic Revival church was built at Ft. Leavenworth, Kansas. Chapel construction was often an opportunity for the post and the civilian community to work together to establish strong connections. At Ft. Sam Houston, Texas, a group of community leaders and members of the military garrison formed a committee to raise funds for the construction of a post chapel on land donated by the City of San Antonio. The 1909 chapel was an elaborate, neoclassical building designed by local architect Leo M. J. Dielman.⁸

Chapels offered an opportunity for landmark architecture and sometimes were major examples of high artistic expression. The chapel constructed between 1906 and 1910 at the U.S. Military Academy at West Point is the most striking chapel on an Army installation. This impressive Gothic Revival building was designed by the architectural firm of Cram, Goodhue, and Ferguson as a major element of their new plan for the U.S. Military Academy. The chapel dominates the silhouette of West Point and overlooks the Plain from its prominent location.

The Quartermaster Department issued standardized plans for chapels during the first decade of the twentieth century. Francis B. Wheaton, Advisory Architect in the Office of the Quartermaster, designed plans for a chapel reminiscent of small, English country parish churches.⁹ No examples of this plan were identified during this study, but the 1931 chapel at Walter Reed Medical Center is similar to Wheaton's design.

⁷ War Department, *Regulations Concerning Barracks and Quarters for the Army of the United States, 1860*, Washington, D.C. George W. Bowman, 1861, 4; Risch, *Quartermaster Support of the Army*, 489-490.

⁸ John Paul Graham, et al., *The Architectural Heritage of Fort Monroe: Inventory and Documentation of Historic Structures Undertaken by the Historic American Buildings Survey*, Washington, D.C., Historic American Building Survey/Historic American Engineering Record, National Park Service, Department of the Interior, 1987), 23; *Fort Leavenworth Historic Building Inventory*, MSS, Directorate of Engineering and Housing, Ft. Leavenworth, Kansas, 1983, 5; *National Register of Historic Places Inventory Nomination Form, Post Chapel, Fort Sam Houston*, MSS, National Park Service, National Register of Historic Places, Washington, D.C., 1974.

⁹ NARA, Cartographic Branch, RG 77, Standard Plans of Army Post Buildings 1891-1918, Plan 229.

During the wave of new construction at army posts and air fields during the late 1920s and the 1930s, military chapels often were constructed as part of installation construction programs. Gothic Revival remained an accepted idiom for chapel design; an example was the 1935 chapel at Langley AFB, Virginia. Chapels from the 1930s also often reflected the architectural character of the rest of the installation, usually either Georgian Colonial Revival or Spanish Mission Revival. Chapels built during this era remained individually designed buildings that followed accepted traditions of American church design. Private funds remained a source for chapel construction. For example, the Churchwomen's League for Patriotic Service provided the funds for the construction of the 1933 brick chapel at Plattsburgh Barracks, New York (now Plattsburgh AFB).

During World War II, standardized, temporary, wood frame, chapels were included routinely as part of World War II mobilization cantonments. Since World War II, chapels have been added to most military installations.

Association:

Chapels are associated with the growth of social and cultural amenities provided to military personnel starting in the mid-nineteenth century. Chapels also often represent particular types of architectural design associated with the development of American architecture. Military chapels display a range of architectural expressions: from small, wood frame, Carpenter Gothic chapels, to larger, stone Gothic Revival designs with prominent towers, to neoclassical designs, to period revivals. Since the building of chapels usually fell outside of the normal military channels of funding and design, they often were the work of talented local or, in some cases, national architects, and may represent the work of a master designer. Chapels may display high artistic values in their design and craftsmanship. Chapels should be evaluated for their potential significance as an individual building and as a contributing building in an historic district. Chapels often were located in important locations within the installation plan and may be a key element of an historic district.

Integrity:

To evaluate the integrity of a chapel, the reason for its significance and its period of significance must be identified clearly. If a chapel is significant as an individual building, then it must retain exterior and interior integrity. If it is significant as a contributing element in an historic district, then only the exterior integrity must be evaluated. For a building that is significant for its architecture, the character-defining features of that type or period of architecture must be defined. Important elements of integrity for all chapels of any period or type include exterior form, materials, pattern of openings, types of windows and doors, roof shape, workmanship, and ornament.



1934 Main Chapel at Fort Lewis, WA

Category: RECREATION/SOCIAL/CULTURAL/RELIGION

Type 7 d: Clubs - Officer and Non-Commissioned Officer (NCO)

Description:

Clubs for officers and non-commissioned officers provided dining facilities and social and recreational opportunities. Service clubs generally were one-story buildings detailed in contemporary architectural styles from their period of construction. Officers clubs are often located on prominent sites in or near officer housing areas; non-commissioned officers (NCO) clubs generally have less prominent locations.

Evolution:

Officers clubs evolved from the officers mess and from unofficial organizations of officers. The hierarchical nature of military life required separate living and dining facilities for officers and enlisted personnel. Officers typically ate in their family quarters or in mess rooms within the bachelor officer quarters. Officers were responsible for paying for their own subsistence. Few free-standing officers mess buildings were built during the nineteenth century.

At Ft. Totten at Willets Points, New York, an officers club developed from an informal organization that provided both professional and social activities. In 1869, the post commander had organized a scientific club called the "Essayons Club of the Corps of Engineers." In 1870, Ft. Totten was designated as the Engineers Depot for the East. By 1870, the Essayons Club had its own wood frame building. The club was composed of all officers on duty at the engineer depot and became a professional forum for military engineers. In 1885, the club received official recognition and became the "Engineer School of Application." The club building was renovated to its present appearance in 1887.¹⁰

By the first decade of the twentieth century, post plans depict officers clubs at the Presidio of Monterey, California, and at Ft. Sam Houston, Texas. Officers messes were depicted on 1906 maps of Ft. Sheridan, Illinois, and Ft. McNair, Washington, D.C.¹¹ No standard building plans for officers clubs or messes were located in the Quartermaster Department 1891-1918 standardized plan files. Officers messes and clubs may have been housed in pre-existing buildings originally built for other uses. For example, at Ft. Monroe, Virginia, officers utilized the Flagstaff Bastion of the old fortifications as their club. In at least one instance the Army built a structure specifically for an officers club. At Ft. McNair (formerly Washington Barracks), the officers club was designed by the architectural firm of McKim, Mead and White, which the Army had commissioned to design the Army War College; the Georgian Revival officers club

¹⁰ *National Register of Historic Places Inventory Form, Fort Totten Officers' Club*, MSS, National Park Service, National Register of Historic Places, Washington, D.C., 1984.

¹¹ NARA, Cartographic Branch, RG 92, Records of the Office of the Quartermaster General, Post Plans 1904-1905.

was placed in a prominent location, facing the parade ground, at the end of the officers' housing row.

During World War I, service clubs proliferated, particularly at installations with few recreational outlets off the installation. Both NCO and officers clubs were constructed at Edgewood Arsenal, Maryland, during World War I.

During the 1930s, officers clubs were standard components of installations. In general, the Quartermaster Corps constructed officers clubs in prominent locations near the officers housing area. As the standard of living improved for enlisted personnel, NCO clubs became more common. During the same period, the Army constructed large numbers of NCO family housing quarters for the first time. NCO clubs were smaller buildings than officers clubs with simpler architectural treatment and usually were located in less prominent locations of the installation, near NCO family housing. Ft. Monroe opened an NCO club in 1934. The Army Air Corps originally built two small, one-story enlisted men's clubs in 1931, one near each area of NCO family housing, at the new Randolph Field, Texas. The clubs of this era were constructed in the prevailing architectural styles, usually Georgian Colonial, Spanish Mission, or Tudor Revival, of the installation.

Association:

Service clubs are associated with the growth of social and cultural amenities provided to military personnel during the late nineteenth and twentieth centuries. Service clubs generally became part of the overall military installation planning process during the twentieth century and may be additions to installations established before 1900. Service clubs can be both major and minor building types on installations. These buildings often reflect the military's adaptation of contemporary architectural styles to installation construction. Service clubs may possess individual architectural merit. They also can be contributing elements to an historic district. Service clubs may have either a prominent or less-prominent location in the overall plan of the installation and can be a major architectural element representing the overall architectural character of an installation.

Integrity:

To possess architectural integrity, service clubs should retain most of their design, materials, workmanship, and setting from their periods of significance. Service clubs are among the most altered of pre-1940 buildings and thus, very few retain their original form, due to numerous additions. As installation populations grew far beyond pre-1940 levels, mess and club facilities were expanded to accommodate the increased numbers of personnel. In instances of subsequent additions or renovations, the building still may have integrity if it retains the majority of its design in terms of massing, roof, proportion, pattern of openings, materials, and ornamentation.



1930's Officer Club at Aberdeen Proving Ground, MD

Category: RECREATION/SOCIAL/CULTURAL/RELIGION

Type 7 e: Elementary Schools

Description:

The elementary school building was constructed as a classroom facility for school-age children living on military installations. They followed the typical design of schools of the same era in the civilian community.

Evolution:

After the Civil War, the U.S. Congress provided for the establishment of schools at posts, garrisons, or permanent camps to instruct the enlisted men in "the common English branches of education, and especially in the history of the United States." As the nineteenth century progressed, there also was a growing concern for the education of school-age children living on post, particularly at isolated installations. Rooms in existing buildings were used as classrooms; the chapel often served as a classroom during the week. Children of families living on the post received instruction during the day; enlisted personnel received instruction in basic subjects after their duties were completed. The chaplain often served as the teacher for both the children and the troops.¹²

Not until the twentieth century did the Army start to provide separate buildings to serve as post school houses. In 1907, the Quartermaster Department issued a standard plan for a two-story post school house which included classroom facilities. Another plan was issued in 1913 for construction at Ft. Leavenworth, Kansas.¹³

During the inter-war period, the education of children of families living on the post and the instruction of troops in basic subjects were separated. The training and education of enlisted troops became an integral part of the military; formal education programs were developed and classroom buildings constructed. After the mid-1920s, more families began to live on post as both the size of garrisons and the number of enlisted men allowed to marry increased. Elementary schools for children living on post, though not a standard component of inter-war construction, were built on some installations that had large populations and were isolated from communities with civilian schools. Elementary schools on Army posts during this period generally were designed in period revival styles, either Georgian Revival or Spanish Mission Revival, depending on the region. They are similar to the designs for elementary schools in civilian communities.

Association:

¹² Risch, *Quartermaster Support for the Army*, 489.

¹³ NARA, Cartographic Branch, RG 77, Standard Plans of Army Post Buildings 1891-1918, Plans 187, 322.

Association:

Elementary school buildings are associated with the growth of social and cultural amenities provided to military personnel and the increased emphasis on providing services for the families of Army personnel after the turn of the century. Schools for children living on post grew out of informal arrangements during the nineteenth century; during the 1930s, some installations operated elementary schools similar to those found in civilian communities. Elementary schools are support buildings that may contribute to an historic district, but usually are not individually significant. Elementary schools generally reflect the architectural character of the installation design from the 1930s.

Integrity:

Elementary schools built before 1940 were designed and built for the individual installation. They possess the same character-defining features found in civilian schools of the same period: interior space defined by function -- classrooms, offices, hallways, and auditorium; architectural emphasis on the front facade; small scale; and, period revival designs. The integrity of these buildings should be evaluated in the context of their appearance during the period of significance of the building or of the historic district. To possess architectural integrity, elementary school buildings should retain most of their design, setting, and exterior materials from the period of significance. In cases of subsequent additions or renovations, the building may have integrity if it retains the majority of its design, including the building shape, massing, pattern of openings; materials; workmanship, including architectural details; location; and, setting.

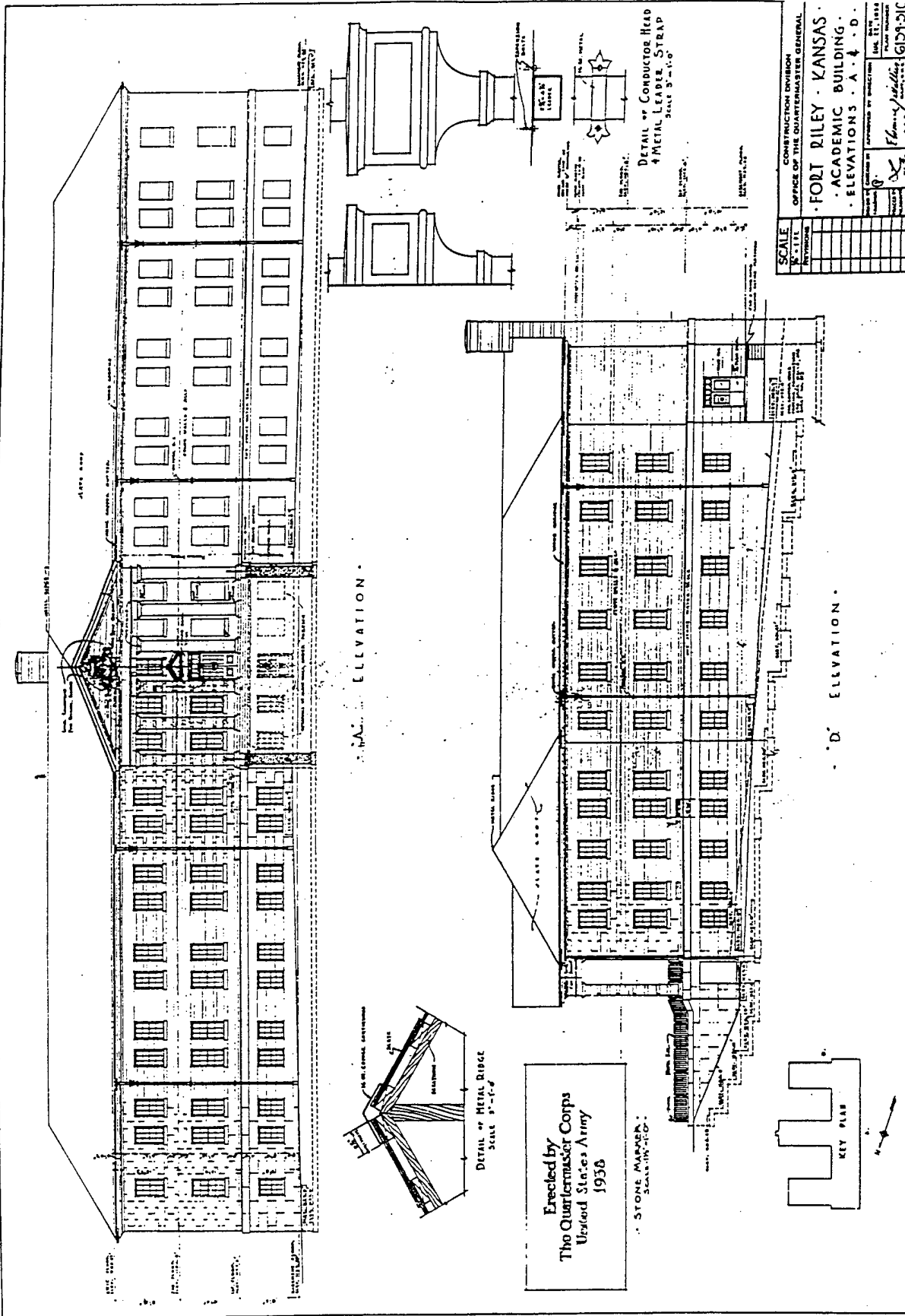

A. ELEVATION

D. ELEVATION

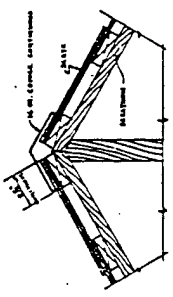

DETAIL of METAL RIDGE
Scale 1/2" = 1'-0"

Erected by
The Quartermaster Corps
United States Army
1938

STONE MARBLE
SUNSHINE

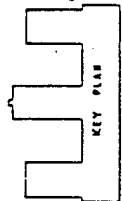

KEY PLAN

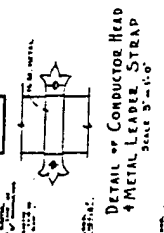

DETAIL of CONDUCTOR HEAD
& METAL LEAD STRAP
SCALE 3/4" = 1'-0"

SCALE	CONSTRUCTION DIVISION	OFFICE OF THE QUARTERMASTER GENERAL	FORT RILEY - KANSAS	ACADEMIC BUILDING	ELEVATIONS - A - D	APPROVED BY DIRECTOR	DATE	DRAWN BY	CHECKED BY
1/4" = 1'-0"	6159-21C								

H0200_13.cit A-21-5

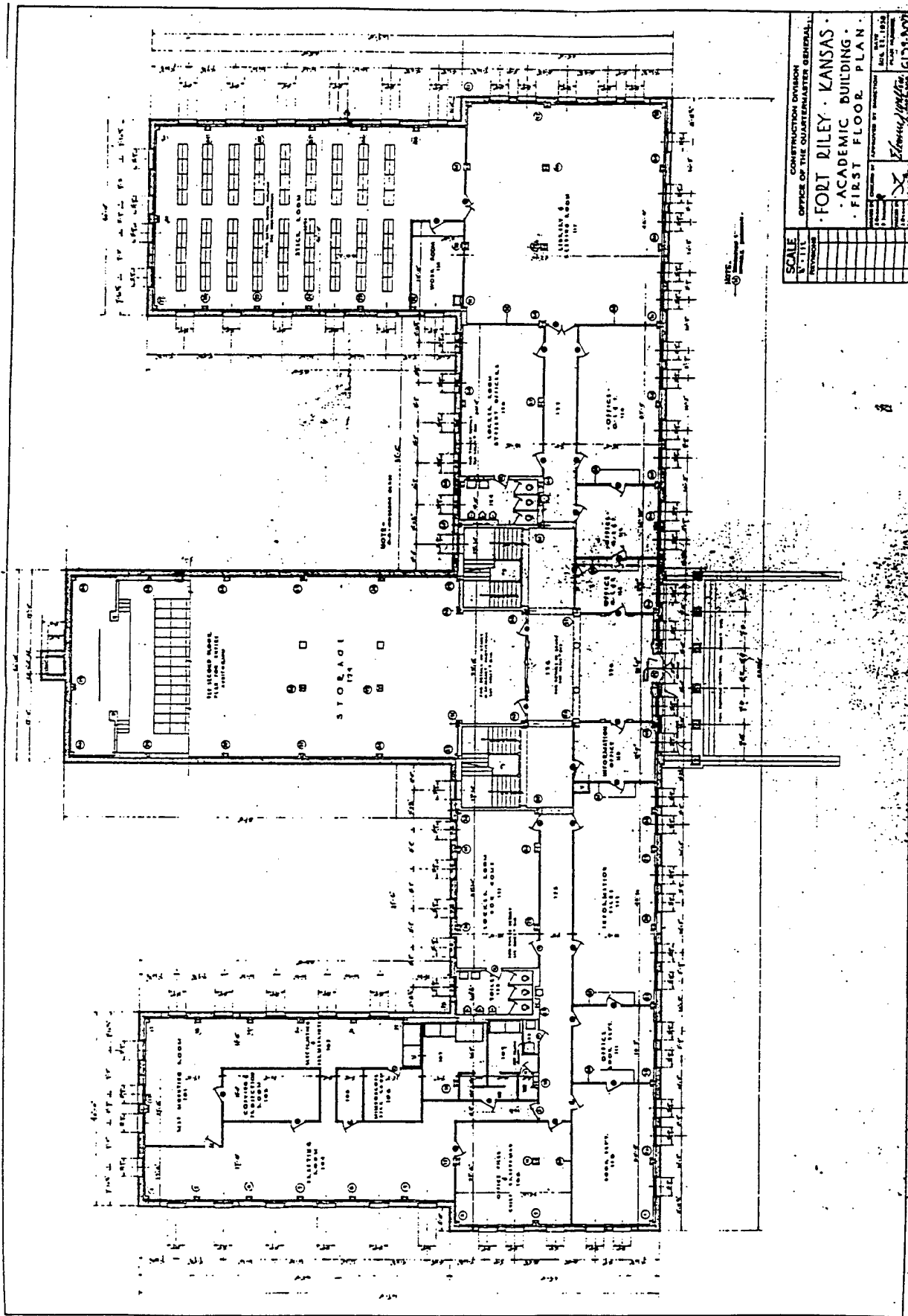

SCALE
 1" = 10'
 ARCHITECT
 CONSTRUCTION DIVISION
 OFFICE OF THE QUARTERMASTER GENERAL
 FORT RILEY, KANSAS
 ACADEMIC BUILDING
 FIRST FLOOR PLAN
 DRAWN BY
 CHECKED BY
 APPROVED BY
 DATE
 6/15/50

100 200-10. 014
 100 200-10. 014

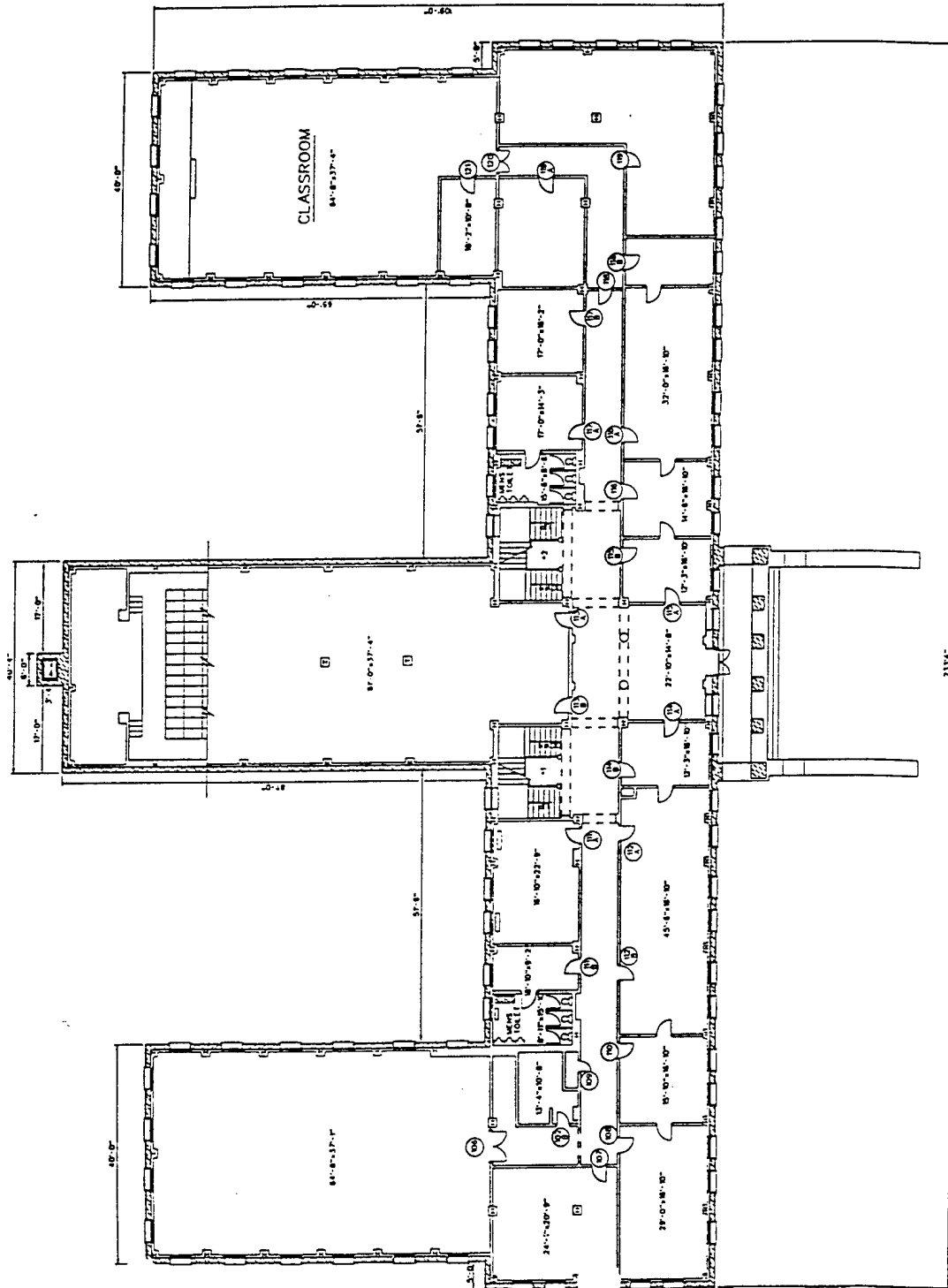

OFFICE OF THE POST ENGINEER					
DATE BY	DESIGNED BY	TRACED BY	SUBMITTED BY	APPROVED BY	PL. OR NUMBER
NOV. 22, 1938	W. J. P.	W. J. P.	W. J. P.	W. J. P.	2135
PATTON HALL BUILDING #201 MILITARY POST					
					DATE BY
					DATE BY

NOV. 22, 1938

Category: RECREATION/SOCIAL/CULTURAL/RELIGION

Type 7 f: Exchange

Description:

The post exchange developed as an officially-sanctioned retail store to sell goods not issued to military personnel by the government. The post exchange is not funded through moneys appropriated for military expenditures. Between the late nineteenth century and 1940, the post exchange was generally a small, one-story building, constructed from a variety of materials. During the 1930s construction era, post exchanges became standard components of Army posts that were integrated into the master plan of installation layout. Their physical appearance often reflected the contemporary design of the installation.

Evolution:

During the nineteenth century, private individuals called sutlers were licensed to sell goods to troops. Sutlers usually were attached to a particular regiment and followed the unit, setting up a tent outside the soldiers' encampment. For permanent Army posts, the sutler built a store where he sold a variety of articles, including canned goods, clothing, and newspapers. In 1866, Congress abolished the office of sutler and mandated the Subsistence Department to furnish troops with items designated as necessary by the Inspectors-General of the Army. The supplies were priced at cost and purchased on credit if needed. Though the office of sutler was abolished, the practice of civilian retail commerce on Army posts was not. Civilian businessmen who performed this function were known as post traders. Post traders were appointed by the Commanding General of the Army.¹⁴

In 1880, officers at Vancouver Barracks, Oregon, conceived the idea of improving the soldiers' morale by opening a "canteen" where soldiers could eat, play games, and relax. As the canteen evolved, it began to stock beer and general merchandise; profits from the sale of these items went into a post morale fund. Gradually, canteens began to displace post traders. Canteens spread slowly throughout the Army during the 1880s and 1890s. By 1903, the Quartermaster Department issued a standardized plan for the post exchange. The first post exchanges incorporated many functions into one building, including a lunch room with kitchen, reading room, school room, assembly hall, and billiard room. In some cases, the post exchange was combined with a gymnasium; combination post exchanges-gymnasiums were built in 1905 at Ft. Monroe, Virginia, and Ft. D.A. Russell, Wyoming.¹⁵

During the 1930s, the Army constructed new installations, particularly air fields, that housed many more troops than the old pre-World War I permanent posts. During the inter-war period,

¹⁴ Michael E. Hucles, *From Haversack to Checkout Counter. A Brief History of the Army Commissary System*, Fort Lee, Virginia, U.S. Army Troop Support Agency, 62, 37, 54.

¹⁵ Edward Coffman, *The Old Army*, New York, Oxford University Press, 1986, 358-361; NARA, Cartographic Branch, RG 77, Standard Plans of Army Post Buildings 1891-1918, Plans 156, 155, and 154.

the Army also provided more recreational and social amenities to military personnel at installations. Separate buildings exclusively for use as post exchanges became typical features of the new installations built during the inter-war period. The Quartermaster Corps developed a standardized plan for post exchanges: a one-story building with two projecting wings connected by a colonnade. The detailing of post exchanges reflected the overall architectural character of the installation, generally Georgian Colonial Revival or Spanish Colonial Revival.

Association:

Exchanges are associated with the growth of social and cultural amenities provided to military personnel during the late nineteenth and early to mid-twentieth centuries. Exchanges did not become typical features of Army posts until after 1905. Exchanges usually are minor support buildings that do not possess individual significance, but can contribute to an installation historic district. They can represent the institutional development and the architectural character of the installation.

Integrity:

Pre-1940 exchanges that have continued to serve in that function are among the most heavily altered of installation buildings due to the vastly increased size of the exchange retail facilities. Early exchanges that were adapted for another use are more likely to retain their original design features. To possess architectural integrity, an exchange should retain most of its design features and exterior materials from the district's period of significance. The building may have integrity if it retains the majority of its design, including form, pattern of openings, porches, and arcades, materials, workmanship, and setting.



1905 Post Exchange at (Fort D.A. Russell)

Category: RECREATION/SOCIAL/CULTURAL/RELIGION

Type 7 g: Theaters

Description:

Movie theaters usually were one-story, rectangular, front-gabled buildings with long, unfenestrated side walls. The focus of the design was the front facade and entrance, which often featured a projecting vestibule or display marquee. Movie theaters on military installations did not display the ornate ornament of the civilian movie palaces of the same era. Most military movie theaters built for that purpose were brick buildings with simplified Georgian Colonial Revival or Spanish Mission Revival details.

Evolution:

The Army began to build movie theaters at its installations as the movie industry evolved and became a popular form of entertainment. At first, older buildings were adapted for use as movie theaters. During the wave of new construction of the late 1920s and the 1930s, movie theaters became typical features of Army installations. Theaters were added to older installations and were standard components of new post plans. The construction of theaters reflected the Army's increasing concern with the well-being and morale of military personnel. Theaters were located within the heart of the cantonment area, near the barracks. The majority of theaters were constructed from similar Quartermaster standardized plans: gable-roofed, rectangular buildings, with the entrance on the gable end, sometimes with a projecting vestibule that housed the lobby and ticket office. The same basic plan was executed in both Georgian Colonial and Spanish Colonial Revival designs. A few individually-designed theaters also were built. The theater at Randolph AFB, Texas, was incorporated into the central administration building, while the theater at Ft. Sam Houston, Texas, is a prominent building with a corner tower that faces the central parade ground.

Association:

Theaters are associated with the growth of social and cultural amenities provided to military personnel during the late 1920s and 1930s and with the appearance of the movie industry. During the 1930s, movie theaters and athletic facilities provided the major sources of recreation and entertainment on installations. Often the theater reflects the military's adaptation of contemporary architectural styles to installation construction. They generally do not possess individual historic significance, but can be contributing buildings in an historic district.

Integrity:

To possess integrity, theaters should retain most of their architectural ornamentation, design features, and exterior materials from their period of construction. Buildings originally built for other purposes and adapted for use as movie theaters may still possess integrity; the modifications may have acquired their own significance. Character-defining features of movie

theaters can include the overall shape of the building, ticket and lobby vestibules, blank side and rear facades, marquees, and ornament on the front facade. Theaters are not generally used currently for their original purpose and have been modified for new uses, including museums, storage facilities, or even incorporated into a hospital complex. The building may have integrity if it retains the majority of its design, materials, workmanship, and location.



1930 s Main Theater at Fort Sam Houston, TX

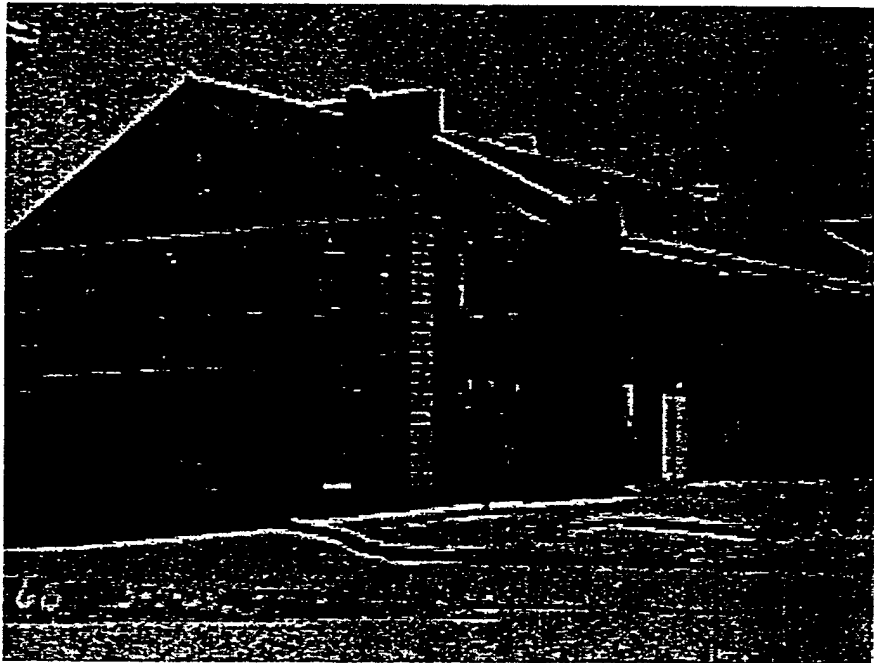

1934 Post Theater at Fort Lewis, WA

Category: RESEARCH AND DEVELOPMENT

Type 8 a: Laboratories/ Research and Testing Facilities

Description:

Laboratories and research buildings are specialized facilities constructed for specific purposes to research, test, or monitor a particular technology. Laboratories and research facilities usually were one-of-a-kind buildings unless that function was replicated at another installation. Buildings built for research functions were constructed of permanent materials and were of functional design.

Evolution:

The Army developed laboratories to support production facilities at arsenals, to assist experimentation with production processes, and to test production results. An early powder laboratory was constructed at Watervliet Arsenal, New York, in 1840. During the nineteenth century, the Army constructed few facilities specifically for testing or research. After the Army established its first smokeless powder plant at Picatinny Arsenal, New Jersey, in 1908, Picatinny became an important center for ammunition research. Many of the earliest buildings at Picatinny were destroyed in the 1926 explosion at the neighboring Navy Ammunition Depot at Lake Denmark. The installation was rebuilt during the late 1920s and the 1930s with a specific area, set apart from the production facilities, for administration and research buildings built of permanent brick construction.

As the Army expanded its interest in the application of various technologies to warfare, it established laboratories to promote and test direct applications of those various technologies. After the turn of the century, the Signal Corps constructed laboratories to conduct research in the fields of photography and communications. Photographic laboratories were constructed at posts where the Signal Corps experimented with the use of photography, particularly for reconnaissance activities. Fort Benning has such a hangar with a photograph laboratory. During the 1920s and 1930s, the Army constructed many air fields; photographic laboratories were common components of these air fields as the military experimented with aerial photographic reconnaissance. The standard photographic laboratories were one-story, brick buildings without architectural ornament.

The Signal Corps also experimented with communications technology. During World War I, it established a radio laboratory at Camp Monmouth, New Jersey, in temporary buildings. In 1935, the Signal Corps constructed a permanent communications laboratory at Ft. Monmouth. Designed by Rodgers and Poor, architects from New York City, the laboratory is a two-story, L-shaped building consisting of two parts: an administration and laboratory section and a shop section at the rear.

During the late nineteenth and the twentieth centuries, the Army developed proving grounds to test weapons and ammunition. The Army established Sandy Hook Proving Ground in New

Jersey in 1874. The Army established Aberdeen Proving Ground, Maryland, in 1918 when it outgrew the Sandy Hook installation. At Aberdeen, the Army constructed specialized permanent buildings to prepare proofing tests, monitor firing methods, and calculate projectile trajectories and velocity. These utilitarian buildings were constructed to shelter and protect personnel performing proof testing.

In general, between 1800 and 1940, the Army required a limited number of laboratory and specialized test facilities. In the years preceding and during World War II, the number of laboratories and test facilities expanded to meet the increased schedules of production, proofing, testing, and technological advances.

Army Air Corps

The Army Air Corps developed research and testing facilities in response to technological advances in aircraft. Langley AFB, Virginia, originally was established in 1917 as a joint National Advisory Committee for Aeronautics (NACA), Army, and Navy aviation experimentation center. In 1919, the Army Aeronautical Laboratory opened. Other specialized research facilities constructed at Langley AFB included wind tunnels constructed in 1921 and 1923 and an NACA laboratory. The construction at Langley was designed specifically for the facility by architect Albert Kahn.

The Army expanded its aviation experimental facilities after World War I. The Army Air Corps moved its testing and experimental activities to temporary facilities at McCook Field, Ohio, in 1918. In 1927, Wright Field, now Wright-Patterson AFB, Ohio, was established as the Army's primary experimental aircraft research facility. During the 1920s and 1930s, the Army Air Corps constructed a variety of individual laboratory and test facilities at Wright Field. These facilities included a radio laboratory to improve ground to air communication, a materials laboratory to test new aircraft materials, an armament laboratory to test the effects of ammunition discharges on aircraft, a propeller laboratory to test the speed and strength of aircraft propellers, and a wind tunnel to test airplane designs. All of these buildings were utilitarian designs engineered to meet special needs. These buildings often represented the precepts of contemporary industrial architecture: use of concrete and steel, and an emphasis on functional designs.¹

Association:

Research and development buildings, including laboratories and test facilities, are associated with themes of technology, transportation, and communications. These facilities are associated with the development of new technologies, the military application of technology, and scientific research. They may be associated with specific technological breakthroughs or with the general development of military technology over time. Research and development facilities often were buildings designed to meet specific research or testing -purposes. In other cases, the buildings associated with research and development may have been simply structural shells or office

¹ Lois E. Walker and Shelby E. Wickam, *From Huffman Prairie to the Moon*, Washington, DC, Government Printing Office, 1984, 122-126.

buildings that housed research activities, without any relationship between the building design and the activity within the building. Research facilities may have testing ranges and firing ranges that also were associated with important weapons development; these areas should be considered for inclusion within historic districts along with associated buildings and structures.

Research and testing facilities may possess historic significance and meet the criteria for listing on the National Register of Historic Places, either as individual buildings or, as districts. Research and development facilities may represent important elements in a research complex or production facility and contribute to an historic district.

Integrity:

To possess the integrity necessary to convey significance, research and development facilities should retain most of their original design, materials, workmanship, and setting from their periods of significance. Character-defining features of research and development facilities may include their overall shape, their relationship to other buildings in the complex, materials, features specific to the research conducted at the facility, and overall pattern of exterior windows and doors. Buildings that housed research and development activities often were altered to accommodate new research missions or technological advances. Typical alterations include replacement of original testing equipment, alterations to window and door openings, and enlargement of interior -space through building additions. In cases of subsequent additions or renovations, the building may have integrity if it retains the majority of its character-defining features, particularly any features specific to the research or testing activity, its setting, basic form, materials, and pattern of openings.

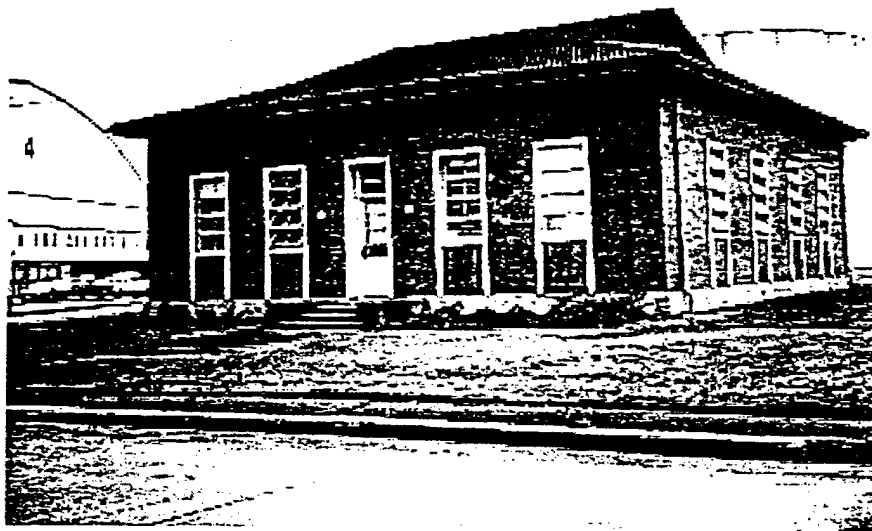

1939 Photographic Laboratory Building at McChord AFB, WA

Category: RESIDENTIAL

Type 9 a-1: Institutional Housing: Bachelor Officers Quarters (BOQs)/Nurses Quarters

Description:

The military constructed bachelor officers quarters (BOQs) to house unmarried officers or those officers stationed at an installation without their families. Bachelor officers quarters usually were rectangular, two-story structures that contained living quarters and mess facilities for officers. Bachelor officers quarters were standard components of Army permanent cantonments. They usually were located near the parade ground or near the officer family housing. During the last quarter of the nineteenth century, the military designed bachelor officers quarters using Victorian architectural motifs. During the early twentieth century, bachelor officers quarters were constructed to reflect the Georgian Revival and the Spanish Colonial Revival styles. The evolution of quarters design illustrates the military's interest in and adaptation of contemporary civilian architectural trends to the military's construction program.

Evolution:

The Army has the longest history of providing housing for military personnel because of its history of maintaining permanent garrisons. The strict hierarchical nature of rank required separate quarters for officers and enlisted men. During the early nineteenth century, many officers were either unmarried or lived without their families on posts, due to harsh conditions. Freestanding family housing was provided for the commander, but not for most of the other officers. The early officers housing resembled small barracks, but contained private quarters for each officer. Examples of this type of housing survive at Carlisle Barracks, Pennsylvania, and Ft. Monroe, Virginia. The Carlisle Barracks officers housing, built during the 1830s and rebuilt after the Civil War, was a two-story stone building with a two-story verandah that served as exterior corridors with entries into each room. At Ft. Monroe, two sets of quarters known as the "Tuilleries," built in 1823, originally housed eight officers each; these officers were allotted a bedroom and sitting room.

Bachelor officers quarters evolved as a distinct building on Army posts after the Army began to construct more duplex and single-family officers quarters. When the Army consolidated its troops into larger, permanent posts during the 1880s and 1890s, the Army built rows of officers family housing and usually one bachelor officers quarters at each permanent post. In 1891, the Quartermaster Department issued a standardized plan for a BOQ. The typical BOQ contained sleeping rooms, sitting rooms, dining room, reading room, kitchen, and rooms for recreation including billiards and cards. Quartermaster plans illustrate the standard plan ornamented with Victorian decoration.¹ During the first decade of the twentieth century, the Quartermaster adapted the Colonial Revival style to BOQs, as it did with other building types.

¹ National Archives and Records Administration, Cartographic Branch, Record Group 77, Standard Plans of Army Post Buildings, 1891-1918, P.I. NM-1 9, Entry 411, Plan 25.

Bachelor officers quarters constructed during the 1930s reflected the prevailing architectural styles used by the Quartermaster Corps: the Georgian Colonial Revival and the Spanish/Mission Colonial Revival styles. At a few installations, BOQs were designed in special regional architectural styles, such as the French Provincial Colonial styles at Barksdale AFB, Louisiana, Maxwell AFB, Alabama, or Ft. Benning, Georgia.

Association:

Bachelor officers quarters are associated with the evolution of living standards for military personnel and with the mission of the installation personnel who were housed in the quarters. The buildings reflect the history and status of the military at the time of their construction. The design of bachelor officers quarters often reflects the influence of civilian architecture on military construction and the military's self-perception of its image and presence. Bachelor officers quarters usually are part of a cantonment or a housing area and can be contributing elements in an historic district. Bachelor officers quarters usually were built as part of a larger construction program of installation buildings with similar architecture.

Integrity:

To possess integrity, bachelor officers quarters should retain their setting and location, and the majority of their design, materials, workmanship, association, and feeling from their period of significance. Buildings originally built as bachelor officers quarters now often serve as visiting officers quarters or as office buildings. In some case, porches have been removed or enclosed; window and door openings, modified. In cases of subsequent additions or renovations, bachelor officer quarters may possess integrity if they retain the majority of their shape, massing, materials, pattern of openings, and architectural features. Additions subsequent to the date of construction may have acquired their own significance and do not necessarily detract from the integrity of building if they were added during the building or historic districts' period of significance.



1934 Bachelor Officers Quarters at Fort Lewis, WA

SCHEDULE OF QUARTERS.

Length of building bents.	No. of building bents.	Number of Officers			Total.
		2 Officers to a bent.	Bent Officer.	Comdr.	
63'	9	3	6	1	7
70'	10	4	8	1	9
77'	11	5	10	1	11
84'	12	6	12	1	13
91'	13	7	14	1	15
98'	14	8	16	1	17
103'	15	9	18	1	19
112'	16	10	20	1	21

NOTE:—

For each 2 additional officers add one 7'-0" bent, keeping the hall bent centrally located. One officer to each room marked "Officer."

OFFICERS' QUARTERS.
LARGE.

Scale in Feet.
0 5 10

TEMPORARY BUILDINGS.
FOR
MOBILIZATION CAMPS.

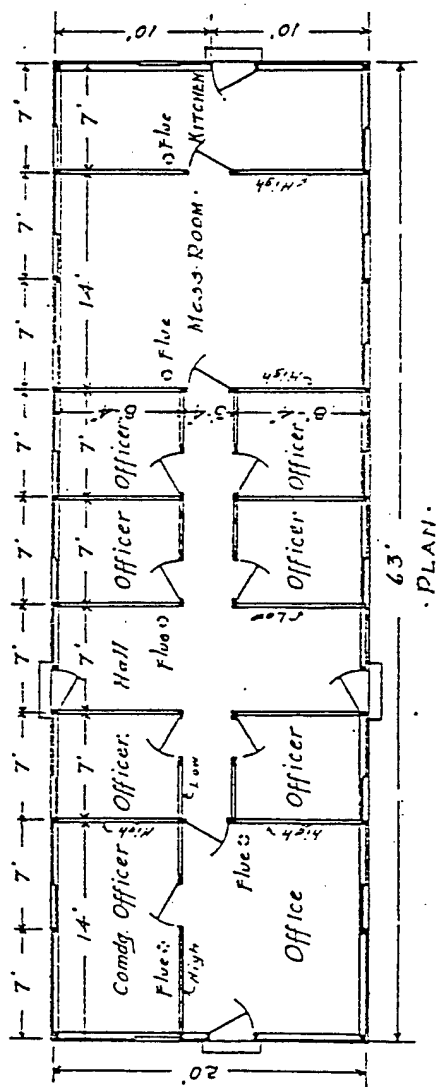
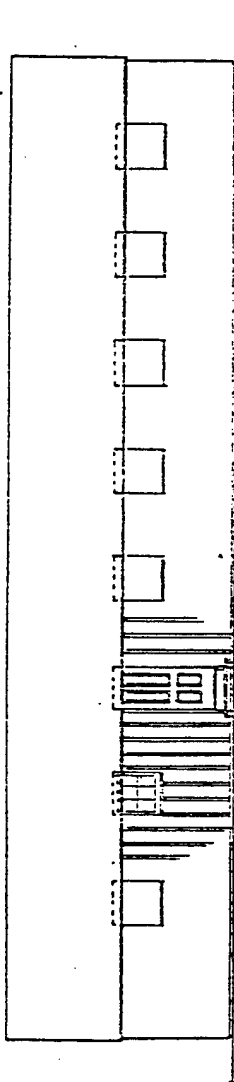
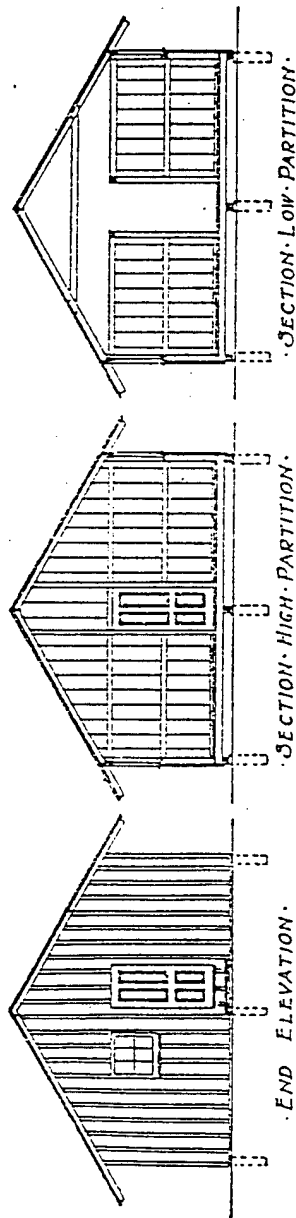

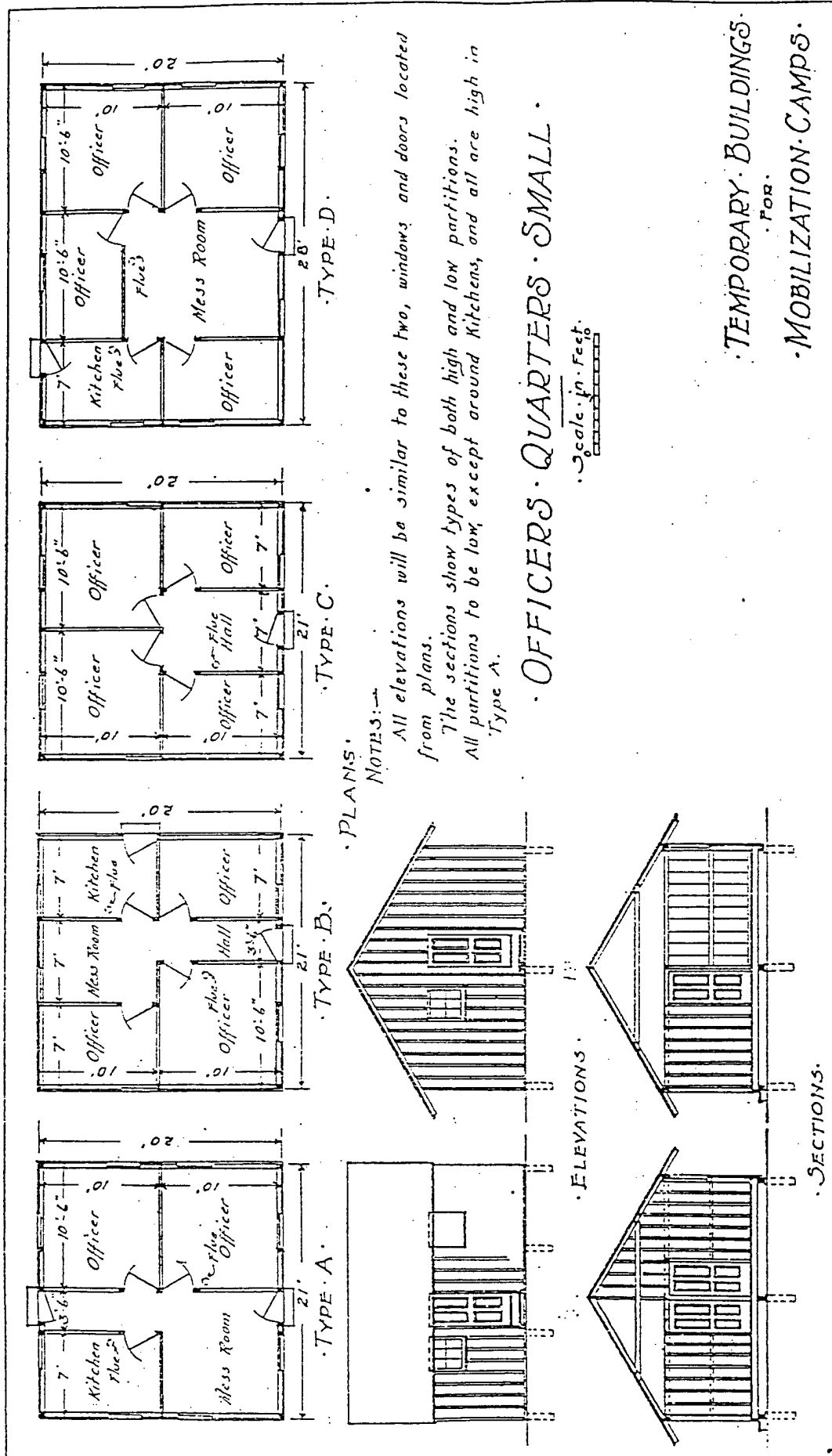

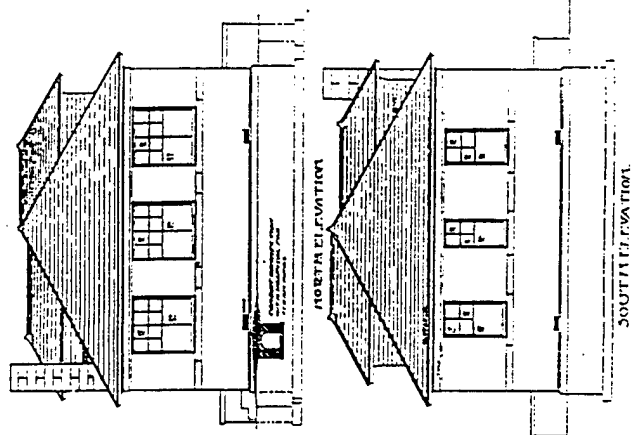

LABORATORY BUILDING
FOR THE
VETERINARY HOSPITAL,
FORT DILL, KAN.

OFFICE OF
CONSTRUCTIVE QUANTIFICATION
PROJECT NO. 7
1700 S. W. 10th St.
SPECTOR
ARCHITECTS
1111
NO. 278 01.011

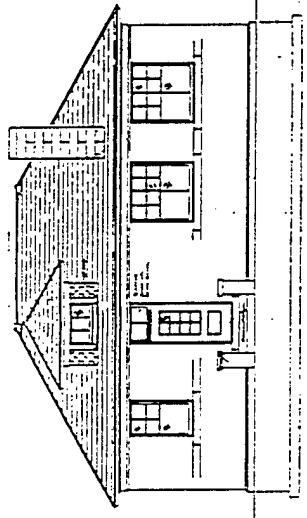

EAST ELEVATION

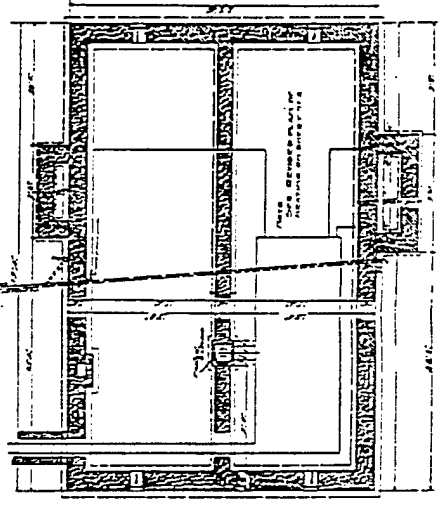

FOUNDATION PLAN

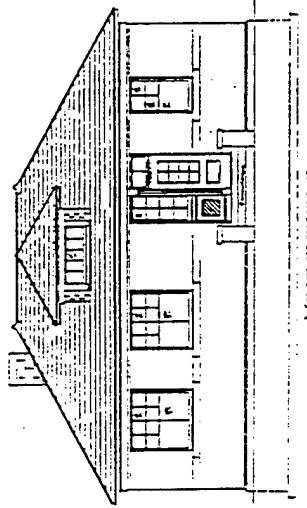

WEST ELEVATION

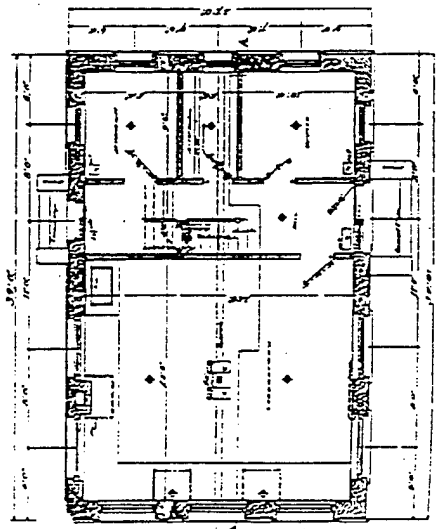

FLOOR PLAN

SCALE 1/8" = 1'-0"

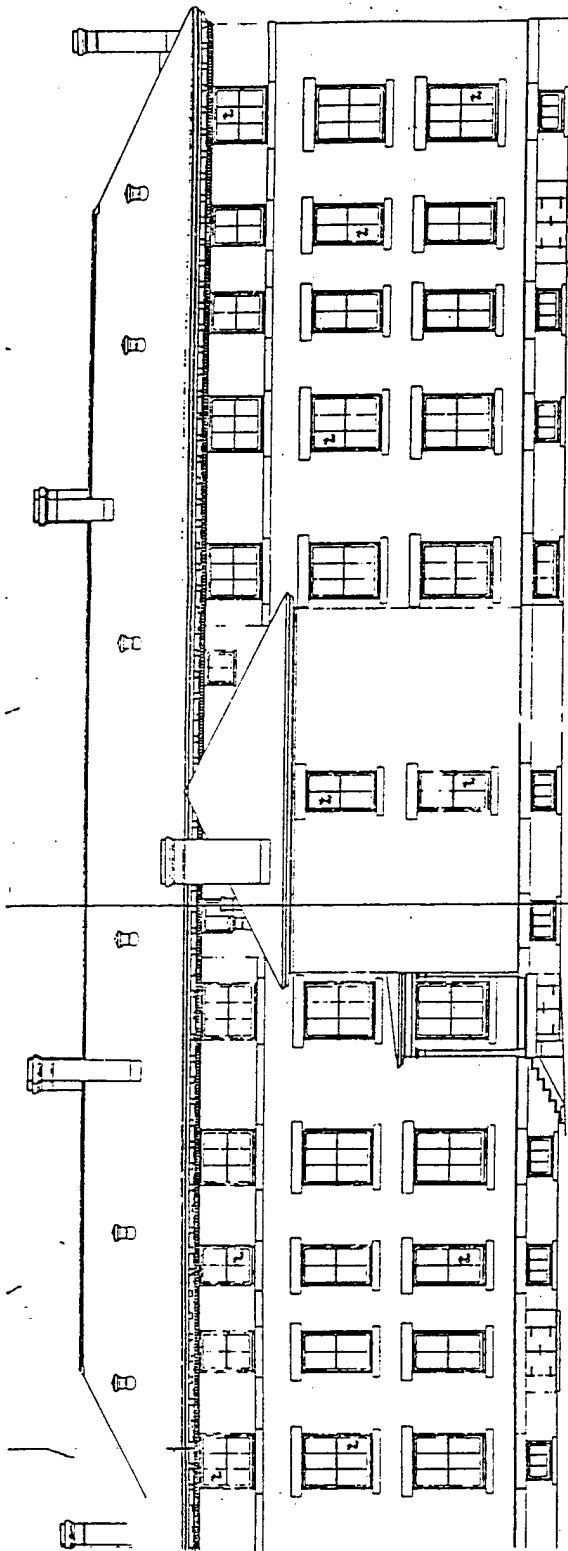

REAR ELEVATION -
SCALE 1/4" = 1'-0"

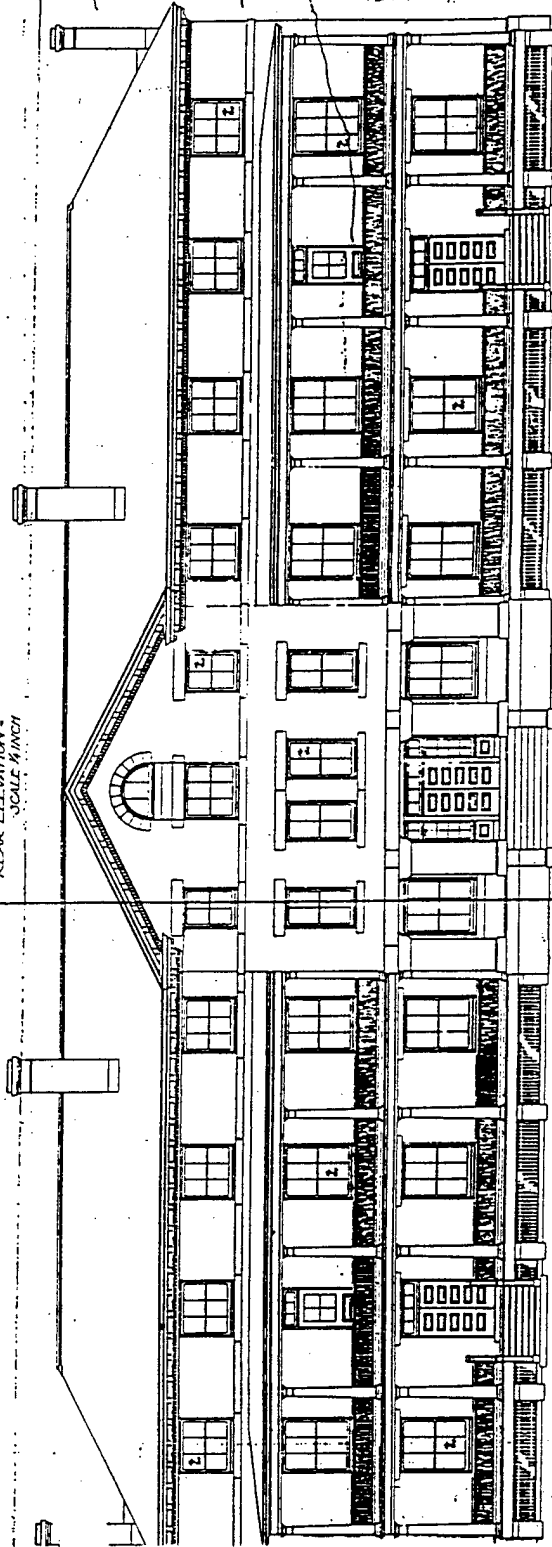

FRONT ELEVATION -
SCALE 1/4" = 1'-0"

561#
SHEET NO. 152 - 7 SHEETS
BACHELOR OFFICERS' QUARTERS
D.M.C.O. # FEB 1941

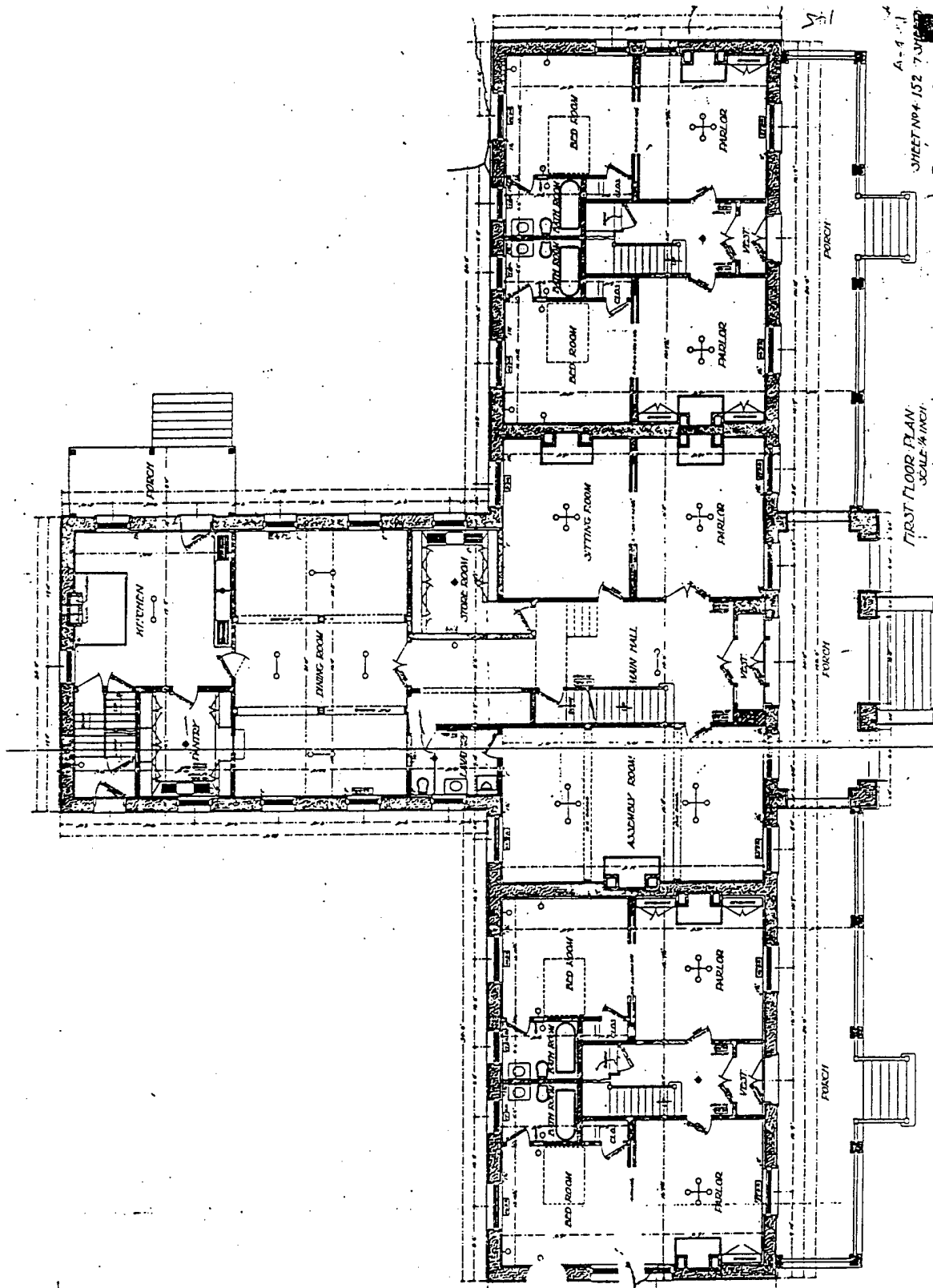

A-4
 SHEET NO. 152 7 3/4
 BACHELOR OFFICE
 1/8" = 1'-0"

FIRST FLOOR PLAN
 SCALE: 1/8" = 1'-0"

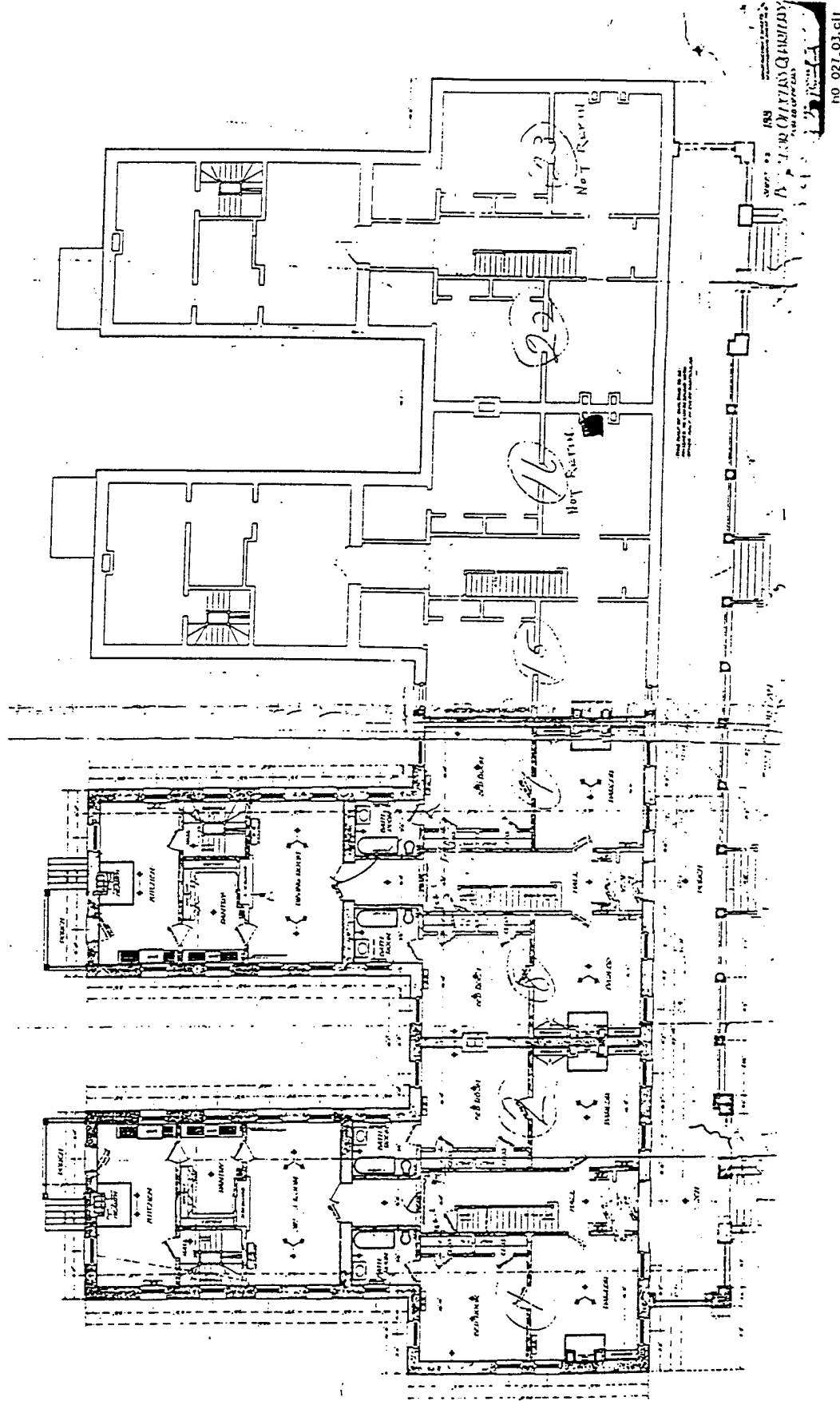

Category: RESIDENTIAL

Type 9 a-2: Institutional Housing: Barracks/Dormitories/Civilian Housing

Description:

The military constructed barracks to house units of enlisted personnel. Barracks are found on all installations where permanent military enlisted personnel resided. Barracks are located in prominent sites, generally in groups facing the parade ground or drill field. Barracks were usually one- to three-story, rectangular buildings, with the primary entrance on the wider elevation. Verandahs were a common feature until the 1930s.

Permanent barracks are a major building type on many installations. Their architecture reflects their period of construction. Barracks exhibited utilitarian designs for most of the nineteenth century; however, during the last quarter of the nineteenth century, the military designed barracks using Victorian architectural motifs. In subsequent years, various period revival styles of architecture were employed in barracks design. The size of the military unit originally intended to reside in the barracks determined the building size. The average size of barracks and dormitories increased over time, from small buildings that housed a dozen men, to buildings that housed hundreds; the number of barracks also increased, reflecting the growing size of the standing military.

Evolution:

The Army constructed few permanent barracks before the Civil War due to the small number of permanent garrisons. Most early-nineteenth century Army posts were either coastal fortifications or temporary frontier garrisons. The troops stationed at the masonry coastal forts of the Third System (1814-1861) were housed in the damp, stone casements of the fortifications, eliminating the need for separate barracks buildings. In a few instances, the Army built permanent garrisons that required barracks. The officers quarters at Cadisle Barracks, Pennsylvania (constructed ca. 1838; burned; rebuilt 1863-1864), typifies the appearance of these early buildings: a narrow, rectangular, two-story, unornamented brick building with a two-story verandah along the front facade. The Army also constructed permanent barracks at Plattsburgh Barracks, New York, in 1838; two, two-story, rectangular, stone buildings with verandahs were built. Buildings of this type were constructed for both enlisted and officer housing.

Most western forts had temporary barracks constructed by troop labor from materials at hand. The Army's mid nineteenth-century policy of establishing and abandoning western posts as needed inhibited the construction of permanent barracks. The typical barracks housed one company of men and contained sleeping quarters, a kitchen, and a mess room; it usually was a one-story, narrow, rectangular building with a porch. A barracks design of this type appeared in the unofficial 1860 Army regulations and is exemplified by examples of barracks identified at

early frontier posts constructed before and after the Civil War.² The basic building type used for barracks easily was adapted for use as a headquarters building or hospital. The 1870 headquarters building at Ft. Sill, Oklahoma, is an example of the basic barracks design adapted for use as the post headquarters.

During the late nineteenth century, the U.S. Army had the reputation for being the best fed, but worst housed Army in the world.³ Efforts to improve living accommodations began after the Civil War, but were limited by budgetary constraints. In 1872, Quartermaster General Montgomery C. Meigs issued standardized plans for a one-company barracks.⁴ The plan depicted a two-story building: the first floor contained day room, library, clothes washroom, kitchen, mess room, and offices; the second floor, sleeping quarters. Meigs' plan offered better accommodations than in the past, as the Army tried to make quarters, reading rooms, and mess rooms more attractive to the soldier than the sutler's shop and the groggery.⁵

During the 1880s and 1890s, the Army consolidated its troops into larger, permanent posts. The Army constructed its new posts with more attention to planning and to contemporary architectural detailing. The barracks, traditionally located along the edge of the central parade ground, became important elements in the installation plan and often were impressive buildings that defined the architectural character of the installation. During this era, the Army built larger, two-company barracks. They typically had a central block flanked by wings with two-tiered porches. Porches served as corridors and provided ventilation. A second form of two-company barracks was created through connecting two T-shaped, one-company barracks to form an H-shaped building. On installations that served more than one branch of the Army, the barracks were designated as cavalry, artillery, or infantry barracks.

During the late nineteenth and early twentieth centuries, the two-company barrack remained the typical barracks design. Only in a few instances did the Army experiment with larger barracks. Often the Constructing Quartermaster developed the plan for larger barracks by incorporating the several one-company barracks plans under one roof, with partitions separating the company quarters. For example, the Army constructed multiple-company barracks at Ft. Crook, Nebraska, and at Ft. Sam Houston, Texas. Ft. Monroe, Virginia, also had a barracks, since demolished, with a central block and long wings that were divided into company units by interior partitions.

The Army adapted architectural fashions to the basic form of the barracks, depending on the popular fashion of the era. During the 1880s and 1890s, the detailing of barracks incorporated simplified versions of features from contemporary architectural styles, such as the Romanesque and Queen Anne. Between 1900 and 1917, the Army applied Colonial Revival architectural

² War Department, *Regulations Concerning Barracks and Quarters for the Army of the United States, 1860*, Washington, D.C., George W. Bowman, 1861, 2.

³ War Department, Surgeon General's Office, *A Report on Barracks and Hospitals with Descriptions of Military Posts (Circular 4)*, Washington, D.C.: Government Printing Office, 1870, xxxiii.

⁴ War Department, *Annual Report of the Quartermaster-General*, Washington, D.C.: Government Printing Office, 1872, plate 3.

⁵ Erna Risch, *Quartermaster Support of the Army: A History of the Corps 1775-1939*, Washington, D.C., Government Printing Office, 1962. Reprinted 1989, 484-485.

motifs to the basic barracks designs of the previous century. In 1911, the Quartermaster Department issued barracks plans using Spanish Colonial Revival motifs; these were built at the Presidio of San Francisco, California, Ft. Sill, Oklahoma, and Ft. Missoula, Montana.⁶

During the Spanish-American War, the Army established a series of encampments across the country to hold troops waiting for transport to Cuba. The hastily constructed tent camps lacked adequate sanitation facilities and fostered the spread of disease among the troops. The Army, determined not to repeat that disastrous experience, developed standardized plans for mobilization camps. In 1914, the Construction Division of the Quartermaster Corps produced a set of drawings for mobilization camp buildings, usually called the 600 series of drawings. The plans depicted one-story, rectangular, light-weight wood frame, barracks based on 20 ft. by 7 ft. modules. The vast number of troops mobilized during World War I overwhelmed the existing supply of Army housing, and the Construction Division put the 600 series drawings to use in the construction of large training camps.⁷

After World War I, military spending slowed dramatically. Thousands of troops continued to live in World War I temporary barracks, which were deteriorating rapidly. Public Law 45, enacted in 1926, authorized the War Department to sell excess property and to use the funds to improve military posts. The War Department singled out barracks as one of the primary building types to receive construction funds. The law was enacted primarily to improve living and medical conditions for enlisted personnel. The Construction Service of the Quartermaster Corps designed the new installations constructed under this act as cohesive facilities; the buildings were placed in ordered relationships within a master plan and shared a unifying architectural treatment. Barracks buildings were a major element within the installation plans and were located in distinct enlisted housing areas.

Barracks constructed during the 1930s reflected the prevailing architectural styles used by the Quartermaster Corps: the Georgian Colonial Revival and the Spanish or Mission Colonial Revival styles. At a few installations, barracks were designed in special regional architectural styles, such as the French Provincial Colonial at Barksdale AFB, Louisiana. The standard barracks design remained a two- or three-story, rectangular building, but was larger than ever before. Between 1928 and 1930, the Army constructed its first regimental barracks, designed by the architectural firm of McKim, Mead, and White, at Governors Island, New York. Other equally large, and larger barracks were built later at Ft. Benning, Georgia, and McChord AFB, near Tacoma, Washington.

Barracks design during the 1930s was not as standardized as officer housing; the basic form was modified to suit the needs of particular installations. One universal design change, however, was the elimination of porches along front facades. This left the main front facade as a flat surface; architectural ornamentation such as stone surrounds around doorways, corner quoins, and cornice moldings relieved the blank facades. Porches were incorporated into the rear of the buildings.

⁶ NARA, Cartographic Branch, RG 77, Standard Plans of Army Post Buildings, 1891 - 1918, Plans 257, 298.

⁷ John S. Garner, *World War II Temporary Military Buildings*, Champaign, Illinois: U.S. Army Construction Engineering Research Laboratory, 1993, 22-25.

The Army also constructed barracks for specialized troops. The most widespread specialized barracks was the band barracks. The band barracks housed a fewer number of men and included music practice rooms and special storage rooms for musical instruments. The band barracks at the infantry Post at Ft. Sam Houston, Texas, included a tower at its gable end; musicians played from the roof of the tower. Between 1880 and 1890, the Army constructed band barracks at many Army installations for regimental and post bands. The Army did not build band barracks during the 1930s construction era.

In addition to band barracks, the Army sometimes constructed barracks for specific Army detachments. The Quartermaster Department might have a separate barracks for its own personnel, near the Quartermaster warehouse area; barracks for medical corps soldiers sometimes were located near the hospital. These specialized barracks were constructed only at large posts, and typically were smaller than standard troop barracks.

The Army, upon occasion, constructed barrack-type housing for civilian employees. The Army provided civilian housing only at isolated posts where no local accommodations were available for needed civilian employees.

Association:

Barracks are a major building type on many military installations. They provided housing for enlisted personnel and are associated with the evolution of living standards for military personnel. The construction of barracks directly reflects the chronological history and status of the military during their period of construction. Barracks are integral components of Army posts and airfields and illustrate the growth in the size of permanent garrisons. Barracks design often reflects the influence of civilian architecture and the military's self-perception.

Barracks buildings are often major elements in an installation plan that establish the character of an area and define the edge of a significant open space, such as a parade ground or drill field. Barracks may possess individual architectural significance because of their design or their ability to represent a type of construction. In many cases, barracks will be major contributing elements to an installation historic district.

Integrity:

To possess integrity, barracks should retain most of their overall exterior form, architectural ornamentation, and construction materials from their periods of significance. Many pre-1940 barracks have been converted to office use. Porches may have been removed or enclosed; window, door, and roof materials often have been modified. Where subsequent additions or renovations have occurred, barracks still may have integrity if they retain the majority of their character-defining features, including setting, overall shape, pattern of openings, materials, and architectural details. In many cases, even with major modification, a barracks complex will contribute to the character of an historic district.



1938-40 Barracks at Fort Sill, OK



1912 Infantry Barracks at (Fort D.A. Russell) F.E. Warren AFB, Wyoming

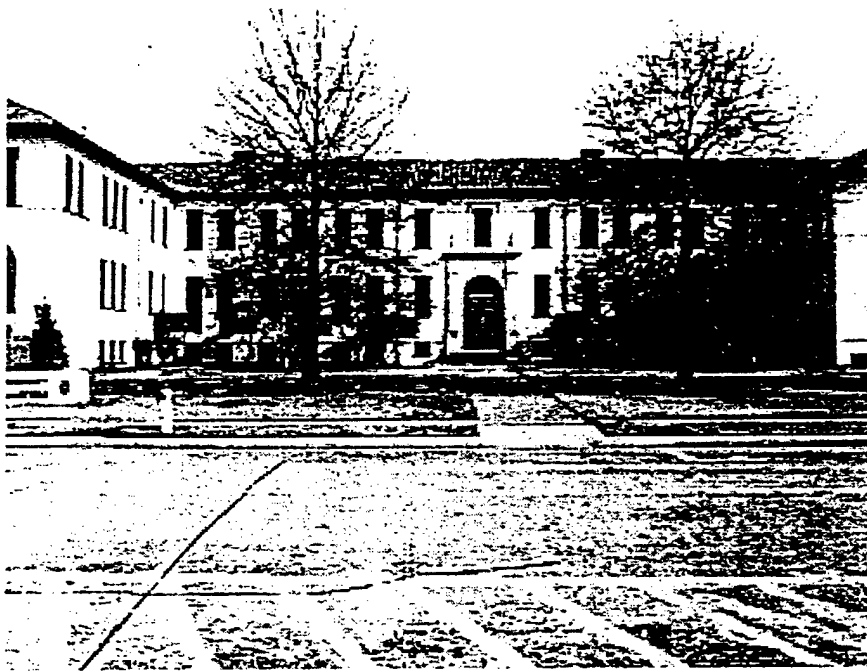

1930's Infantry Barracks at Maxell AFB, AL



1909 Infantry Barracks at (Fort D.A. Russell) F.E. Warren AFB, Wyoming



1931 Detachment Barracks at (Fort D.A. Russell) F.E. Warren AFB,
Wyoming

D. DORMITORY

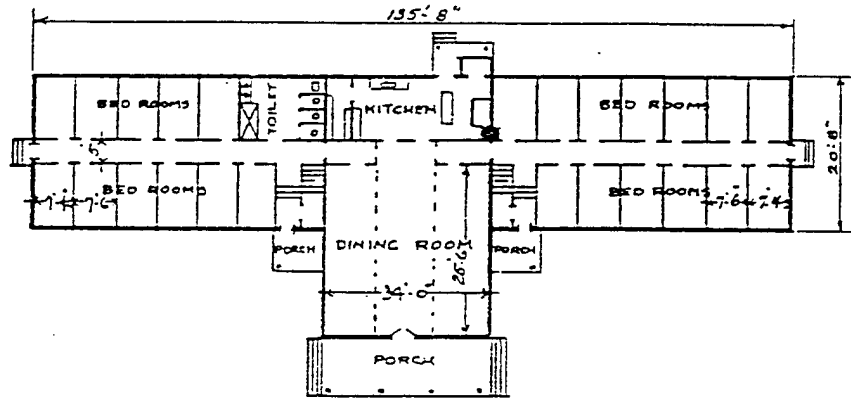
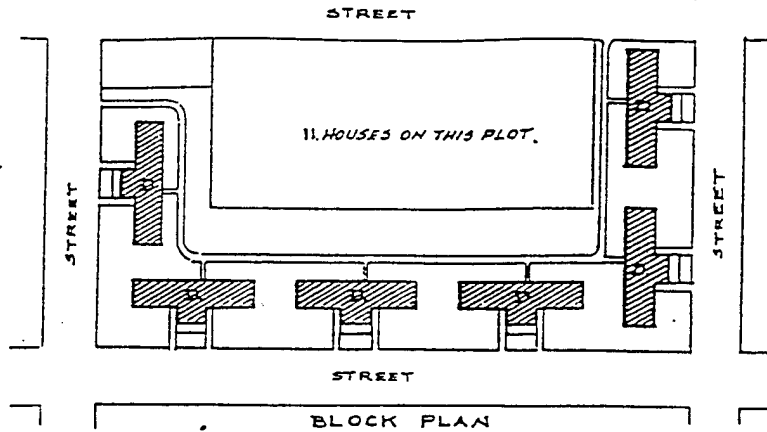

FIRST FLOOR PLAN
DORMITORY

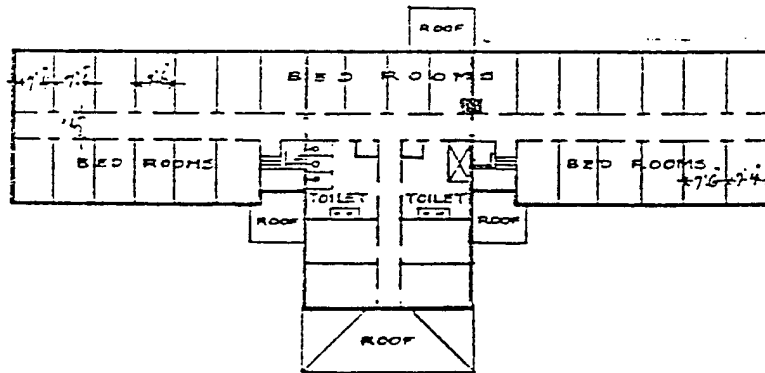

SECOND FLOOR PLAN
DORMITORY

SCALE
 0' 8' 16' 24' 32' 40'

FOR DETAILS SEE DRWGS 6307-102-121.

CONSTRUCTION DIVISION OF THE ARMY.
INDUSTRIAL HOUSING.

DORMITORIES WITH MESS.

SB-22

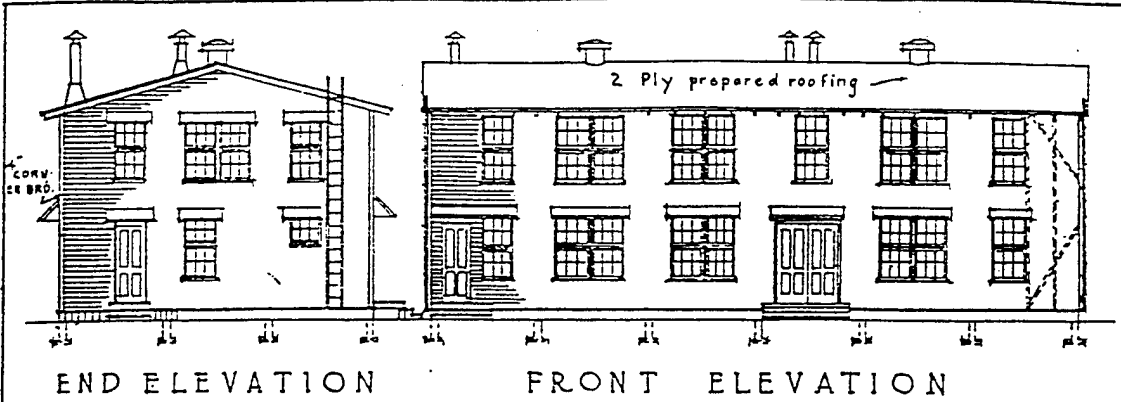

END ELEVATION

FRONT ELEVATION

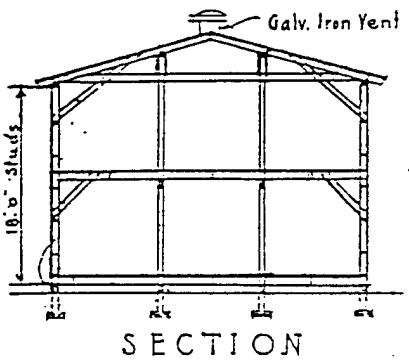

SECTION

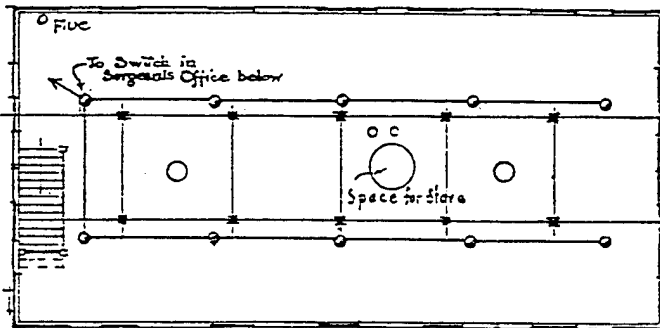

SECOND FLOOR PLAN
34 MEN

ELECTRICAL NOTE
 12x10x4 Cutout Cabinet
 30 Amp. 2 P. Plug Fused Switch
 1 2/2 wire D.E. Plug Cutout
 # 12 wire to service

SEE SHEET 620.307 for
 Specification for Electrical work

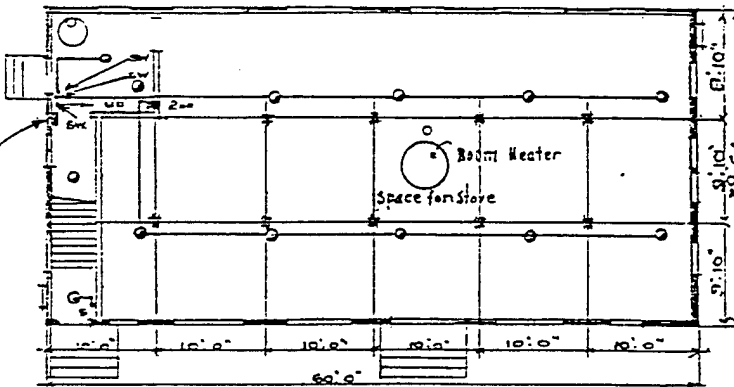

FIRST FLOOR PLAN
32 MEN

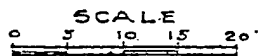

SB-4
 FOR DETAILS SEE DRAWING 620-313

CONSTRUCTION DIVISION OF THE ARMY
 TYPICAL BUILDINGS 66 MEN BARRACK

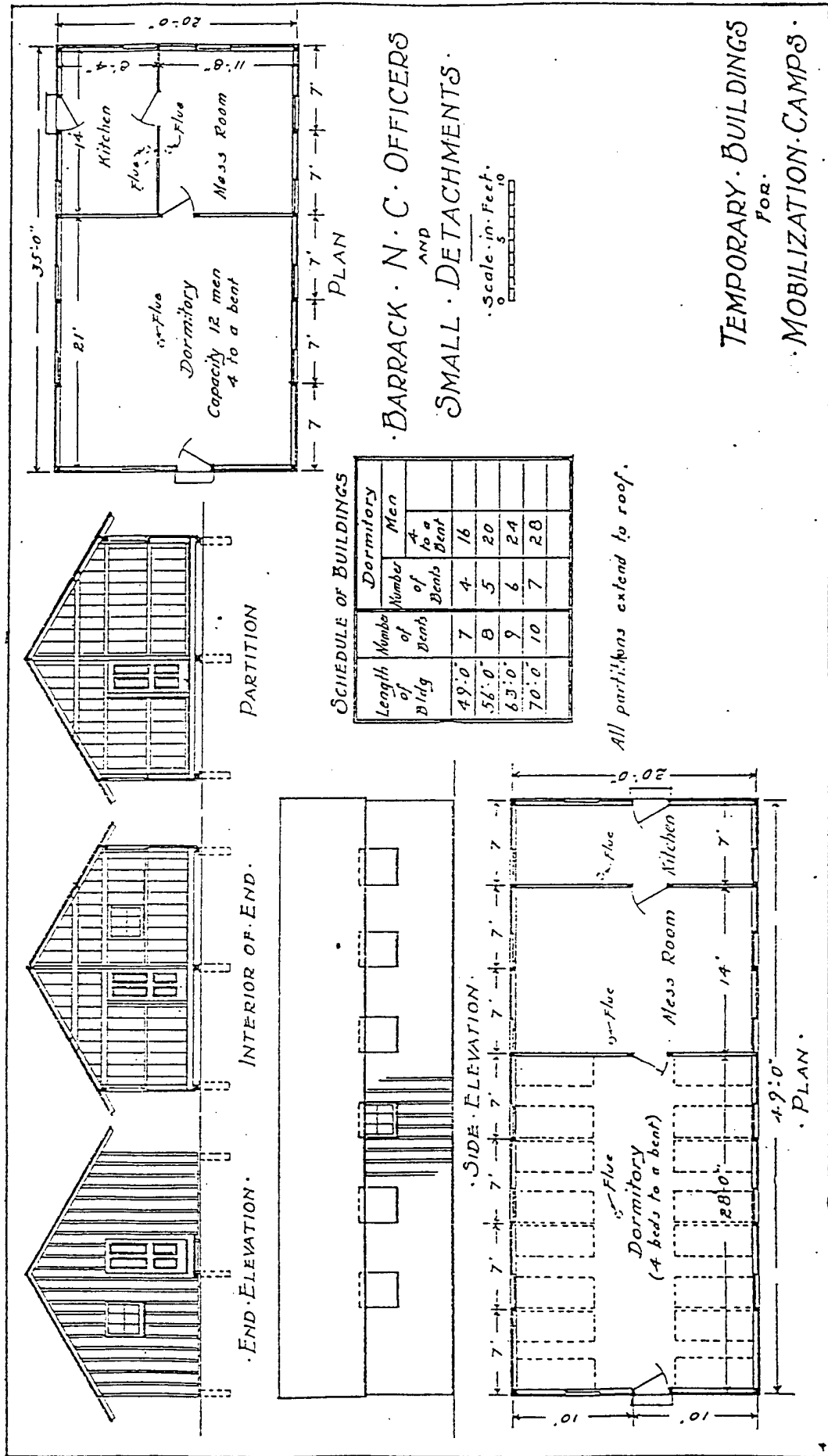

**BARRACK · N · C · OFFICERS
AND
SMALL · DETACHMENTS ·**

Scale · in · Feet ·
0 5 10

**TEMPORARY · BUILDINGS
FOR ·
MOBILIZATION · CAMPS ·**

SCHEDULE OF BUILDINGS

Length of Bldg	Number of Bents	Dormitory Men	
		Number of Bents	Men to a Bent
49·0	7	4	16
56·0	8	5	20
63·0	9	6	24
70·0	10	7	28

All partitions extend to roof.

INTERIOR OF · END ·

· SIDE · ELEVATION ·

· PLAN ·

SCHEDULE - BARRACKS.

Each Barrack has 2 Bents for office, &c.	Dormitory Bents.										Totals	Number of Men.	
	Length	Number of Bents	Door	Window	Door	Window	Door	Window	Door	Window			
65	9	3	1	3	1	3	1	3	1	3	6	17	37
70	10	3	1	4	1	4	1	4	1	4	7	18	43
77	11	4	1	4	1	4	1	4	1	4	10	19	49
91	13	3	1	3	1	3	1	3	1	3	9	21	55
98	14	3	1	4	1	4	1	4	1	4	10	22	61
105	15	3	1	4	1	4	1	4	1	4	11	23	67
112	16	4	1	4	1	4	1	4	1	4	12	24	73
126	18	3	1	3	1	4	1	3	1	3	13	26	79
133	19	3	1	4	1	4	1	3	1	3	14	31	85
140	20	3	1	4	1	4	1	4	1	4	15	31	91
147	21	4	1	4	1	4	1	4	1	4	16	31	97

NOTE:—

Each door bent to have a flue.
All partitions extend to roof.

BARRACK - ENLISTED - MEN.

Scale: 1/8" = 1'-0"

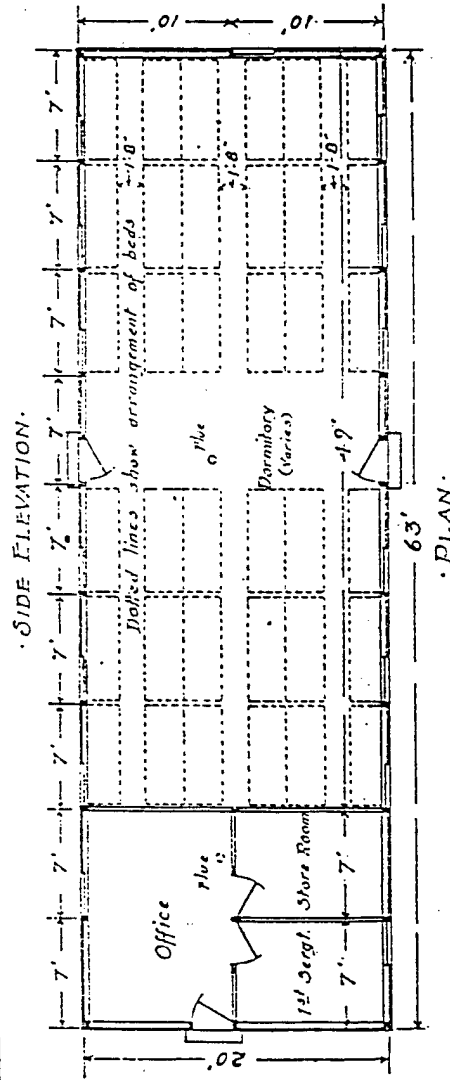
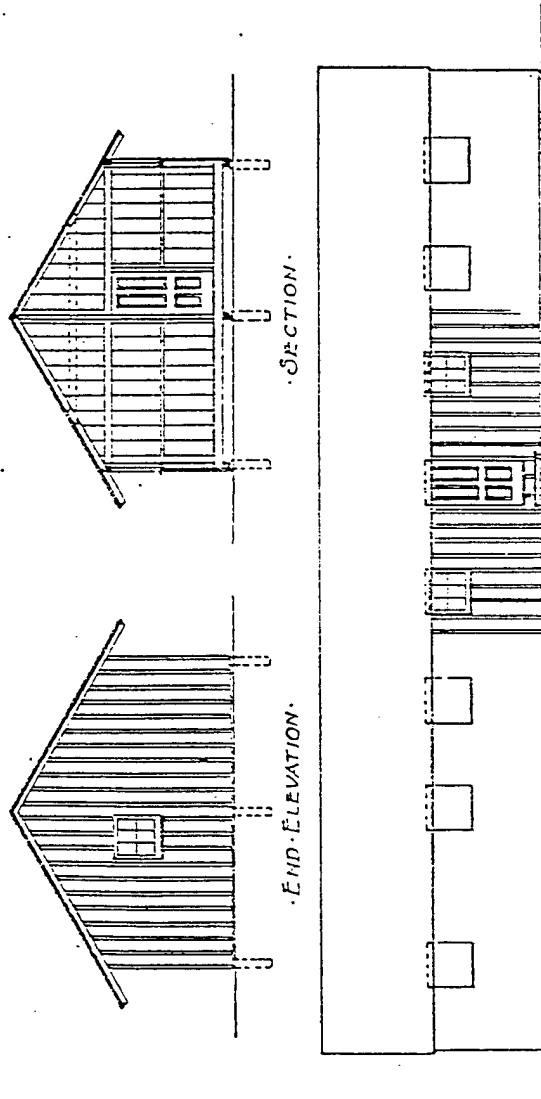

TEMPORARY BUILDINGS.
FOR
MOBILIZATION CAMPS.

APPENDIX NO. 16-5.

*Notes: 1. Iron columns & strappings not wrought-iron
 2. Pipe railing, as indicated in detail on sheet
 3. It has been substituted for the wood porch and
 4. Railings of veranda, porch and platform, shown
 5. in elevation in this sheet.*

*Contracting Quartermaster Office
 Fort Riley, Kansas, Sept. 22, 1892
 George R. Baker,
 Captain U. S. Army,
 In Charge of Construction.*

*Artillery Barracks - 80 Men
 Fort Riley, Mo.*

*Designed by Capt. Geo. F. Thayer,
 U. S. Army, 1892. Scale, 1/4" = 1'.*

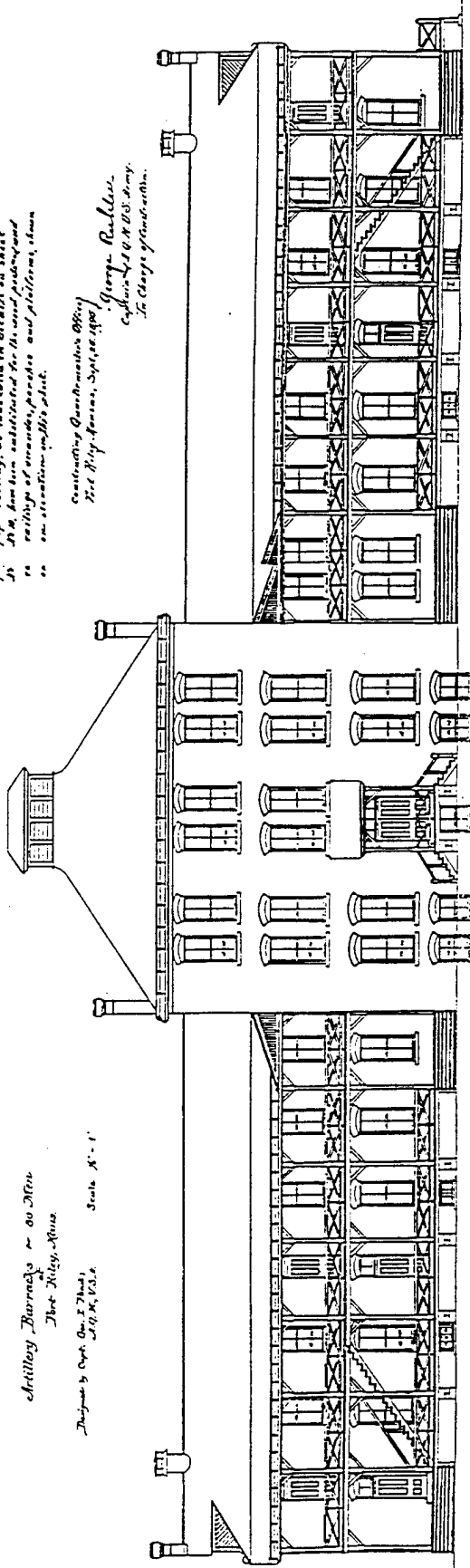

*Front Elevation
 Scale 1/4" = 1'*

U. S. File A13-10

S

103 1000001217

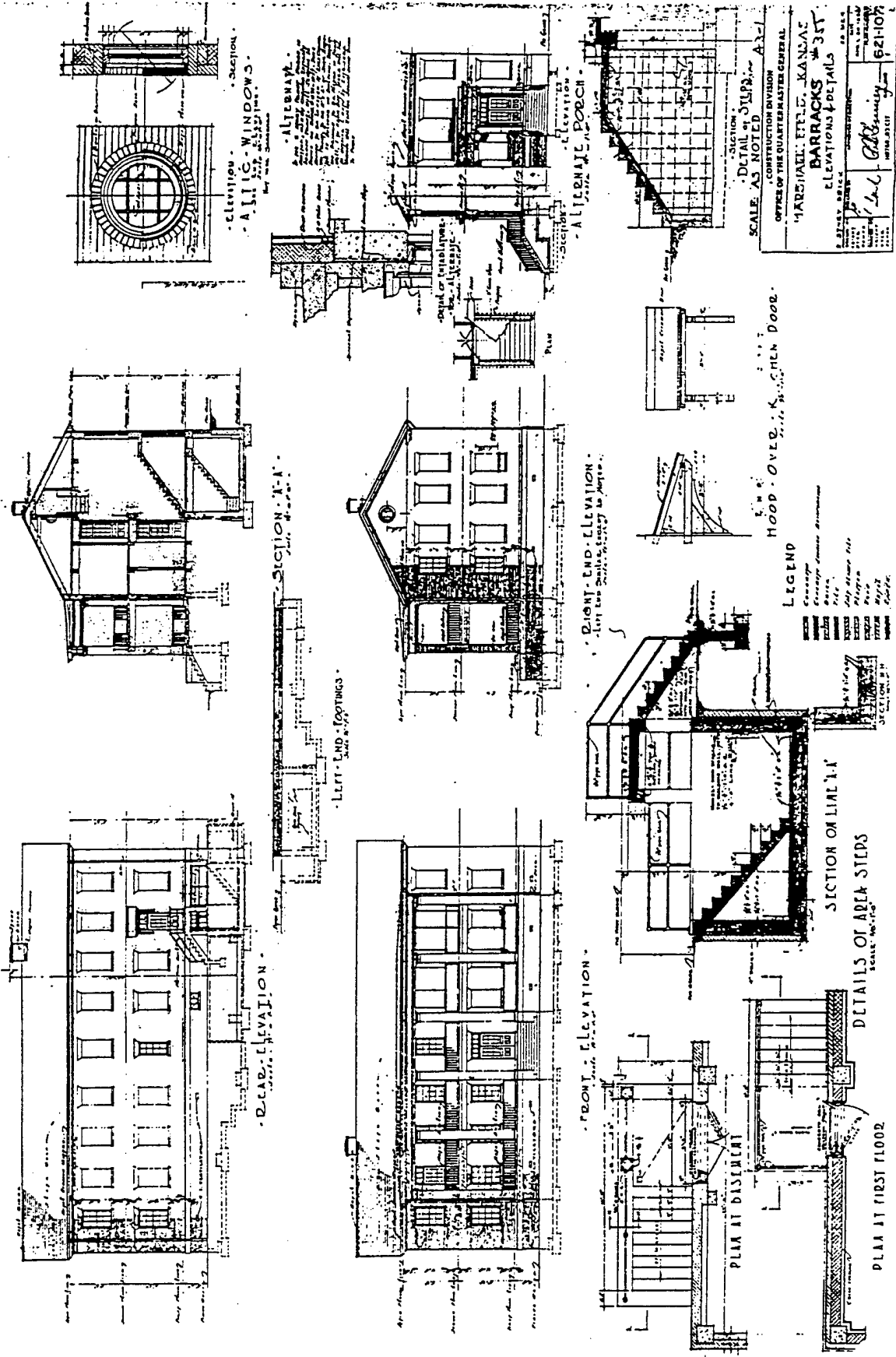

OFFICE OF THE QUARTER MASTER GENERAL
 MADISON, ILL. KANSAS
 BARRACKS NO. 357
 ELEVATIONS & DETAILS
 SCALE AS NOTED
 DRAWN BY [Signature]
 CHECKED BY [Signature]
 DATE [Date]
 SHEET NO. 621-HO7

A 3-1
 10780.03.c11

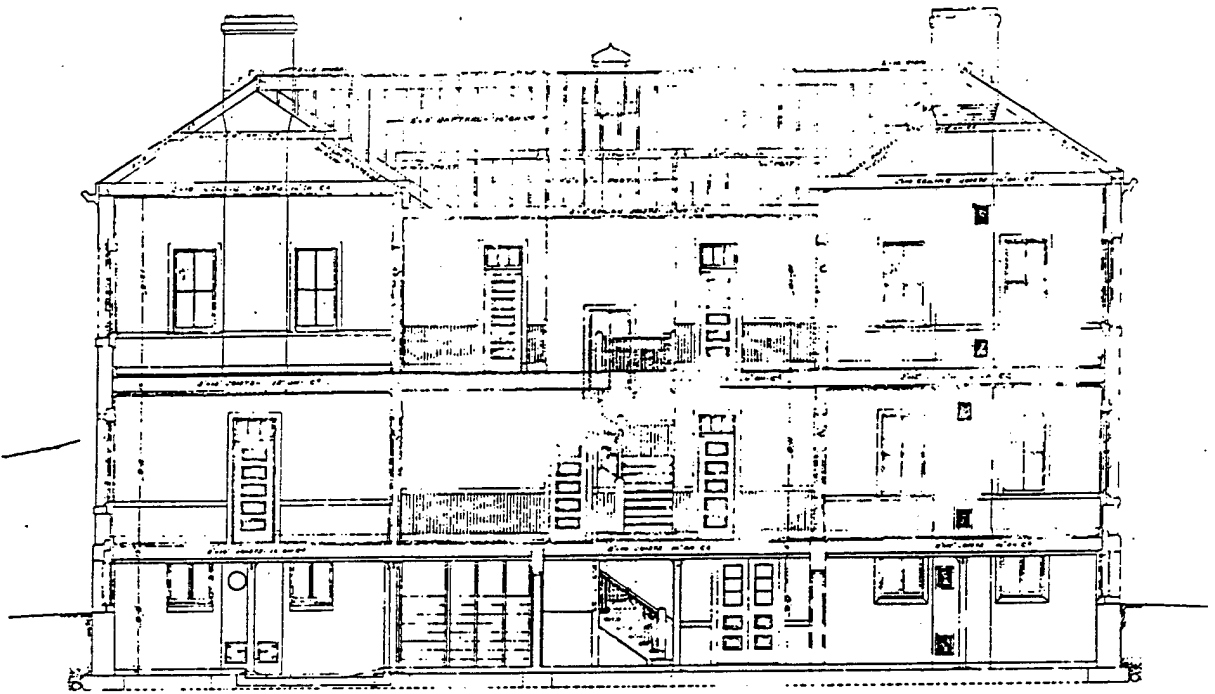

SECTION ON LINE A-B.
SCALE 1/4" = 1'-0"

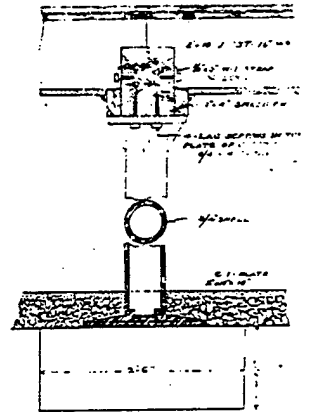

DETAIL OF C1 COLUMN.
SCALE 1/4" = 1'-0"



SIDE ELEVATION.
SCALE 1/4" = 1'-0"

NO 207-03.C11

AND BARBACK.

SHEET NO. 3 61-F. CONSTRUCTION & DETAILS
STEEL WORKING

JUN 1 1907

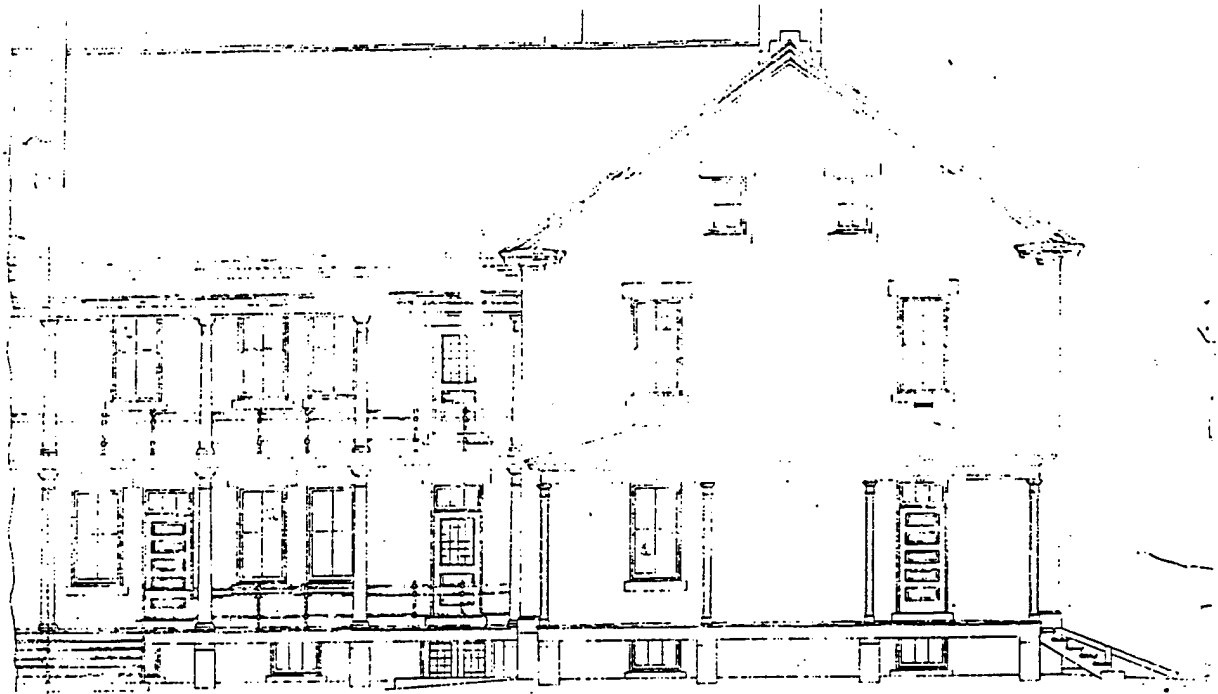

REAR ELEVATION
SCALE 1/4 INCH



FRONT ELEVATION
SCALE 1/4 INCH

no 208.01.c1

SHEET NO. 77 OF 9 SHEETS
CAVALRY BARRACK

SAN FRANCISCO, CALIF. JAN. 1902

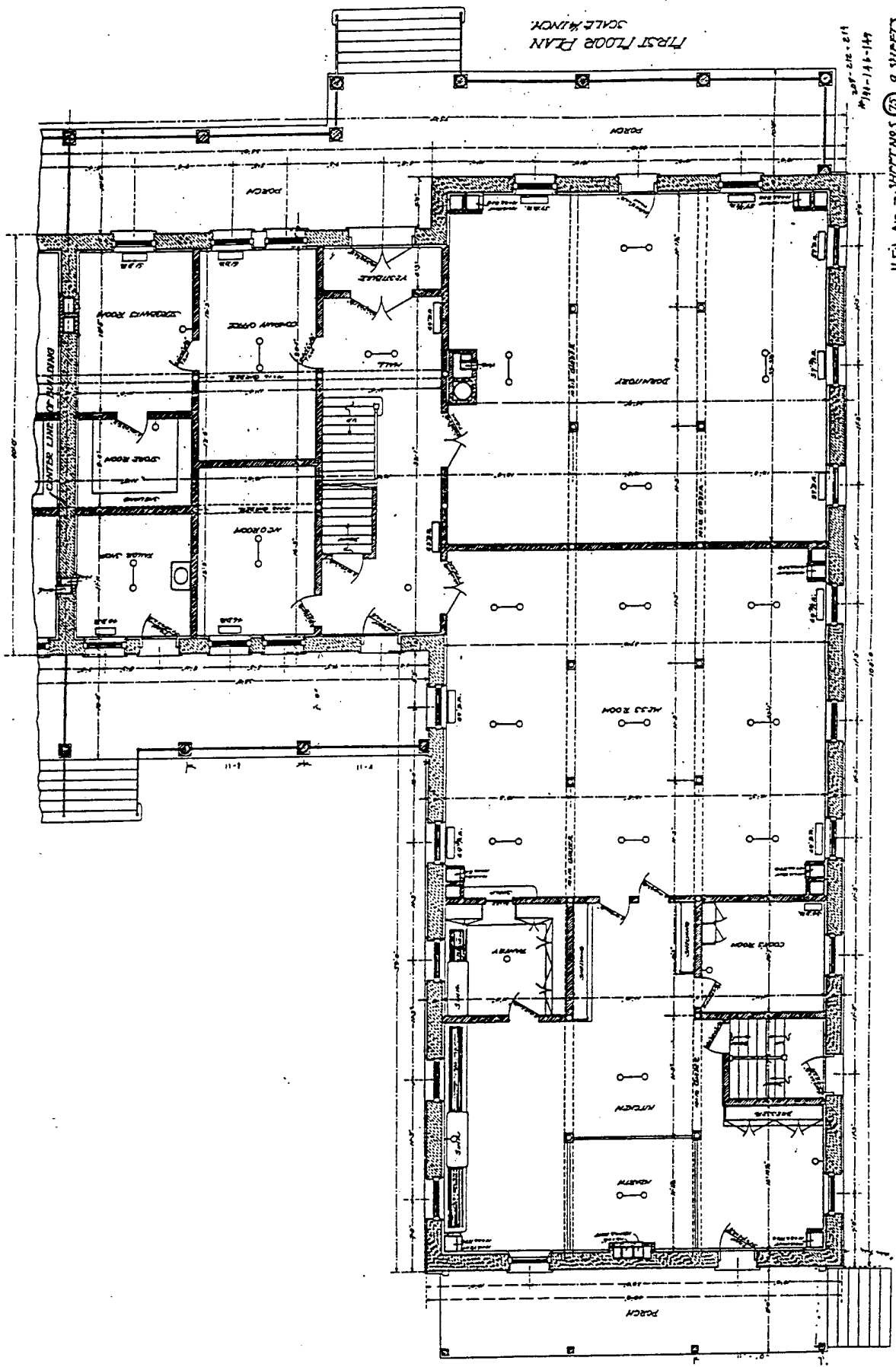

FIRST FLOOR PLAN
SCALE 1/8" = 1'-0"

U File A13-7 SHEETS NOS ⑦ 9 SHEETS
 1902-14-14
 Q.M.G.O. JAN 1902
 HO208.10.c11

Project: Public Cavalry Barracks

For: Army, Army

Scale: 1/4" = 1'-0"

Architect: Capt. Geo. W. Thayer, A.S.C.

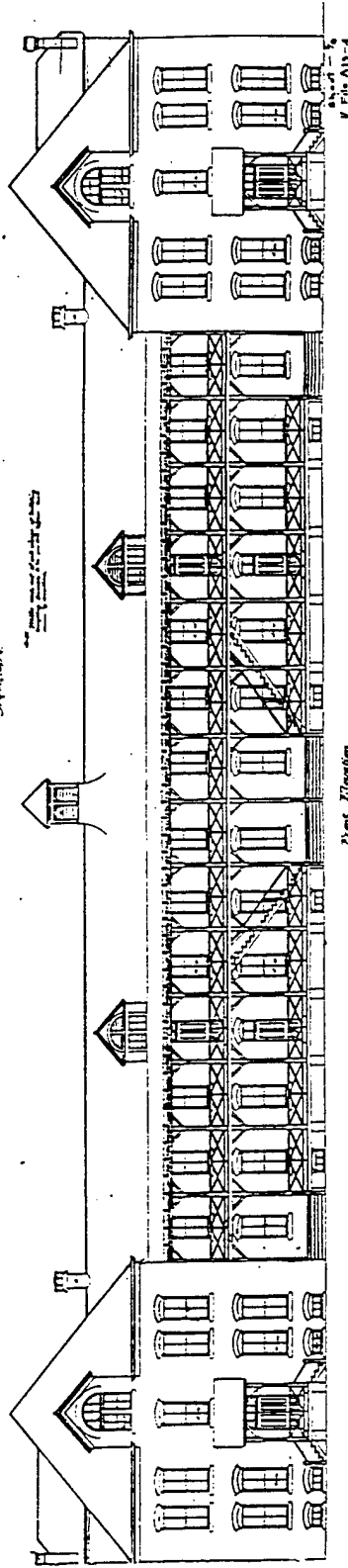

Plan: 11/10/10

File: 113-4

NO 211.27.cil

PLAN NUMBER 5

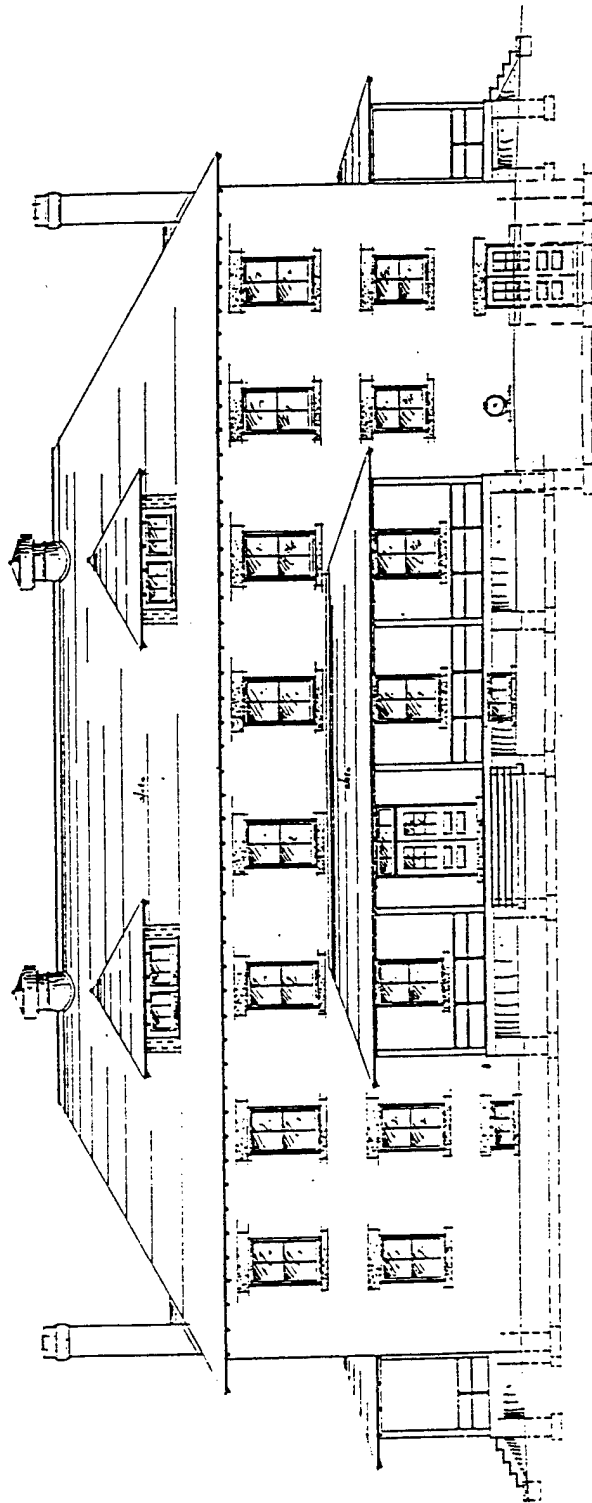

FRONT ELEVATION
SCALE 3/8" = 1'-0"

1918
QUARTERS FOR PACKERS
IN ACCORDANCE WITH
REQUIREMENTS OF THE
OFFICE OF SUBSISTENCE Q. M.
SERIAL 1-1
BY W. A. S. D.
1918
DRAWN BY
11020.08.G11

Category: RESIDENTIAL

Type 9 b-1: Institutional Housing Support Buildings: Detached Lavatories/Bathhouses

Description:

Detached lavatories, sinks (latrines or outhouses), and bathhouses are support structures to barracks and family housing. These one-story, utilitarian structures generally were located near housing facilities. During the nineteenth and early twentieth centuries, detached lavatories, outhouses, and bathhouses were common property types. Few remain due to the incorporation of indoor plumbing in military housing.

Evolution:

Army Regulations issued in 1821 set minimum standards of personal cleanliness for the troops; they were required to have clean uniforms and to wash their faces and hands daily.⁸ Despite these regulations, the Army provided no appropriations to fund the construction of latrines or bathhouses. The Secretary of War routinely rejected all plans and estimates for such facilities; troops, rather than the government, were expected to pay for their personal cleanliness.⁹ The earliest sinks built of permanent materials identified during this study were stone facilities constructed at Ft. Sill, Oklahoma, during the 1870s. Buildings labeled as wash houses on nineteenth-century post plans were for clothes washing, not bathing. Officer quarters usually had an individual latrine, while the soldiers living in the barracks shared a larger facility.

In the West, communal detached latrines and bathhouses became prevalent for barracks at such places as Fts. Huachuca, Bliss, and Riley, during the late nineteenth and early twentieth centuries. These buildings contained indoor plumbing for toilets and bathing facilities. They were located behind the barracks, and often served the residents of two barracks. On some western posts, permanent detached lavatories were not constructed until World War I.

After 1891, new officer housing and barracks were constructed with indoor bathrooms and toilets. Officer quarters had a room with a bathtub, wash basin, and water closet and occasionally a servant's bathroom and water closet in the basement. However, not all regions of the country received indoor plumbing at the same time. At older posts, such as at the Department Headquarters post at Ft. Sam Houston, Texas, the officers and their families continued to use detached outhouses behind the quarters. Individual water closets behind officer quarters were still common in 1904 according to post plans from that year.¹⁰ The most popular addition to older residences was a bathroom with indoor toilet.

⁸ David A. Clary, *These Relics of Barbarism: A History of Furniture in Barracks and Guardhouses of the United States Army 1800 - 1880*, MSS, Department of the Interior, National Park Service, Harper's Ferry Center, West Virginia, 58.

⁹ Risch, *Quartermaster Support of the Army*, 488-489.

¹⁰ NARA, Cartographic Branch, RG 92, Post Plans, 1904 - 1905.

Surviving lavatories are generally one-story utilitarian buildings located behind officer housing and barracks complexes. They were constructed of permanent materials such as brick or stone, and match the barracks or housing complex. By the 1930s, indoor bathrooms and toilets were included automatically in the designs of barracks and housing.

Association:

Detached lavatories are a minor property type associated with housing complexes that pre-date the widespread construction of indoor plumbing. They are associated with the improvement of living standards for military personnel as the military began to construct larger, more permanent facilities. The construction of detached lavatories and bathhouses also is related to improvements in plumbing and the growing awareness of the connection between hygiene and health. These buildings do not possess individual significance, but may be contributing elements in an installation historic district if they are related physically to a barracks or housing area.

Integrity:

To possess integrity, detached lavatories and bathhouses should retain most of their exterior features from the period of significance of the historic district. Most detached lavatories and bathhouses no longer serve their original functions. They often have been converted into storage facilities. Exterior elements that may have been modified include window and door openings. Where subsequent additions or renovations have occurred, detached lavatories and bathhouses still may have integrity if they retain their location and the majority of their setting, association, materials, and design.

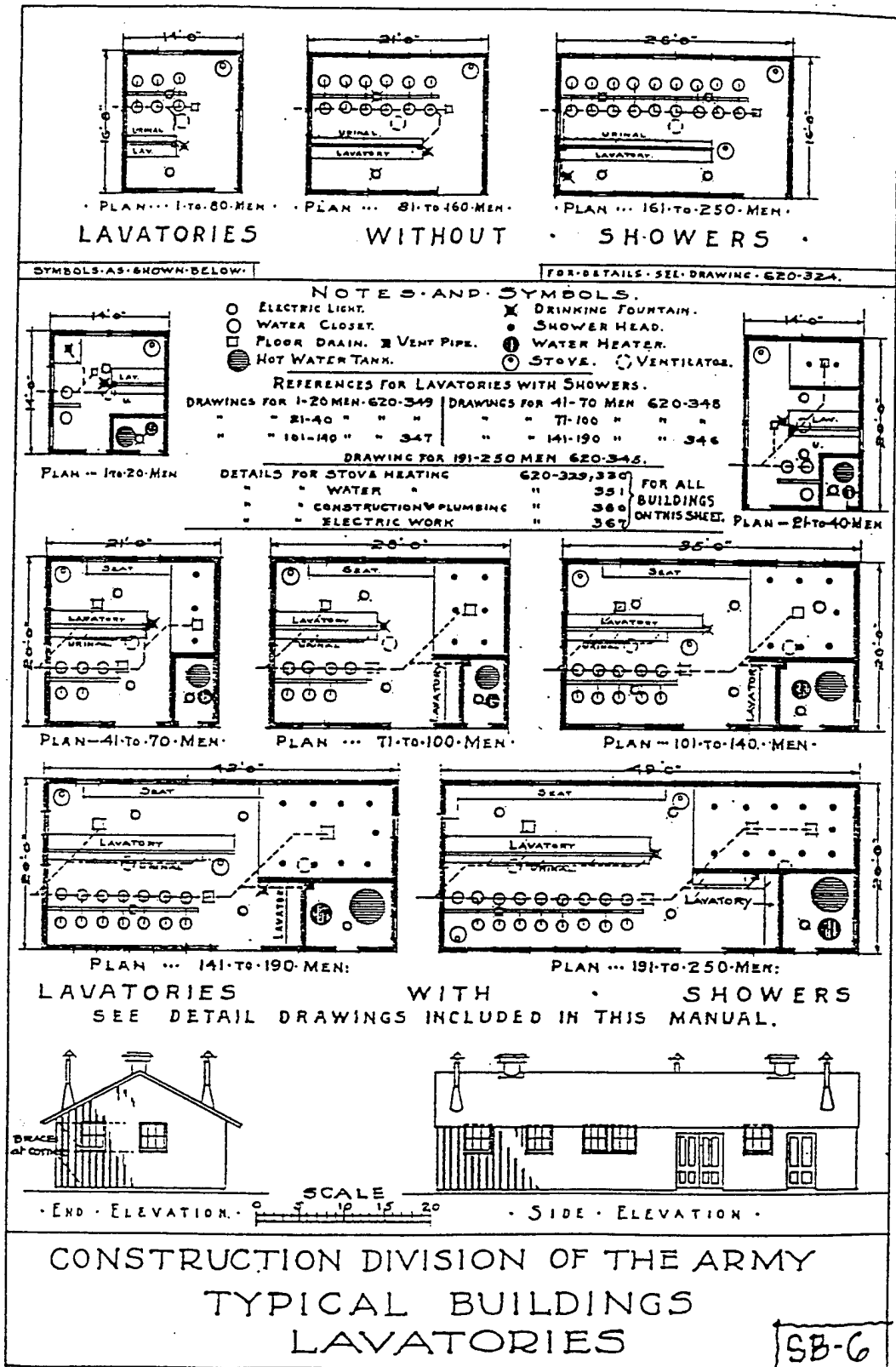

LAVATORIES WITHOUT SHOWERS

SYMBOLS AS SHOWN BELOW

NOTES AND SYMBOLS

- ELECTRIC LIGHT
- WATER CLOSET
- FLOOR DRAIN
- HOT WATER TANK
- ✕ DRINKING FOUNTAIN
- SHOWER HEAD
- WATER HEATER
- STOVE
- VENTILATOR

REFERENCES FOR LAVATORIES WITH SHOWERS

DRAWINGS FOR 1-20 MEN	620-349	DRAWINGS FOR 41-70 MEN	620-348
" 21-40 "	" 347	" 71-100 "	" 346
" 101-140 "	" 347	" 141-190 "	" 346

DRAWING FOR 191-250 MEN 620-345

DETAILS FOR STOVE HEATING

" WATER	620-329, 330	FOR ALL BUILDINGS ON THIS SHEET
" CONSTRUCTION PLUMBING	" 351	
" ELECTRIC WORK	" 366	

FOR ALL BUILDINGS ON THIS SHEET

351

366

367

368

369

370

371

372

373

374

375

376

377

378

379

380

381

382

383

384

385

386

387

388

389

390

391

392

393

394

395

396

397

398

399

400

401

402

403

404

405

406

407

408

409

410

411

412

413

414

415

416

417

418

419

420

421

422

423

424

425

426

427

428

429

430

431

432

433

434

435

436

437

438

439

440

441

442

443

444

445

446

447

448

449

450

451

452

453

454

455

456

457

458

459

460

461

462

463

464

465

466

467

468

469

470

471

472

473

474

475

476

477

478

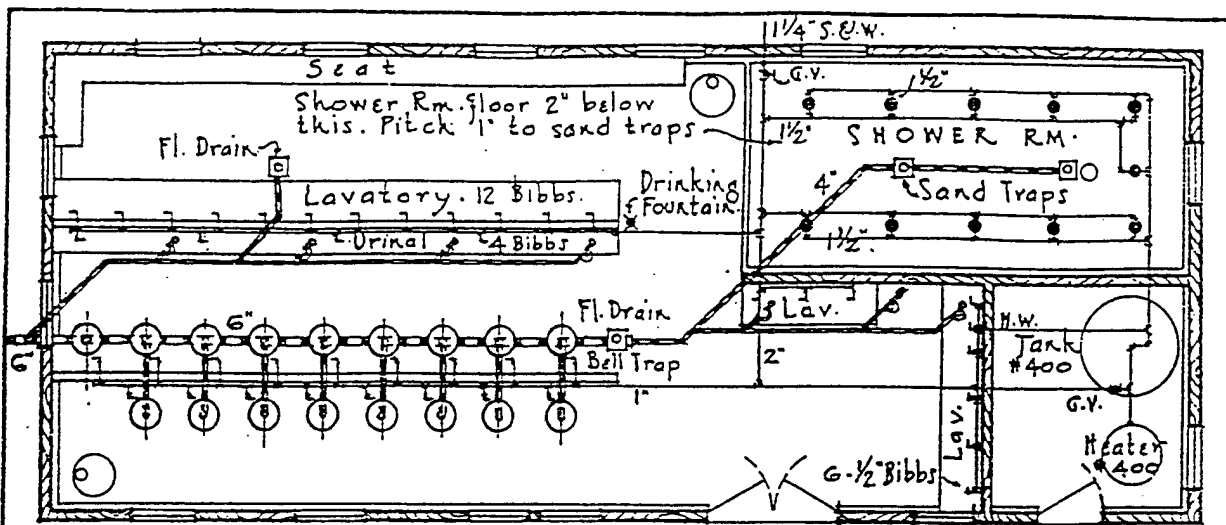

PLAN
191 TO 250 MEN.

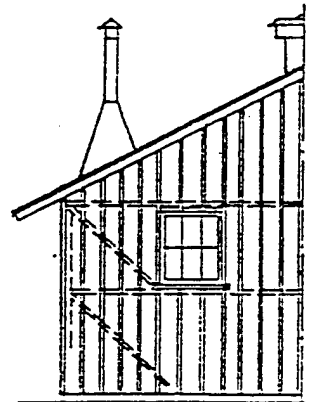

HALF END ELEVATION.

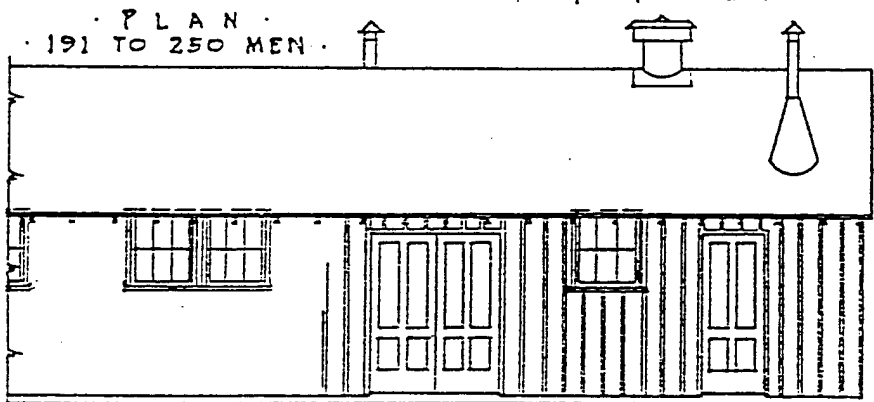

PART SIDE ELEVATION

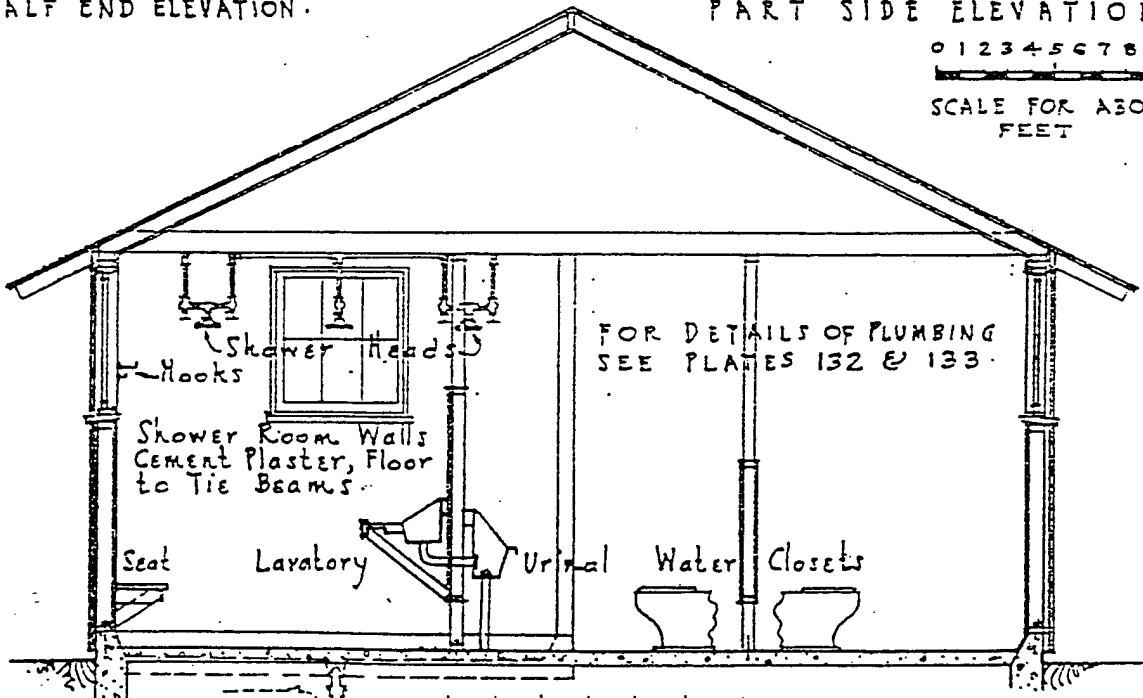
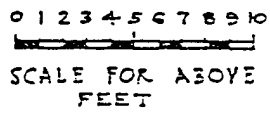

TRANSVERSE SECT'N.

0 1 2 3 4 5

SCALE FOR SECTION

For Details see drawings:—
620-329, 330, 345, 350, 351, 367.

CONSTRUCTION DIVISION OF THE ARMY
TYPICAL BUILDINGS
LAVATORY DETAILS

CD-7

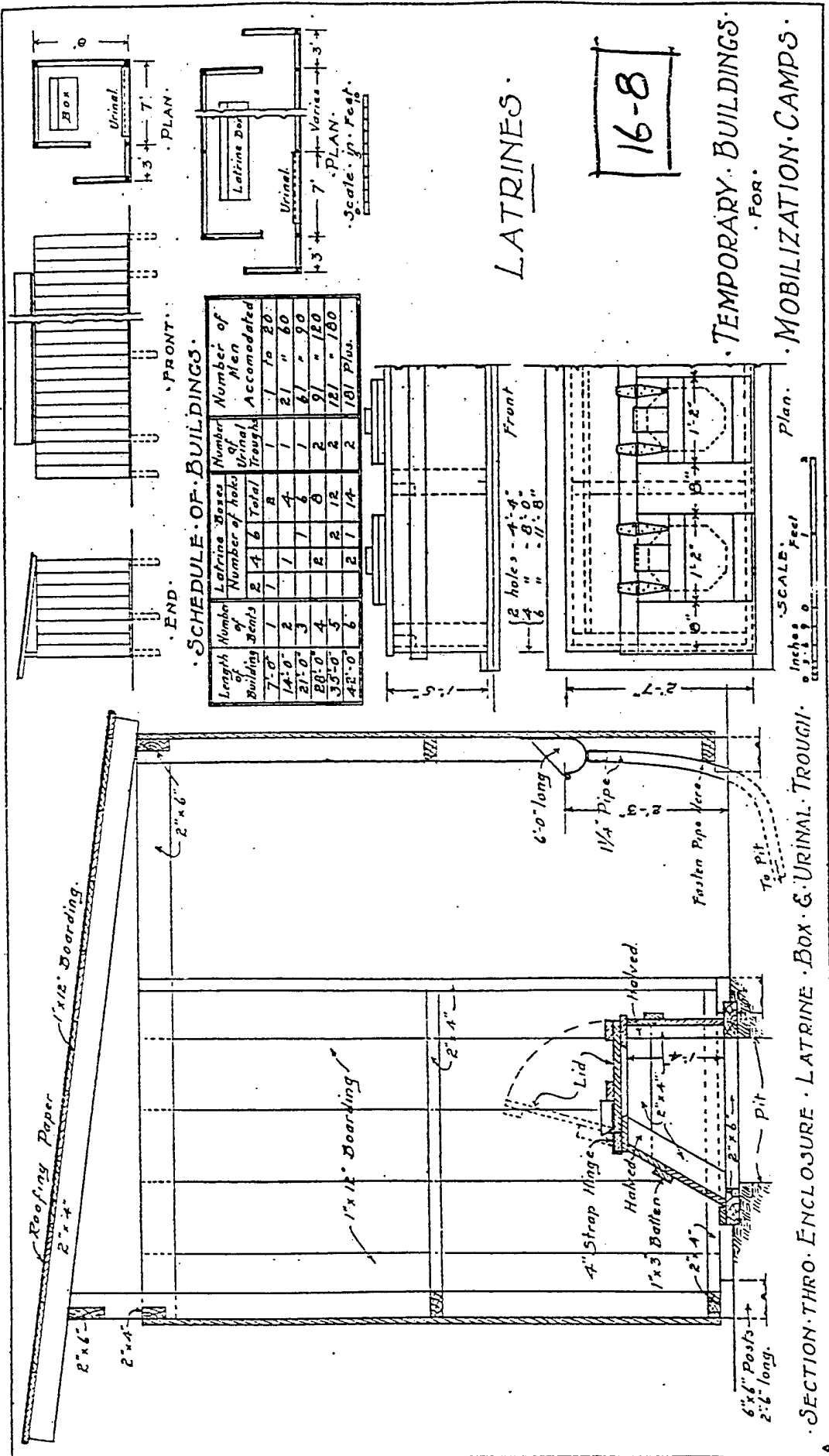

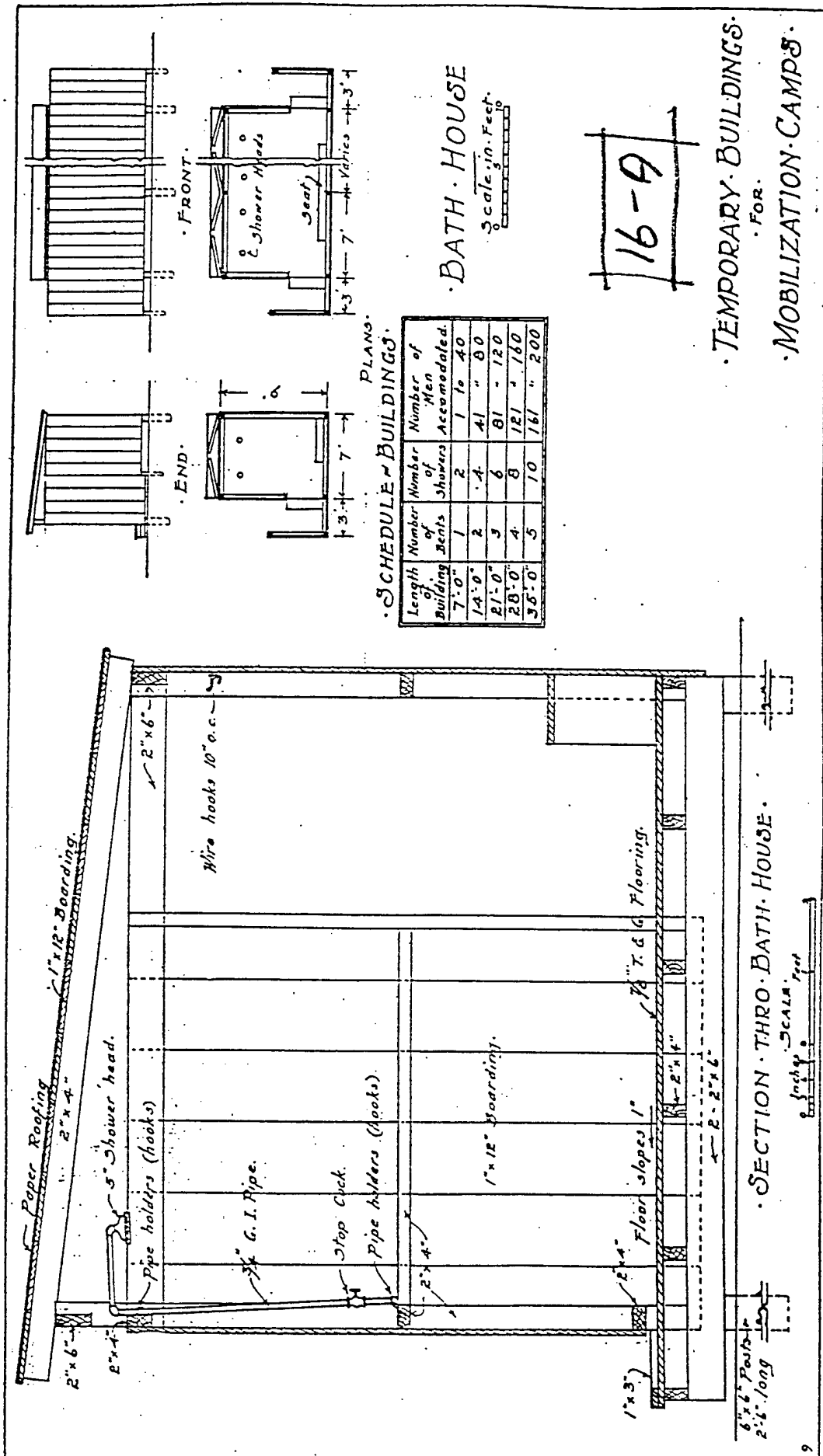

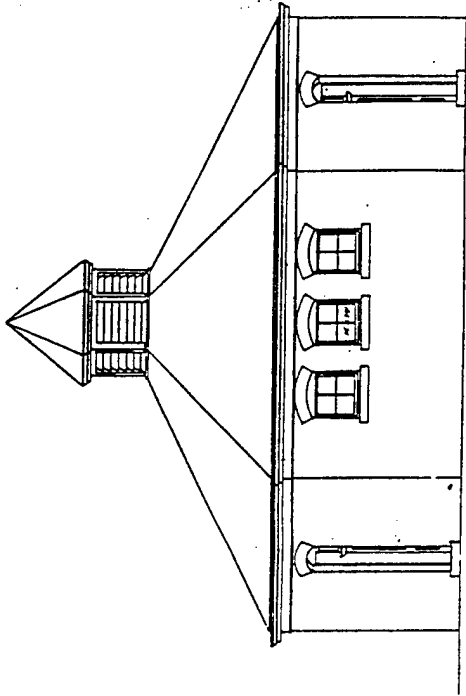

Elevation—

Outhouses & Cavalry Barracks

Fort Riley, Kans.

Capt. Geo. E. Bond,
A. Q. M., U.S.A.

Scale 1/4" = 1'

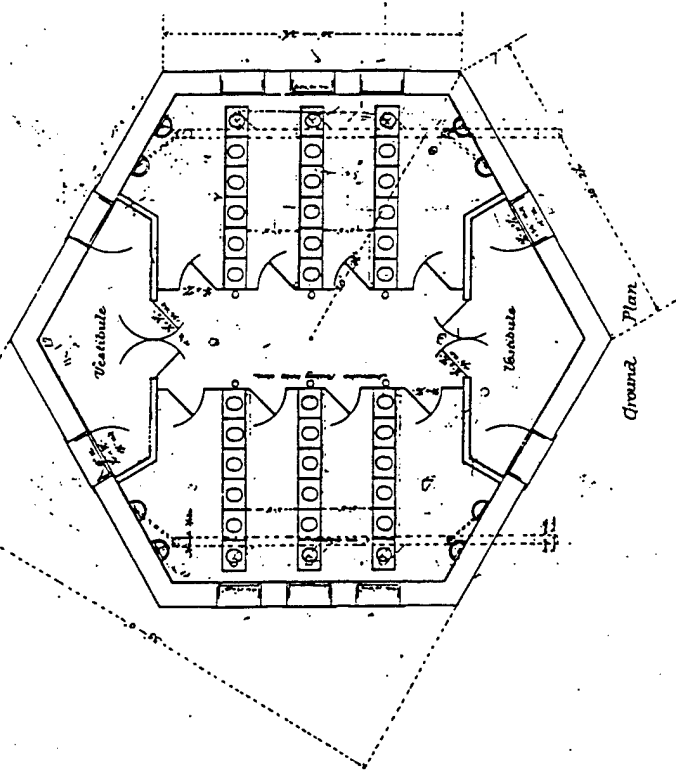
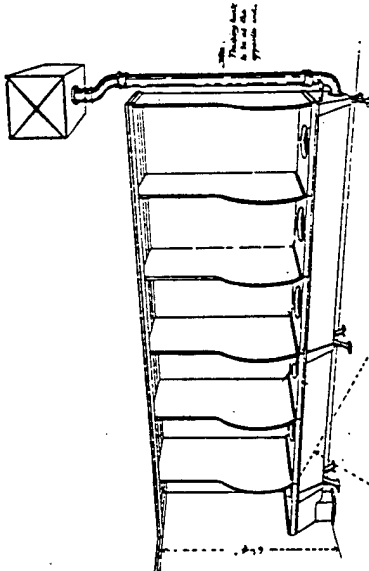
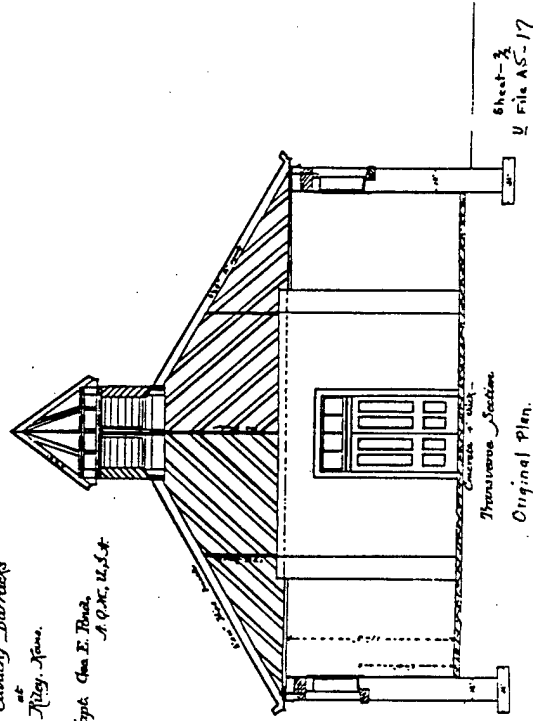

441

1285
MANAGER

Category: RESIDENTIAL

Type 9 b-2: Institutional Housing Support Buildings: Mess Halls

Description:

Mess halls housed kitchens and dining facilities for military personnel. Mess hall buildings included a dining room, kitchen, cook's room, dish pantry, and storerooms. Mess halls were built near barracks complexes. Mess halls shared the same construction materials and architectural character as the adjacent barracks. The buildings were usually one story, though they often had high ceilings that gave them the exterior appearance of a two-story building.

Evolution:

The Army provided enlisted personnel with food rations through the mess system. Officers paid the officers mess for their own food. Officers dined in the officers mess in the bachelor officers quarters, or in the case of married senior officers, in their family quarters. The mess halls and kitchens for enlisted men were contained in the barracks. In a one-story barracks, the kitchen and mess room were located in a rear wing; in a two-story barracks, on the first floor. Food distribution generally was organized by company, with each company living and eating together.

As the Army consolidated its troops into larger, permanent posts during the 1880s and 1890s, the Quartermaster Department experimented with the idea of a single mess for all enlisted personnel in one building. The Army constructed its first consolidated mess at the recruiting depot at David's Island, New York, in 1888. Common mess halls were adopted at a number of larger posts by 1893. Advantages of the consolidated mess over the company mess included better cooking and greater economy of meal preparation.¹¹

In 1893, the Quartermaster General reported that mess halls existed at Ft. Bliss, Ft. Brady, Davids Island, Jefferson Barracks, Ft. McPherson, Plattsburgh Barracks, Ft. Riley, Ft. Sam Houston, Ft. Sheridan, and Ft. Thomas. In addition, consolidated messes were established at Ft. Myer, Key West Barracks, Ft. Schuyler, Ft. Warren, and Willets Point. In response to critics of the consolidated mess, the Quartermaster General recommended no further construction of the consolidated mess until time and further trial have removed the objections brought against it. The Quartermaster General maintained that the introduction of "scientific" cooking would improve the health and well-being of the troops.¹²

Examples of the consolidated mess were identified at Forts Bliss, McPherson, and Riley. At Ft. Bliss, Texas, the mess hall building is located between two two-company barracks. The T-shaped building is composed of a two-story principal block and a one-story rear kitchen wing. A Quartermaster Department plan for a mess hall at Ft. Crook (now Offutt AFB), Nebraska, indicates that the second floor offices held a school room and a library. At Ft. Riley, Kansas, the

¹¹ Risch, *Quartermaster Support of the Army*, 507.

¹² War Department, *Annual Reports of the Quartermaster-General*, Washington, D.C.: Government Printing Office, 1893, 10-11.

mess hall was located between two groups of barracks. By 1904, post plans indicate that the building was converted to a post exchange and gymnasium, and that rear wings were, added to two of the barracks, probably for the addition of mess rooms and kitchens to the barracks.¹³

The Army generally abandoned consolidated messes after 1896 and returned to the practice of including kitchens and mess rooms for each company within barracks.¹⁴ Consolidated messes did not regain popularity during the 1930s era of Army construction. Permanent barracks constructed during the 1930s contained their own kitchens and mess rooms. One exception was at Randolph AFB, Texas, an Army Air Corps training field, at which a separate mess building was built for the cadets behind the cadet barracks. The Randolph mess hall was designed in the same Spanish Colonial architecture as the other buildings of the airfield. During mobilization for the First and Second World Wars, the Army constructed separate mess halls at its mobilization cantonments; these mess halls were built according to standardized plans using temporary, wood-frame construction.

Association:

Mess halls often are major support buildings at installations. Mess halls are associated with the evolution of living standards for military personnel and with the development of installation support facilities. The construction of mess halls is related to the historical development of the services. At Army installations, detached mess halls usually are related to a distinct period of construction during the late nineteenth century. Mess hall buildings often reflect the influence of civilian architecture on military designs and usually are similar to barracks architecture. Mess halls generally do not possess individual significance, but may be major contributing elements to an installation historic district.

Integrity:

To possess integrity, mess halls should retain their physical relationship to adjacent barracks and most of their architectural ornamentation, design features, and external construction materials from the period of significance of an historic district. Few mess halls retain their original use. Most have been modified to serve administrative or recreational uses. Major changes include the removal of porches and the modification of window and door openings and materials. Where subsequent additions or renovations have occurred, mess halls still may have integrity if they retain their location and the majority of their setting, materials, design, and association. In most cases, even with major modification, mess halls may be contributing elements in an historic district as supporting buildings related to a barracks complex.

¹³ NARA, Cartographic Branch, RG 77, Standard Plans of Army Post Buildings, 1891-1918, Plan 56-, NARA, Cartographic Branch, RG 92, Post Plans, Ft. Riley, Kansas.

¹⁴ David A. Clary, *A Life Which is Gregarious in the Extreme: A History of Furniture in Barracks, Hospitals, and Guardhouses of the United States Army, 1880-1945*, MSS, U.S. Department of the Interior, National Park Service, Harpers Ferry Center, West Virginia, 1983, 29.

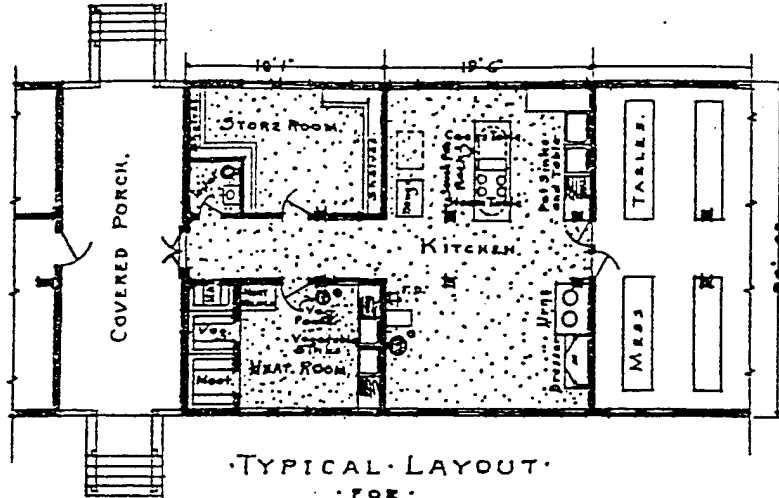

TYPICAL LAYOUT
FOR

NURSES OR OFFICERS KITCHEN AND MESS

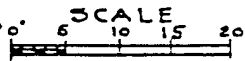

FOR DETAIL PLAN, SEE SURGEON GENERAL'S OFFICE, SHEET 1-D11.

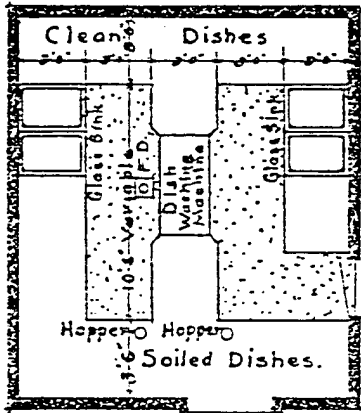

DOUBLE SERVICE ROOM

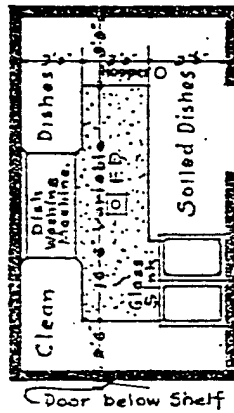

Door below Shelf

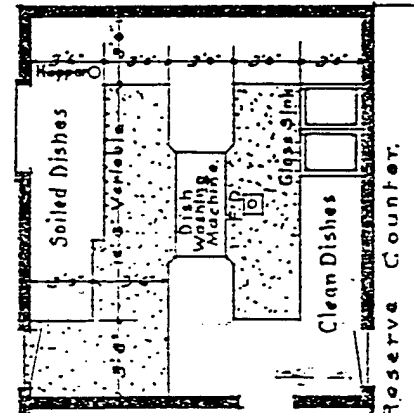

Reserve

Reserve Counter

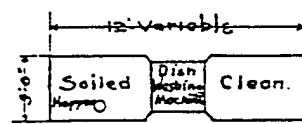
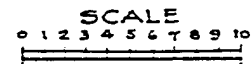
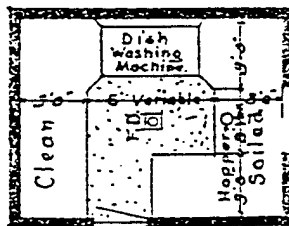
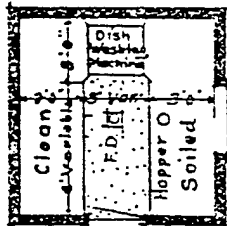

TYPICAL DISH WASHING PANTRIES
FOR HOSPITAL AND MESS KITCHENS

CONSTRUCTION DIVISION OF THE ARMY
HOSPITAL BUILDINGS
TYPICAL KITCHEN LAYOUT

SB-13

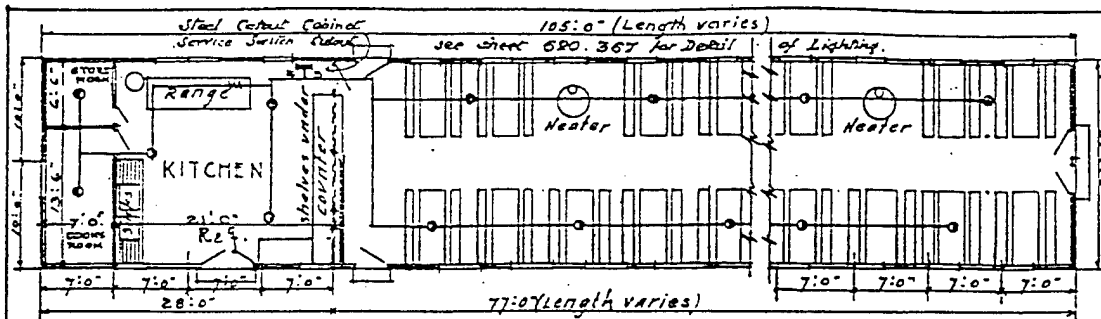

PLAN (MESS SEATING MORE THAN 75 MEN)

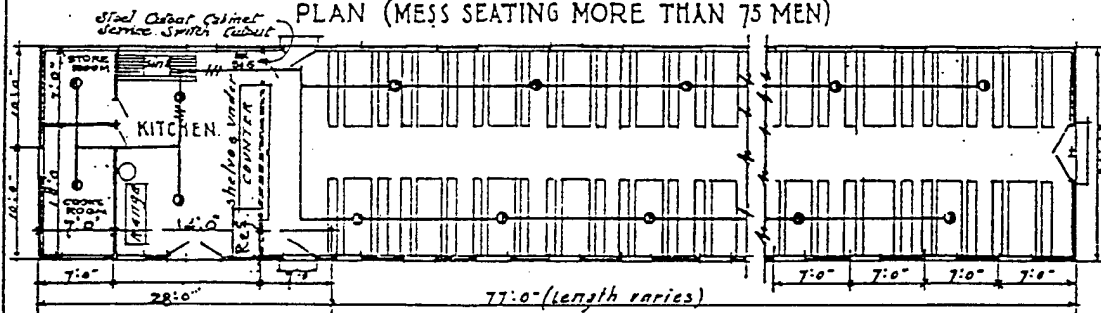

PLAN OF KITCHEN (MESS SEATING LESS THAN 75 MEN)

NOTE
DETENTION AND QUARANTINE CAMPS TO HAVE T AND G SCREENS BETWEEN BENCHES IN MESS ROOM.



STEAM HEAT		SCHEDULE						
INDEPENDENT HEATING PLANT	CENTRAL HEATING PLANT	LENGTH OF BUILDING	LENGTH OF MESS	NUMBER OF MEN SEATED	RANGES CAPACITY (MAN)	ROVERS CAPACITY	HEATERS SIZES OF HEATERS X I F Y I F Z I F	NUMBER OF HEATERS REQUIRED
		49	28	40	1-40	1-40CA	20R 9' 16R 8' 14R 7'	1
		56	35	56	1-65		22R 9' 18R 8' 16R 8'	1
		63	42	72			22R 9' 18R 8' 16R 8'	1
		77	49	88	1-90	1-66 "	22R 9' 18R 8' 16R 6'	1
		84	56	102			24R 10' 22R 9' 18R 8'	1
		91	63	120	1-125	1-82 "	24R 10' 22R 9' 18R 8'	1
		98	70	136			26R 10' 24R 10' 20R 5'	1
		105	77	144	2-65		22R 9' 22R 9' 22R 9' 216R 6'	2
		112	84	160		1-100 "	22R 9' 22R 9' 22R 9' 216R 6'	2
		119	91	176			22R 9' 22R 9' 22R 9' 216R 6'	2
		126	98	192	2-90		22R 9' 22R 9' 22R 9' 216R 6'	2
		133	105	208		2-66 "	22R 9' 22R 9' 22R 9' 216R 6'	2
		140	112	224			22R 9' 22R 9' 22R 9' 216R 6'	2
		147	119	240			22R 9' 22R 9' 22R 9' 216R 6'	2
		154	126	256	2-125		22R 9' 22R 9' 22R 9' 216R 6'	2
		161	133	264			22R 9' 22R 9' 22R 9' 216R 6'	2
		168	140	280		2-82 "	32R 9' 32R 9' 316R 8'	3
		175	147	296	3-90		32R 9' 32R 9' 316R 8'	3

HEATERS IN COL. "X" ARE FOR OUTSIDE TEMPERATURES OF 20° F
 "Y" ARE FOR ZERO TEMPERATURES; AND "Z" FOR 20° ABOVE ZERO.
 "F" GIVES DIAMETER OF SMOKE PIPE.

FOR DETAILS SEE DRAWING G20-316

CONSTRUCTION DIVISION OF THE ARMY
 TYPICAL BUILDINGS
 MESS BUILDING

SB-15

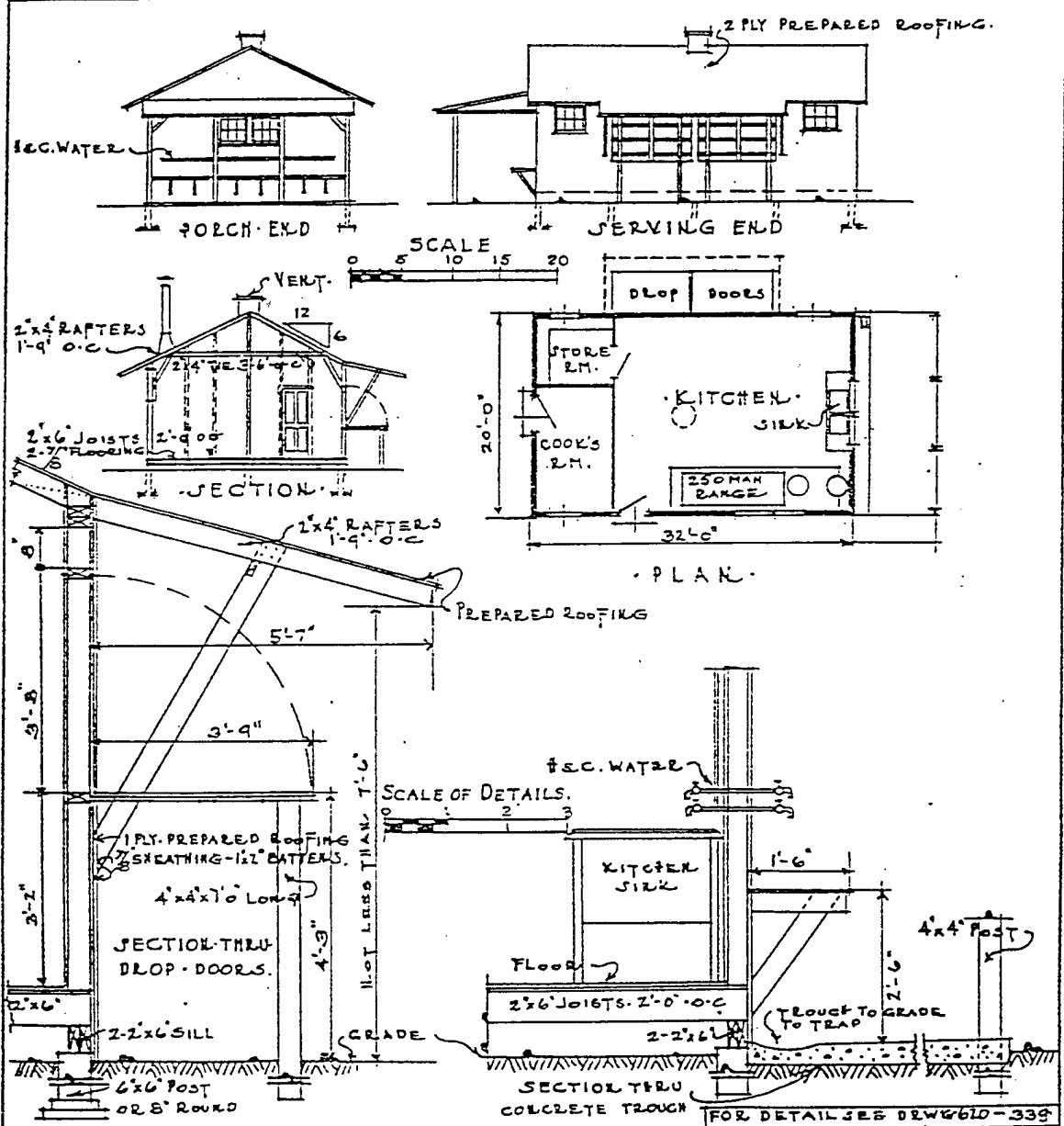
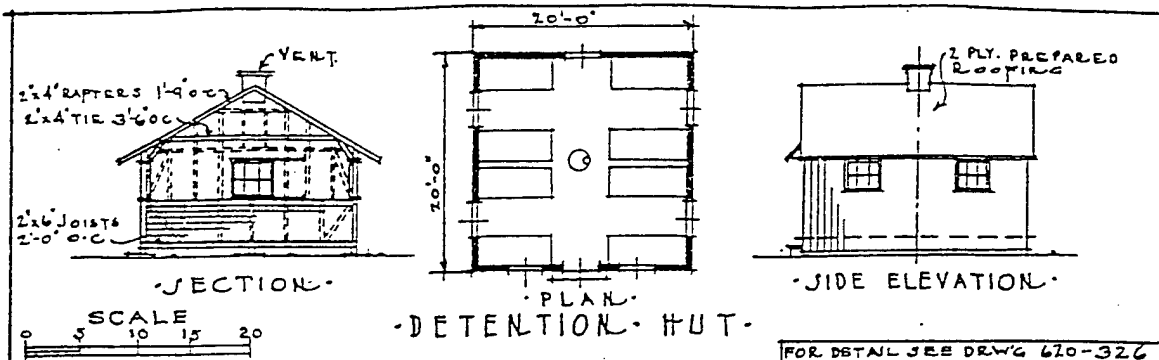

CONSTRUCTION DIVISION OF THE ARMY. SB-18
 • TYPICAL • BUILDINGS •
 DETENTION HUT & KITCHEN FOR DETENTION & QUARANTINE CAMPS.

15-6

PLAN FOR KITCHEN AND DINING ROOM 72 MEN

BILL OF MATERIAL

- 25 BBL'S. CEMENT
 - 8 CY. SAND
 - 8 CY. STONE
 - 24 POST PIERS
 - 12 Pcs. 4x4x14 SILLS
 - 5 - 4x4x16 STUDS & GIRTS
 - 30 - 2x4x16
 - 12 - 2x4x16 PLATES
 - 65 - 2x4x14 ROOF
 - 40 - 2x4x16
 - 5 - 2x6x12
 - 10 LBS ROOFING NAILS
 - 1 LB. TACKS
 - 20 Pcs. 2x4x16 LOUVERS AND CORNER BOARDS
 - 4000 FT. B.M. 8 SHIPLAP-16 FT. WALL & ROOF
 - 4 DOORS-2'6"x7'0" COMPLETE
 - 18 Sqs. RUBBEROID ROOFING
 - 23 Yds. 36" SCREENING
 - 10 GALS. COLD WATER PAINT
- 5 Pcs. 2x6x16 WINDOW SILLS
 - 8 - 1x12x16 SHELVES
 - 4 - 1x12x12
 - 2 - 1x12x10
 - 8 - 1x12x18 TABLES
 - 7 - 2x8x18
 - 21 - 2x4x16
 - 18 PR. HINGES
 - 18 HOOKS OR FASTNERS
 - 10 LBS. 6d NAILS
 - 75 - Bd.
 - 60 - 16d.
- LABOR-CARPENTER-26 HOURS
 CONCRETE LABOR-30 HOURS
 PAINTER-24 HOURS

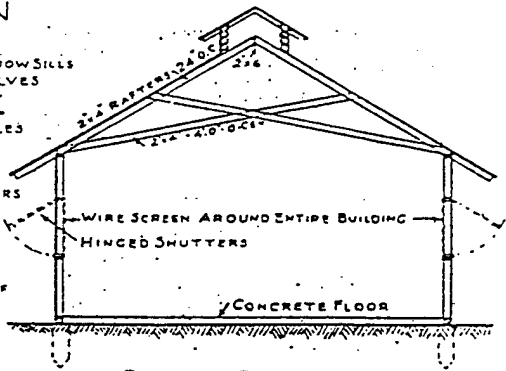

CROSS SECTION

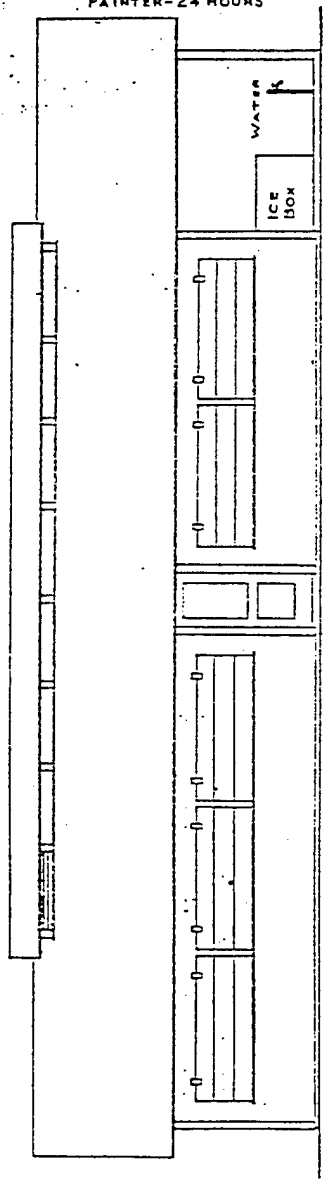

ELEVATION

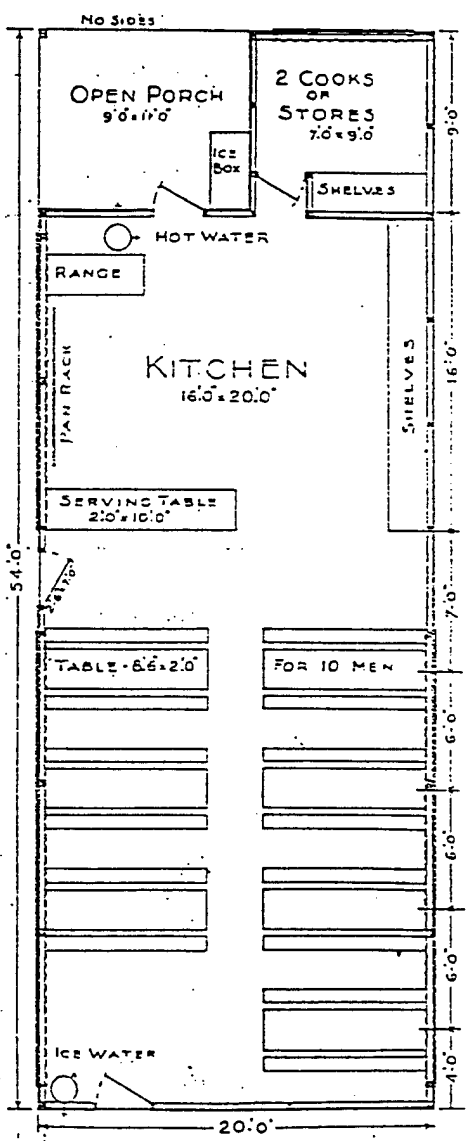

PLAN

SCHEDULE - BUILDINGS

Length of Buildings	Doors			Tables			Number of Men Seated
	Window	Door	Total	10 Seats	11 Seats	12 Seats	
20'	4		4		4		44
35'	5		5		4	1	56
42'	6		6		4	2	68
49'	7	1	8	4	4		84
56'	7	1	8	6	4		104
63'	8	1	9	6	4	1	116
70'	9	1	10	4	0		128
77'	9	2	11	10	4		144
84'	10	2	12	10	4	1	156
91'	11	2	13	0	0		168
98'	12	2	14	14	4		184

NOTE:

- All tables 3' x 10'.
- Each mess building to have 1 flue in addition to 1 for each door bent. All flues to be placed for best results.

MESS BUILDING

Scale in Feet

16-6

TEMPORARY BUILDINGS

FOR

MOBILIZATION CAMPS

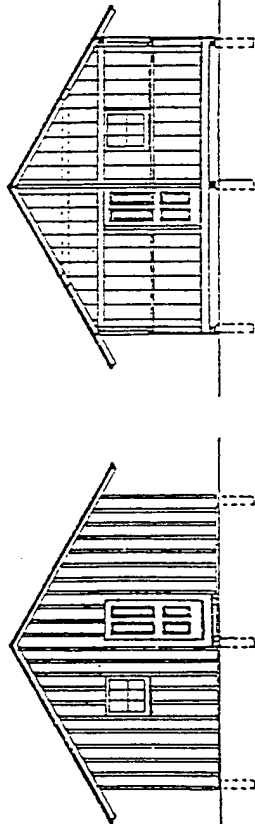

SECTION

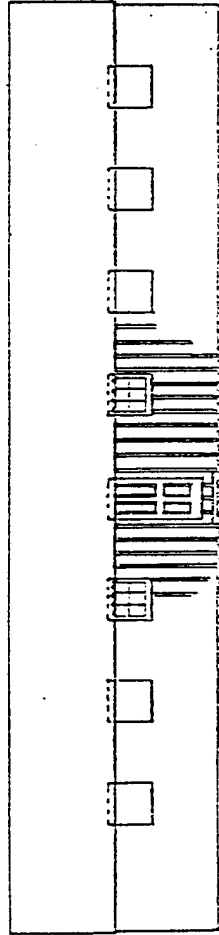

SIDE ELEVATION

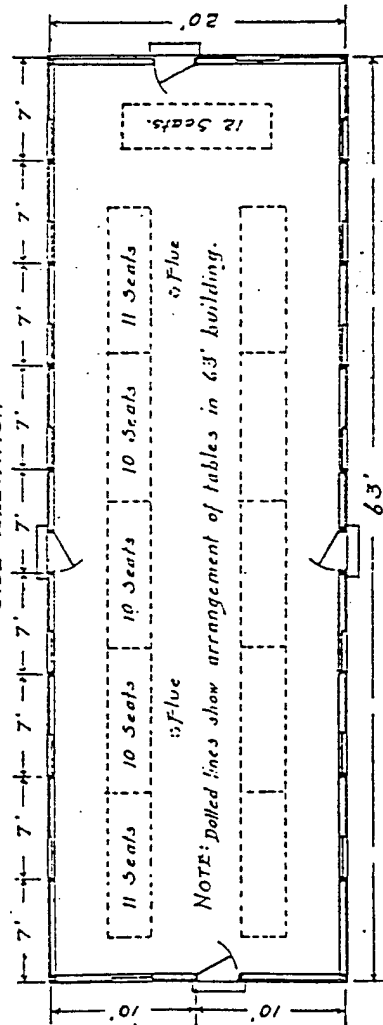

PLAN

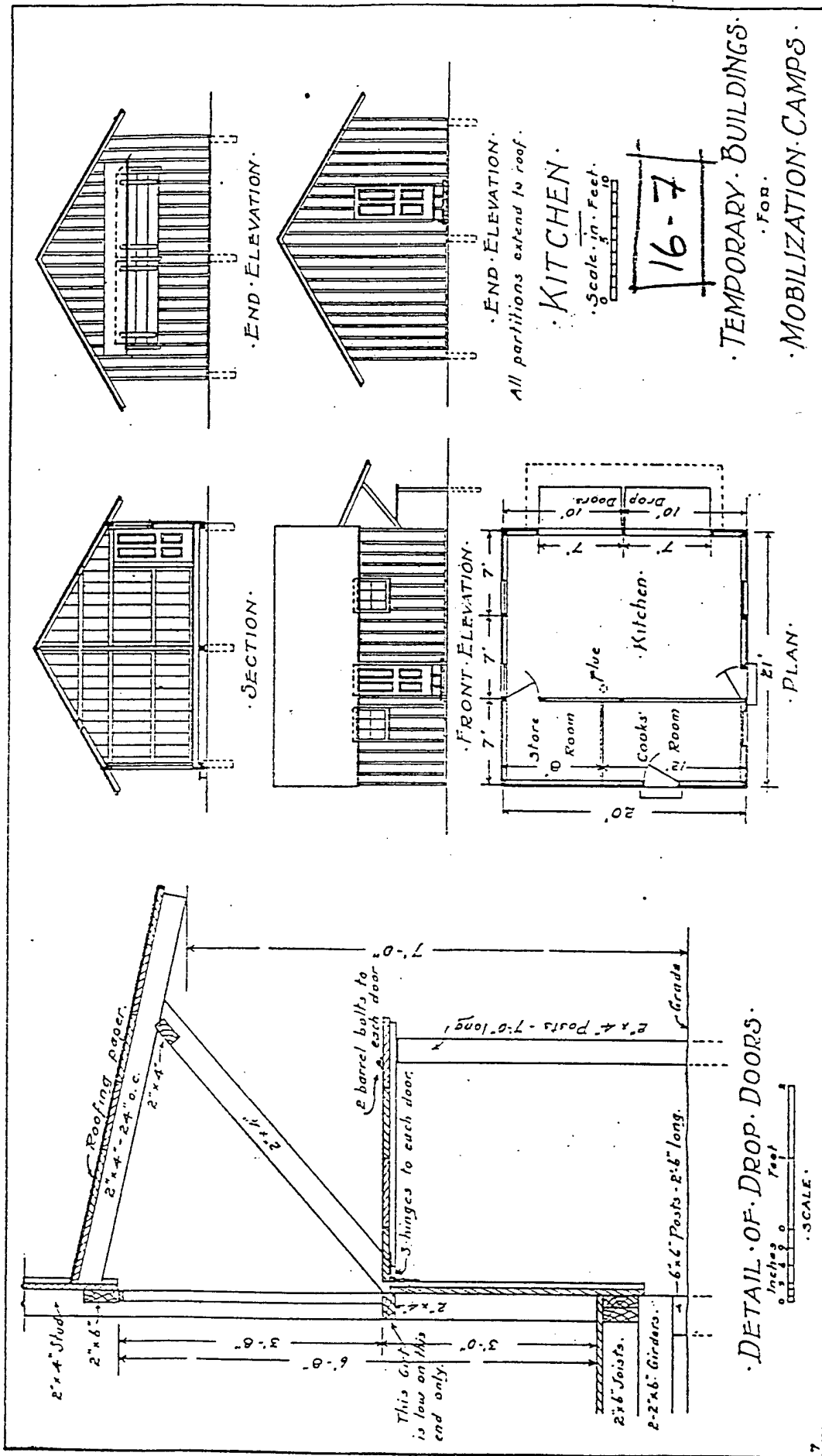

KITCHEN

16-7

TEMPORARY BUILDINGS
FOR
MOBILIZATION CAMPS

Category: RESIDENTIAL

Type 9 c-1: Family Housing: Non-Commissioned Officers (NCO) Housing

Description:

The military constructed family housing to serve married officers and non-commissioned officers. By the mid-twentieth century, the Army had developed a family housing program for non-commissioned officers, while the Navy discouraged enlisted personnel and even petty officers from marrying. Army family housing is stratified according to rank. Non-commissioned officers family housing was located in separate areas on Army posts apart from the officers housing area and the parade ground. The housing generally was designed as simpler versions of the predominant architecture of an installation.

Evolution:

The Army provided few quarters for family housing before the Civil War. Permanent barracks and officer housing was constructed at installations, such as coastal fortifications, armament factories, education facilities, and some western posts, intended for use over several years. Non-commissioned officers typically were assigned single rooms within the enlisted men's barracks. Detached houses for non-commissioned officers and their families were not constructed until the second half of the nineteenth century. While the Army tolerated NCO marriages before 1940, it actively discouraged and even prohibited enlisted men from marrying until World War II.

NCO family housing was first provided for specific senior NCOs. The earliest examples included houses for the commissary sergeant, the ordnance sergeant, or the quartermaster sergeant. Early NCO quarters were constructed cheaply of available materials, such as the one-story, frame housing at Ft. Sill, Oklahoma. Other examples were constructed as simpler versions of the installation officer housing. In 1888, Congress approved budget allowances for the construction of hospital stewards quarters. Before this time, hospital stewards had lived in a room in the hospital building.¹⁵ After 1888, hospital stewards quarters were a typical component of hospital complexes on Army posts.

The Army made no systematic effort to provide standardized housing for noncommissioned officers before the 1880s. Plans for NCO housing were not included in the proposed 1860 regulations or in the 1872 proposed Quartermaster plans. The families of enlisted men found housing through a variety of expedients. The soldiers' wives who were employed as laundresses lived in a row of shacks. Other families divided unused barracks buildings into housing areas. As officer housing was improved, enlisted men and their families moved into abandoned officer quarters.¹⁶

¹⁵ Bethanie C. Grashof, *A Study of United States Army Family Housing Standardized Plans 1866 1940*, Vol. 1, Atlanta: Georgia Institute of Technology, 1986, 19-20.

¹⁶ Frank N. Schubert, *Ft. Robinson, Nebraska, the History of a Military Community*, Ph.D. diss., University of Toledo, 1976, 66-73.

The Army began to include permanent housing for senior NCOs at the larger consolidated installations constructed starting in the 1880s through the turn-of-the-century. The Quartermaster Department also began to develop standardized plans for NCO housing at this time. The Quartermaster Department built both detached single-family and duplex NCO housing. Duplexes were the most common housing type for NCOs between 1890 and World War I. Most installations during this era had no more than approximately half a dozen houses for NCOs and their families. NCO housing was located next to the area where the resident NCO worked. For example, the hospital steward's house was built next to the hospital. NCO housing was also constructed in distinct NCO housing areas, usually a few hundred feet behind the barracks. NCO housing in barracks areas typically consisted of a row of three to five houses. Unlike the barracks and officers quarters, NCO housing was not located around the parade ground.

During the 1920s, the Army suffered from a severe nationwide housing shortage. After a Congressional investigation into the living conditions at dilapidated World War I mobilization camps, Congress enacted Public Law 45 in 1926, which allowed the Army to dispose of unneeded property and to use the funds to improve the posts it retained. The initial funds were directed specifically for the construction of hospitals, barracks, and NCO housing. During this period of inter-war construction, the Army built more NCO family housing than ever before in its history.

The installation construction funded by this new program incorporated the ideas of city planning through the organization of the component parts of the installation into distinct hierarchical areas within an overall plan. A planner with the Planning Branch of the Quartermaster Corps compared the NCO housing area to the "office worker area" of a city.¹⁷ NCO family housing areas now constituted entire neighborhoods within increasingly large and complex installation plans. The Construction Service of the Quartermaster Corps developed standardized plans for NCO family housing that were comparable to small civilian suburban cottages and bungalows of the same era. The plans followed regional architectural styles, particularly the Spanish Colonial and Georgian Colonial Revival. The Army generally constructed the Georgian Colonial Revival from the Mid-Atlantic north to New England and west to the Northwest; the Spanish Colonial style housing was constructed in the hotter climates of the Southeast and Southwest. Two-story duplex NCO quarters remained popular, and one-story single-family cottages were introduced.

Association:

Non-commissioned officers quarters are associated with the maintenance of a standing Army and with the evolution of living standards for military personnel. The construction of non-commissioned officer housing directly reflects the history and status of the military during their period of construction. Non-commissioned officer housing provides an insight into the hierarchy of the military and contributes to cantonment historic districts. The design of non-commissioned officer housing reflects the influence of civilian architecture on military designs. NCO quarters

¹⁷ E. Mack Hallauer, "Landscaping the Army Post", *The Quartermaster Review*, July-August 1939, 28-31.

often are contributing elements in an installation historic district, or may constitute a distinct historic district. NCO quarters also may possess individual significance if it embodies the distinctive characteristics of a type or period of construction.

Integrity:

To possess integrity, non-commissioned officer housing should retain its location and most of its design, setting, materials, workmanship, and association from the period of significance of the property. Most NCO quarters have been used as dwellings throughout their history. The buildings often have undergone modifications to meet modern living standards. Typically modified exterior features include porches, windows, and roof materials. In cases of subsequent additions or alterations, NCO housing still may have integrity if it retains its setting, overall design, the majority of its materials, and the majority of its architectural features.



1930's NCO Quarters at Aberdeen Proving Ground, MD

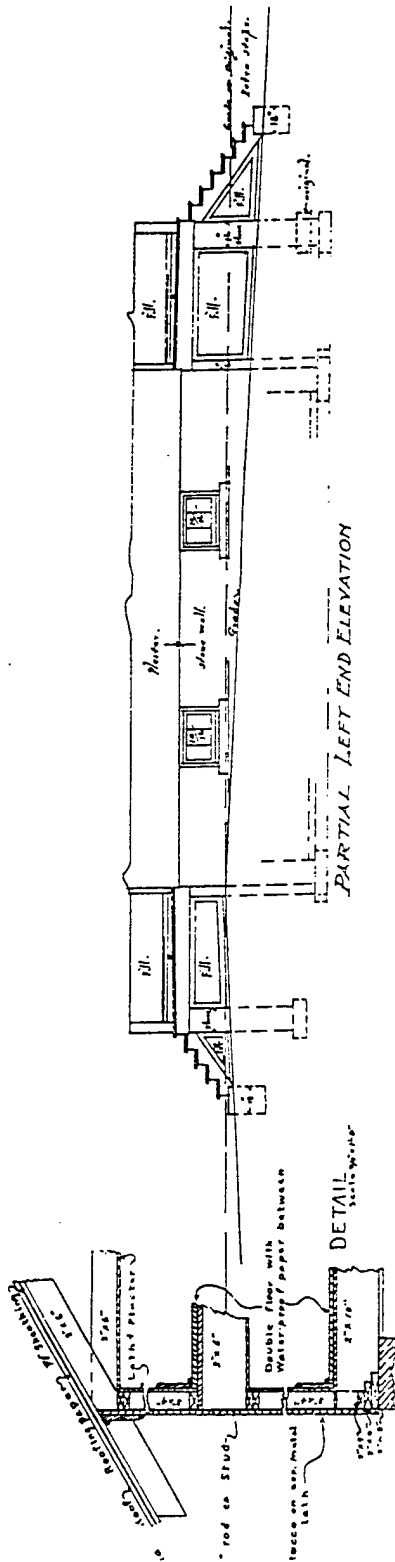

PARTIAL LEFT END ELEVATION

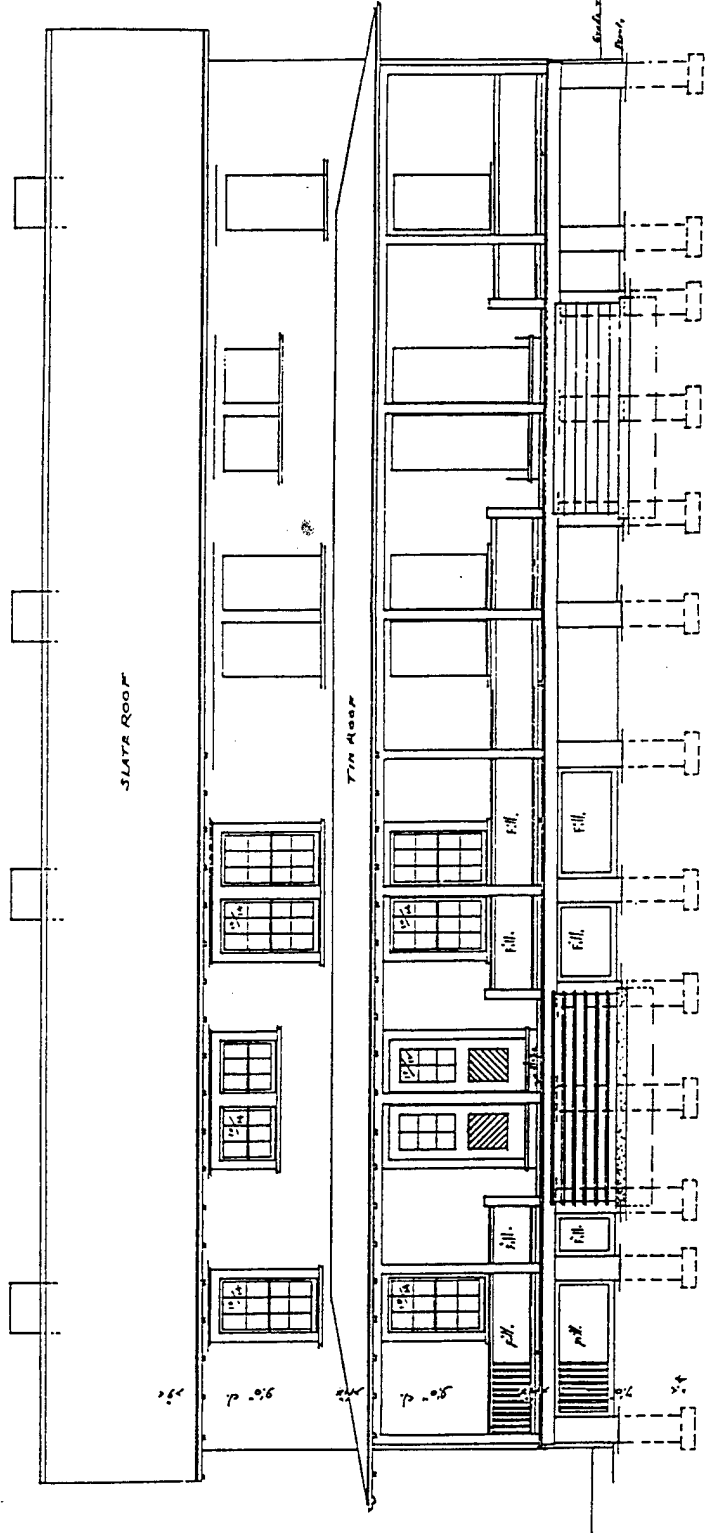

FRONT ELEVATION
SCALE 1/4" = 1'-0"

SHOWING CHANGES IN GRABES, FOUNDATIONS, ETC.

FOUR SET. CIVILIANS QRS.
FORT RILEY KANS.
OFFICE CON. Q.M. SEPT. 1909.
REVISED AND REDESIGNED.

B.L.D.C. # 189 Sheet-1
V File A 2-16
10159-B1CT

JUR

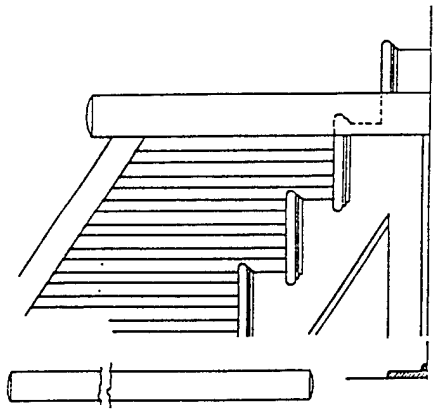

DETAIL - B - STAIRS
SCALE: 1/8" = 1'-0"

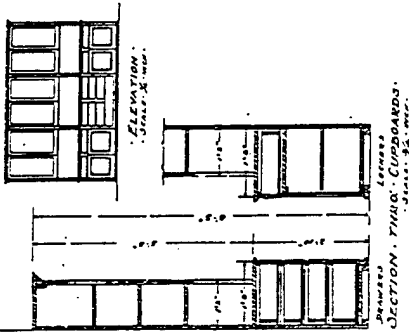

SECTION - WINDOW - CUPBOARDS
SCALE: 1/8" = 1'-0"

DETAIL - A - PORCH
SCALE: 1/8" = 1'-0"

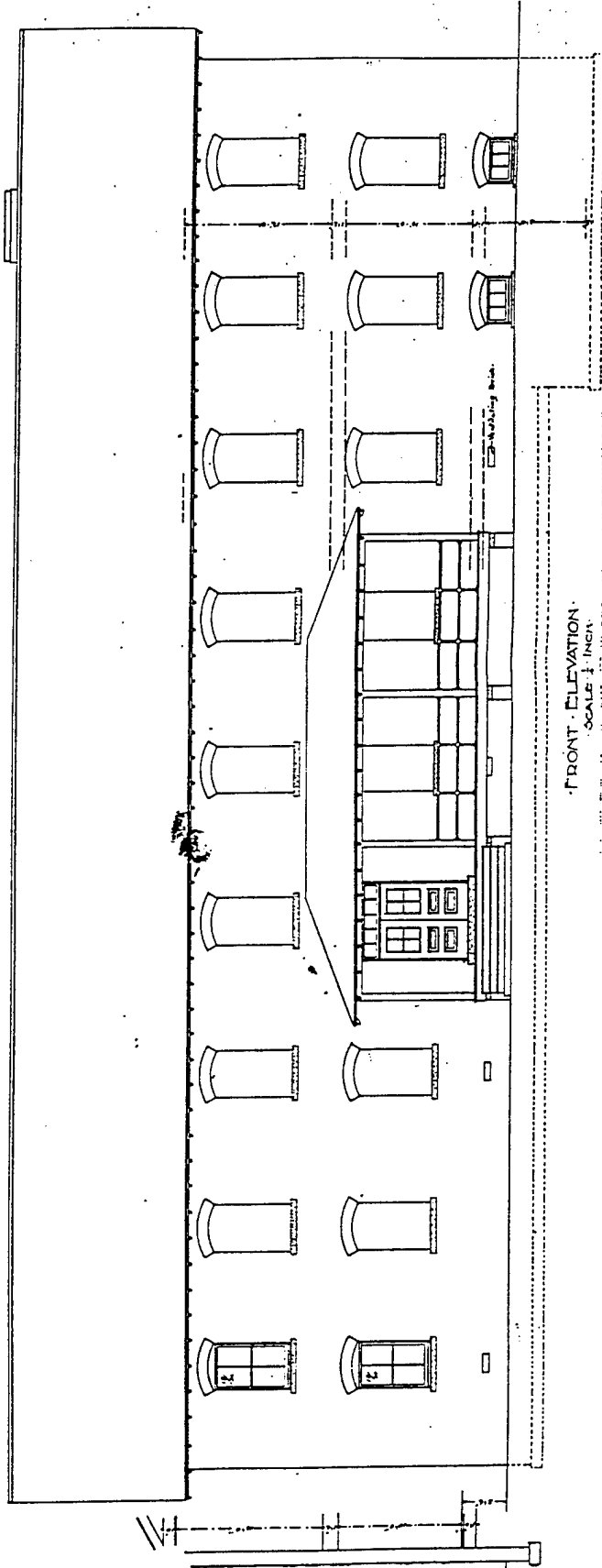
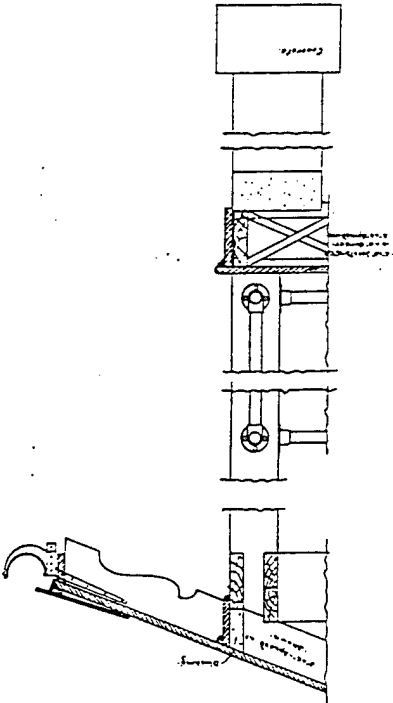

FRONT ELEVATION
SCALE: 1/8" = 1'-0"

SHEET No 4. 256

CONSTRUCTION SHEETS
STANDARD SHEET 14 x 22

QUARTERS FOR
CIVILIAN EMPLOYEES

HO 330-04.cit Q.M.G.O. JULY 1909

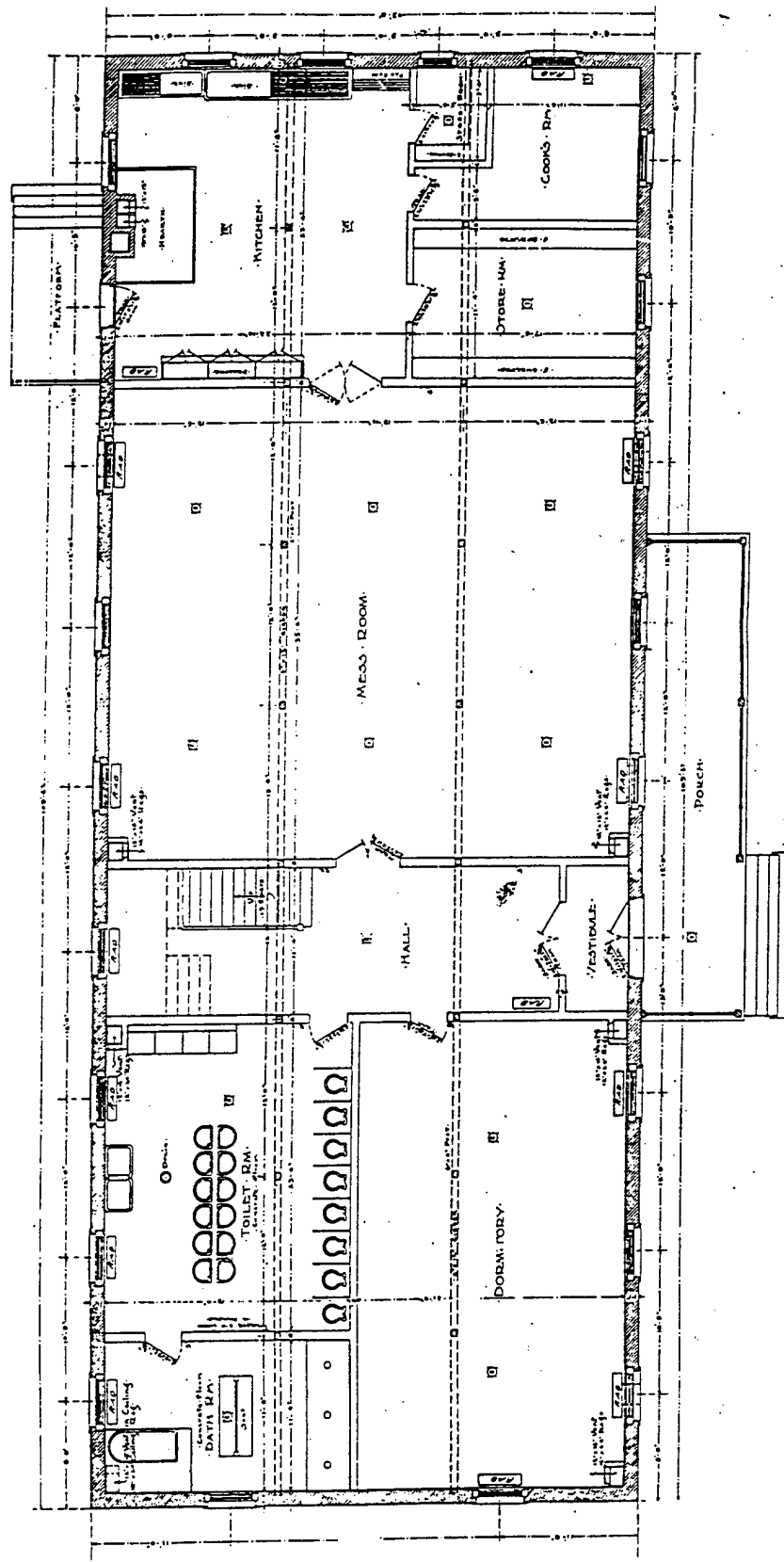

SHEET NO. 2. 256.
 CONSTRUCTION SHEET
 CIVILIAN EMPLOYEES
 Q.M.G.O. JULY, 1909.
 NO. 330-02.CIT

PLAN OF FIRST FLOOR.
 SCALE 1/4" = 1'-0"

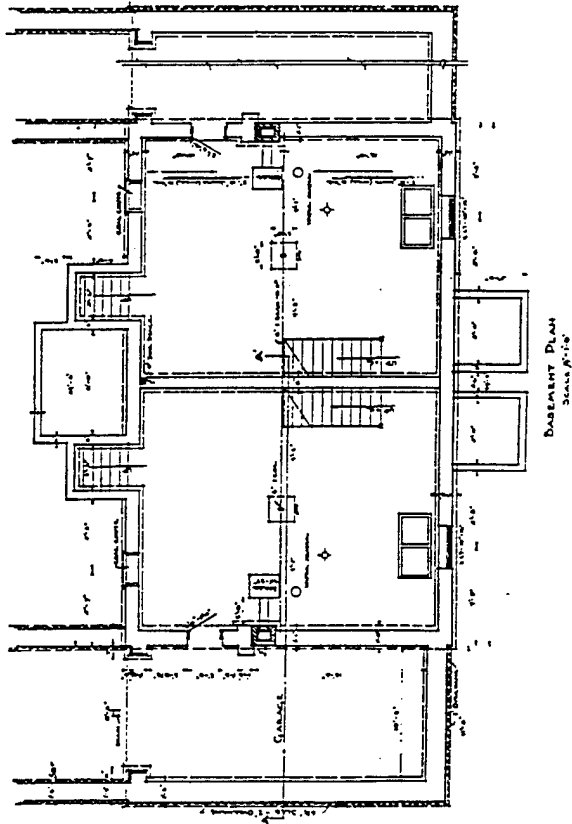
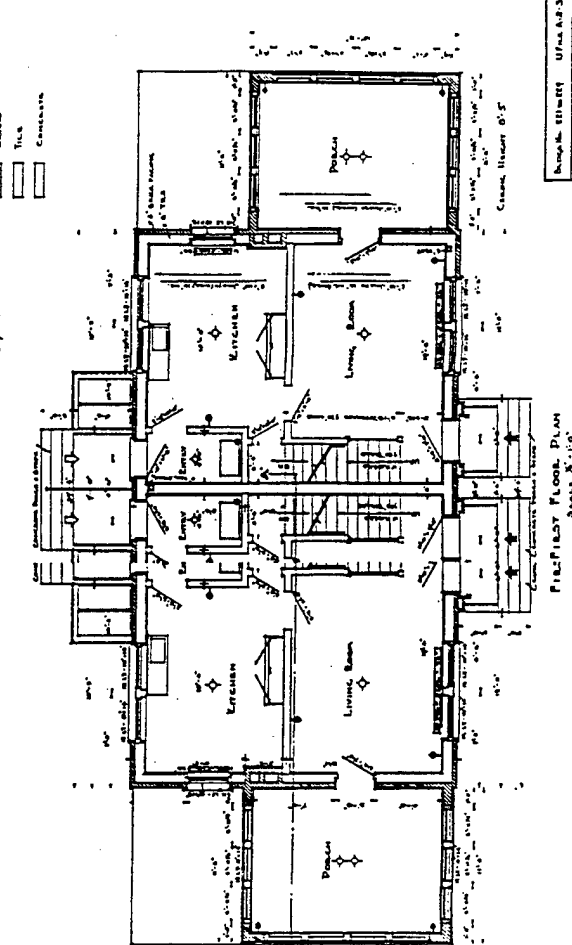
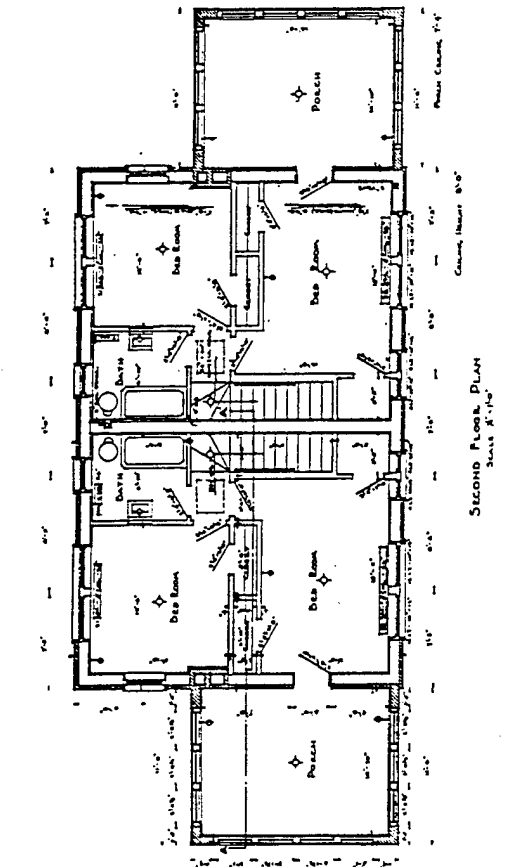
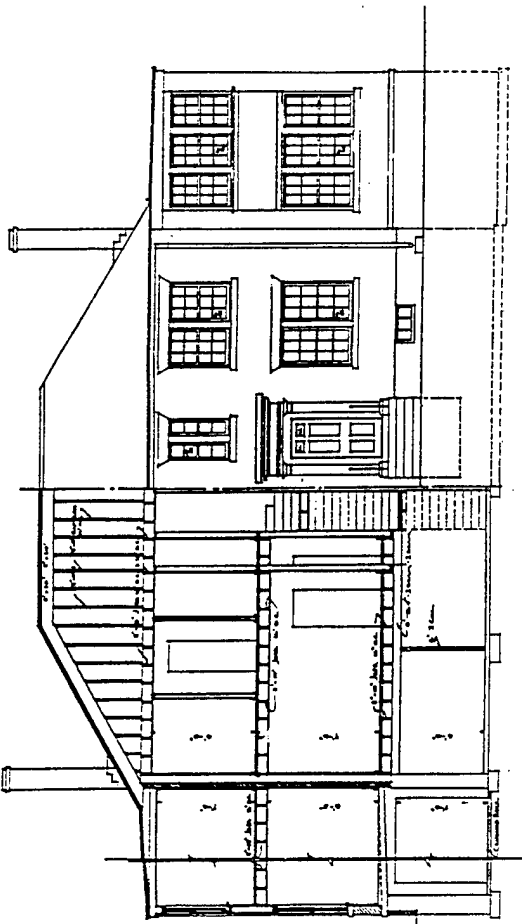

Project Number	UFA 415-3
Office of the Quartermaster	
Drawn by	J. H. [unclear]
Checked by	[unclear]
Approved by	[unclear]
Date	June 1951
Sheet No.	UFA 415-3-1
Project Name	UFA 415-3

NO 415-01.C11

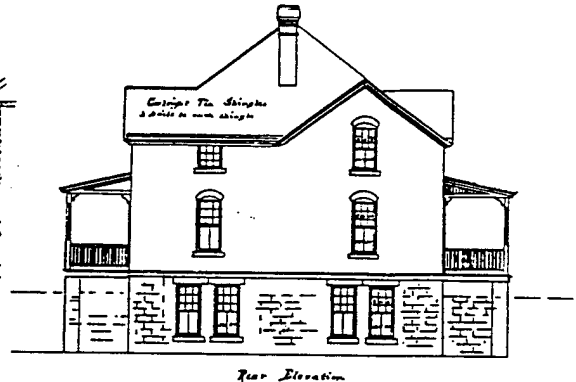
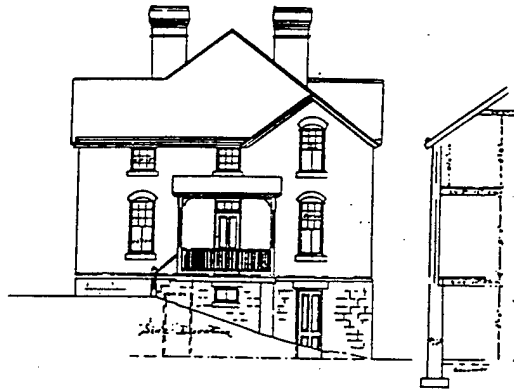

Rear Elevation

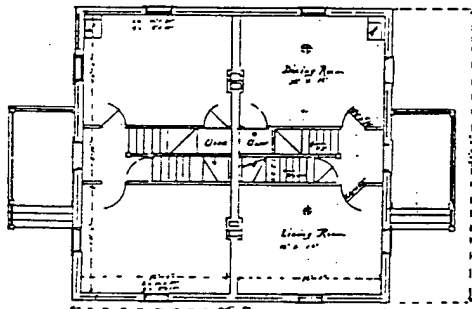

First Floor

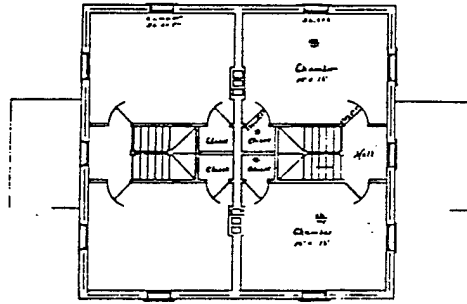

Second Floor

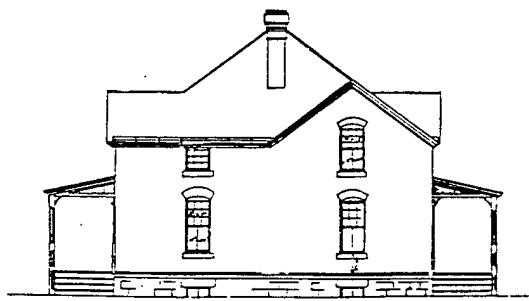

Front Elevation

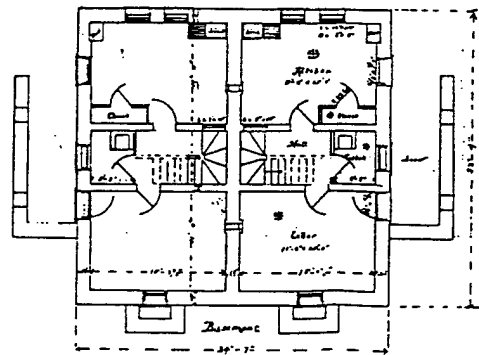

Basement

Non-Commissioned Officers Quarters
at
Fort Riley Kans Scale 1/8" = 1'

Quarters marked as designed by
Commissioned Engineer
Sheet-1
U File A 2-10

- 165

MB165_01.C17

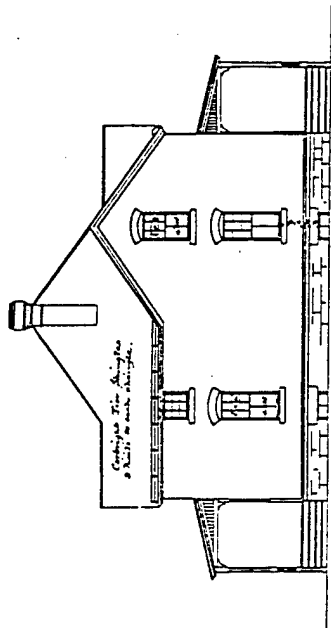

Front Elevation

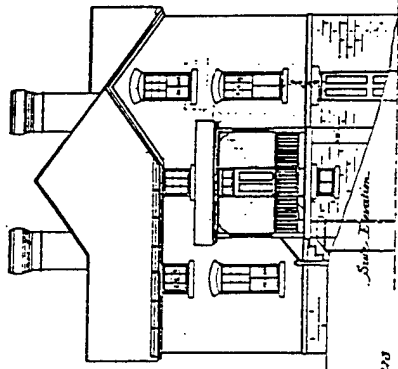

Side Elevation

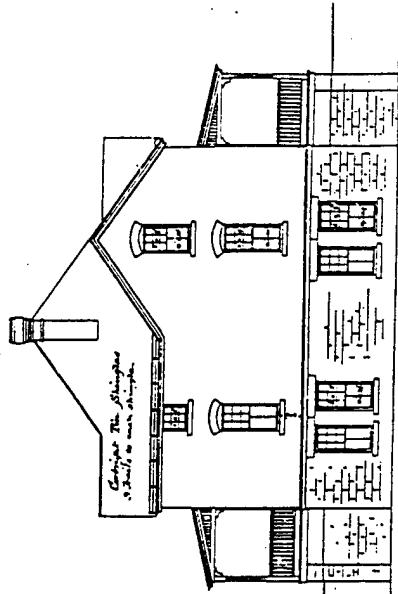

Rear Elevation

Non-Commissioned Officers Quarters

at

Fort Riley, Kans.

Capt. Geo. E. B. ...

APR 1915

Scale 1/8" = 1'

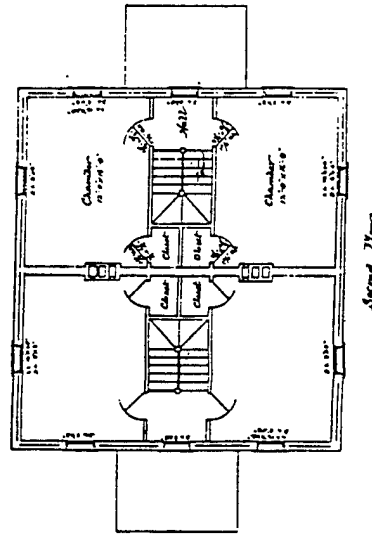
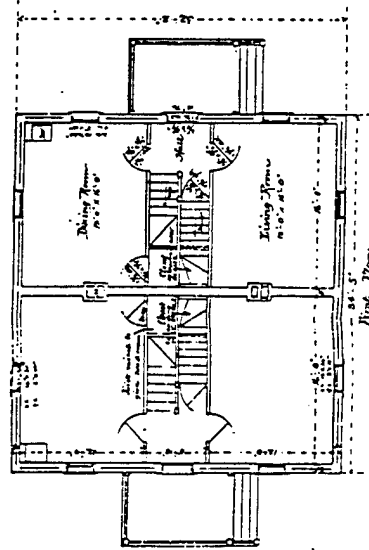
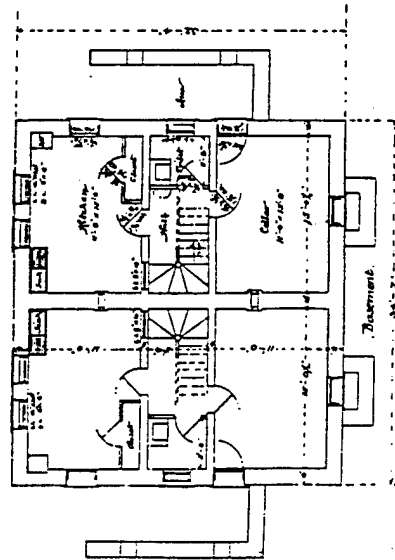

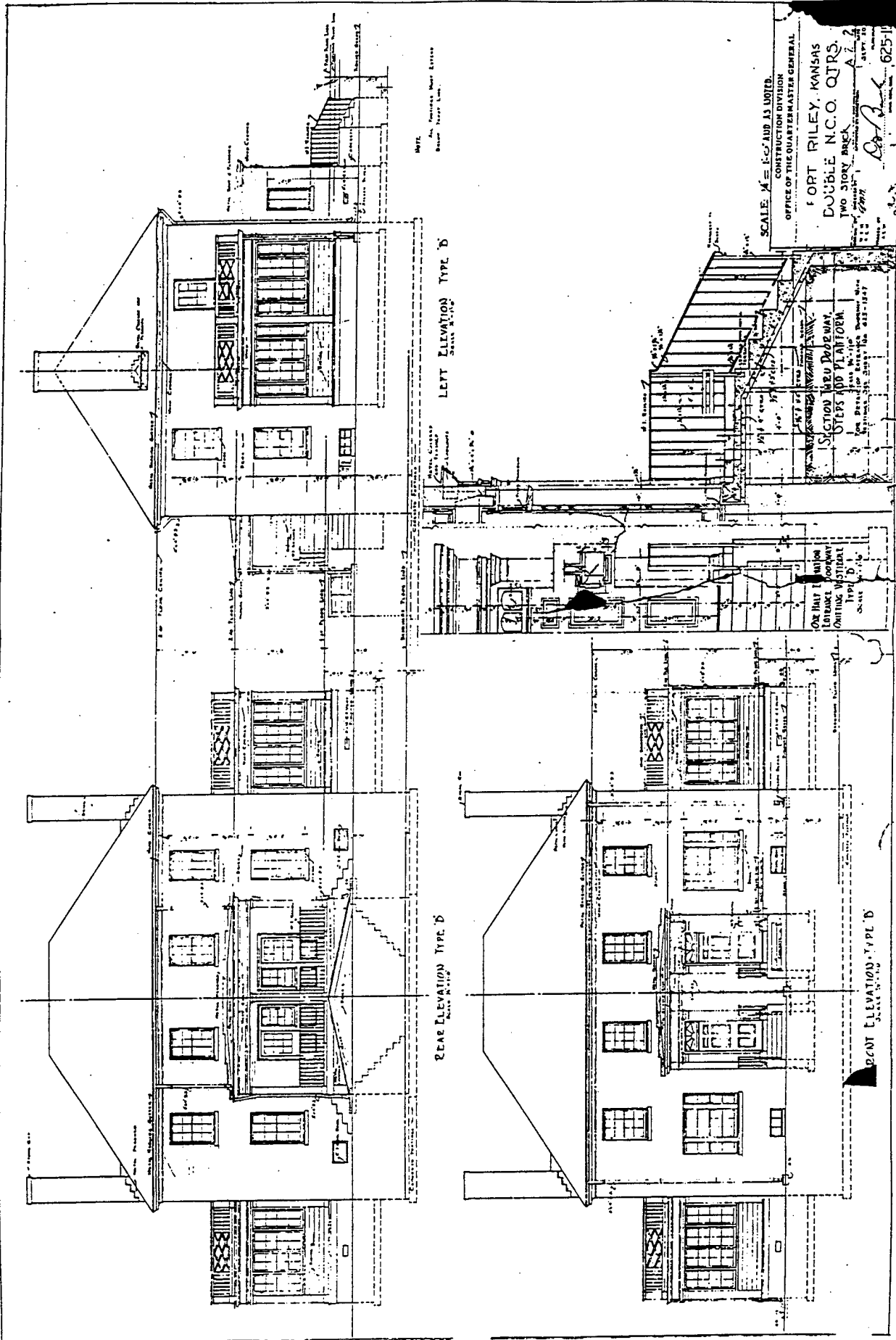

SCALE: 1/4" = 1'-0" AND 1/8" = 1'-0"

CONSTRUCTION DIVISION
OFFICE OF THE QUARTERMASTER GENERAL

FORT RILEY, KANSAS
DOUBLE N.C.O. QTRS.
TWO STORY BRICK

DATE: 1/27/1917
BY: [Signature]
NO. 625-11

LEFT ELEVATION TYPE D

REAR ELEVATION TYPE D

FRONT ELEVATION TYPE D

SECTION NEW DRIVEWAY
STEPS AND PLATFORM

ONE HALF INCH
ENTRANCE PORCHWAY
ENTRANCE VESTIBULE
TYPE D

NOTE:
REAR PORCH - 10' x 10'
FRONT PORCH - 10' x 10'

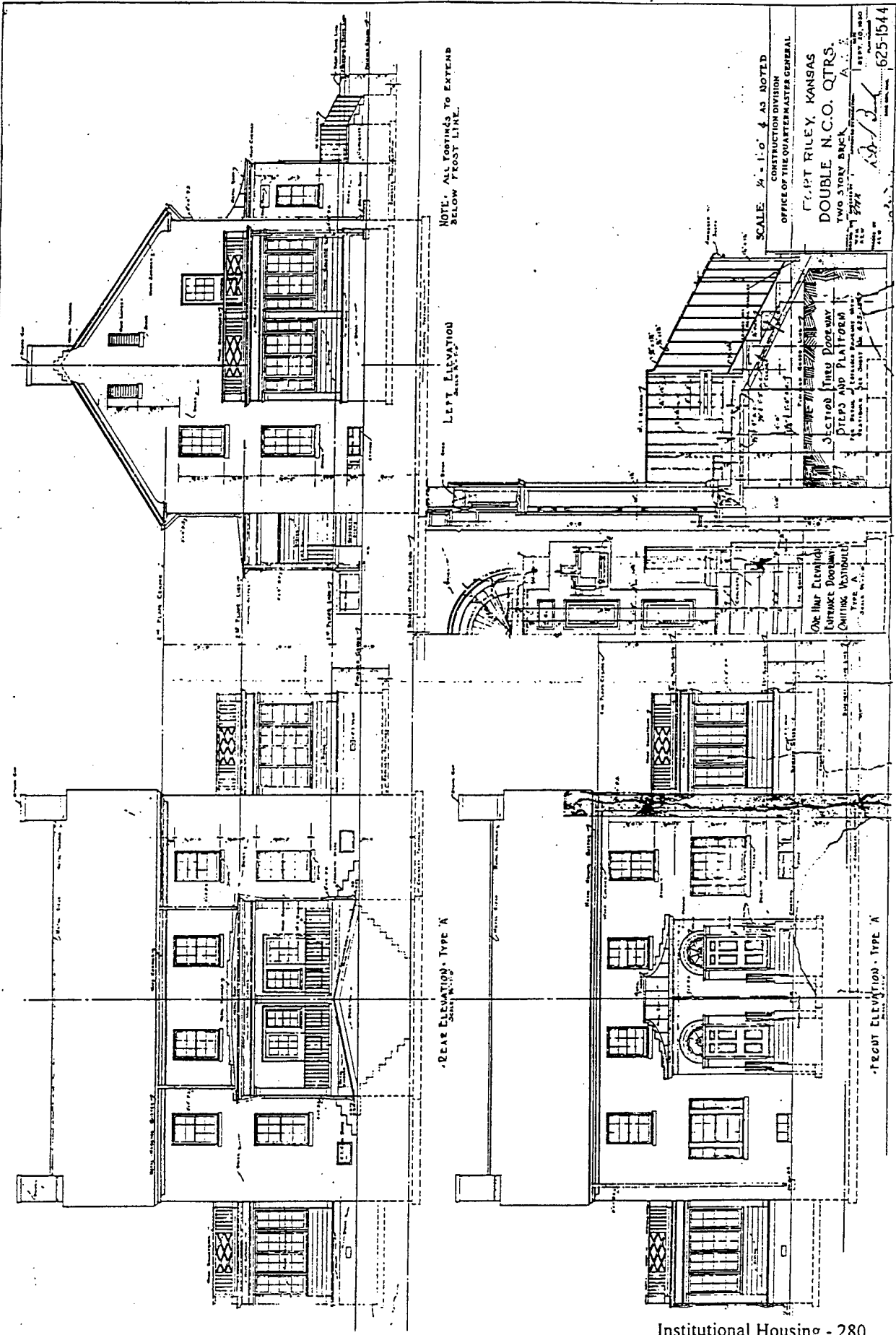

NOTE: ALL FOOTINGS TO EXTEND BELOW FROST LINE.

LEFT ELEVATION

REAR ELEVATION - TYPE 'A'

FRONT ELEVATION - TYPE 'A'

SCALE: $\frac{1}{4}'' = 1'-0''$ AS NOTED
 CONSTRUCTION DIVISION
 OFFICE OF THE QUARTERMASTER GENERAL
 CAPT RILEY KANSAS
 DOUBLE N.C.O. QTRS.
 TWO STORY BRICK
 A. S. S.
 1227 7th St. Kansas City, Mo.
 137-138
 625-1544

SECTION THRU DOORWAY
 STEPS AND PLATFORM
 ONE INCH ELEVATION
 ENTRANCE DOORWAY
 CHAIRING WOODBOLT
 TYPE 'A'

NO 157.02.c1

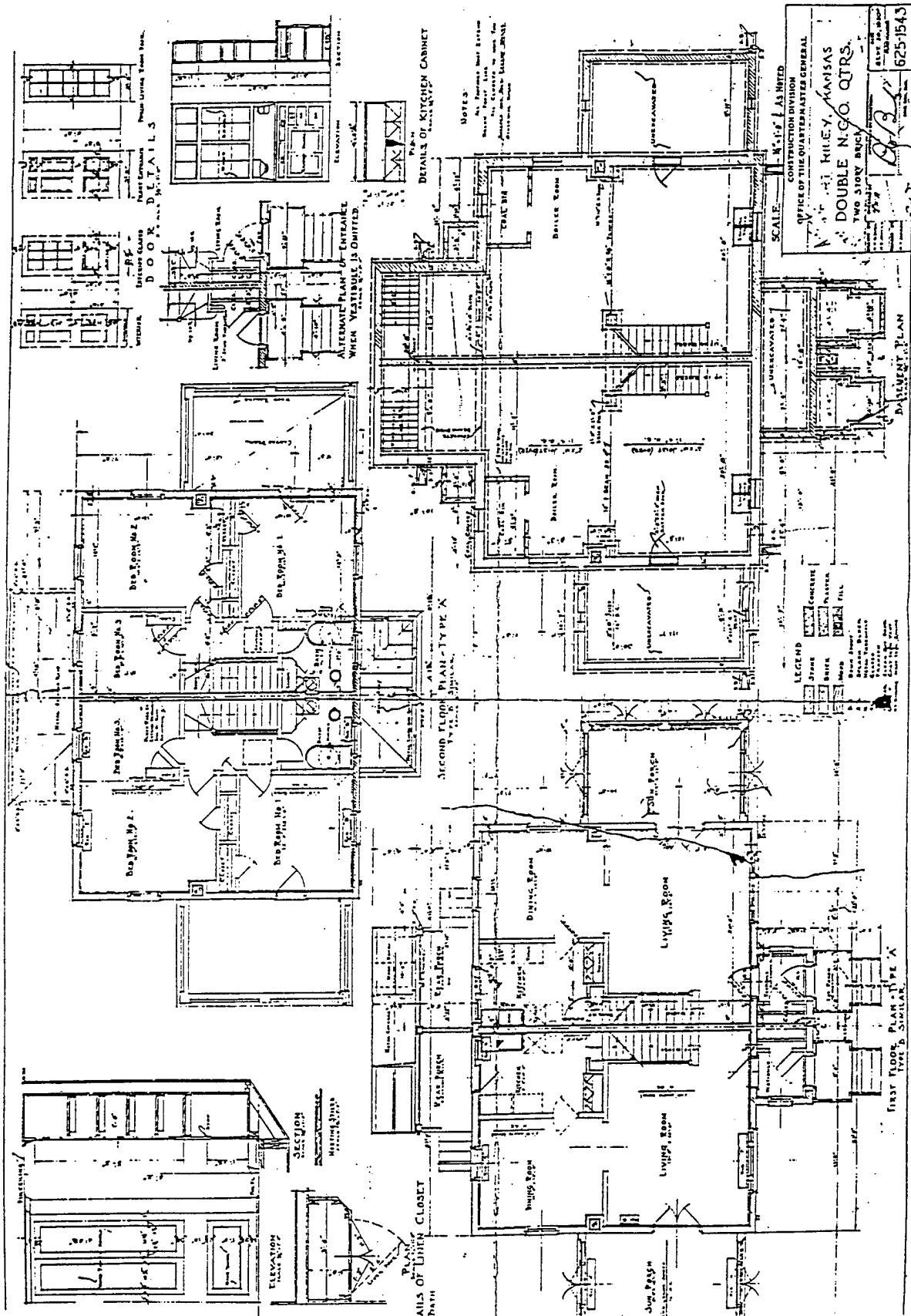

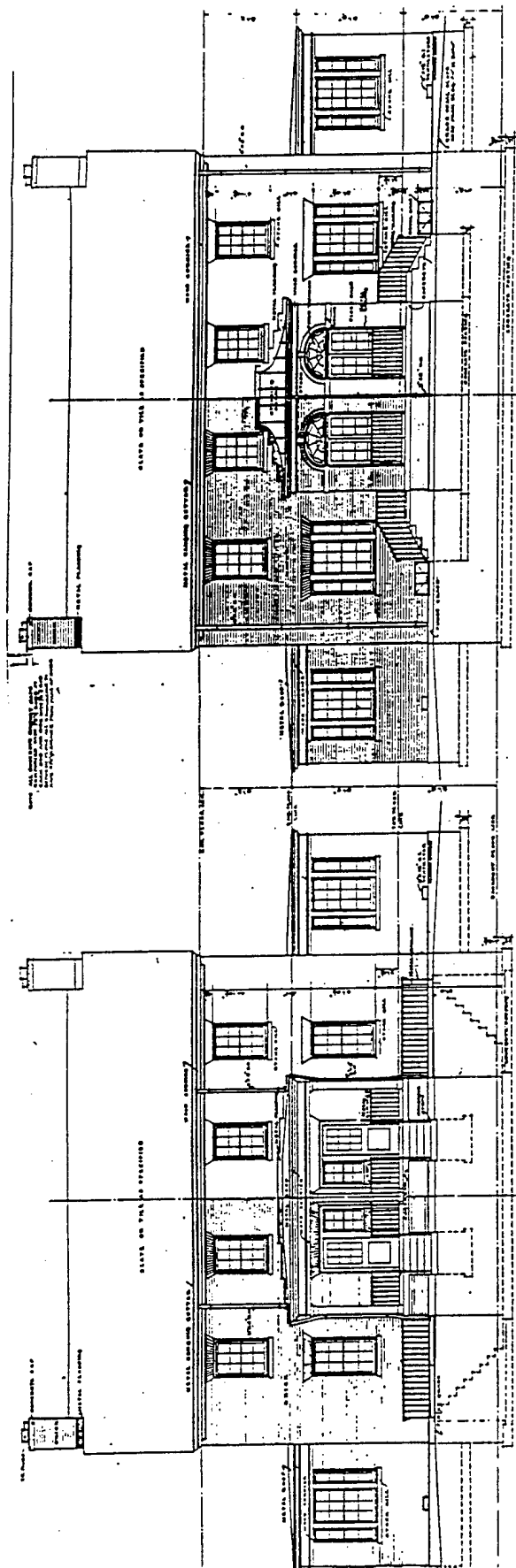

FRONT ELEVATION TYPE A

REAR ELEVATION TYPE A

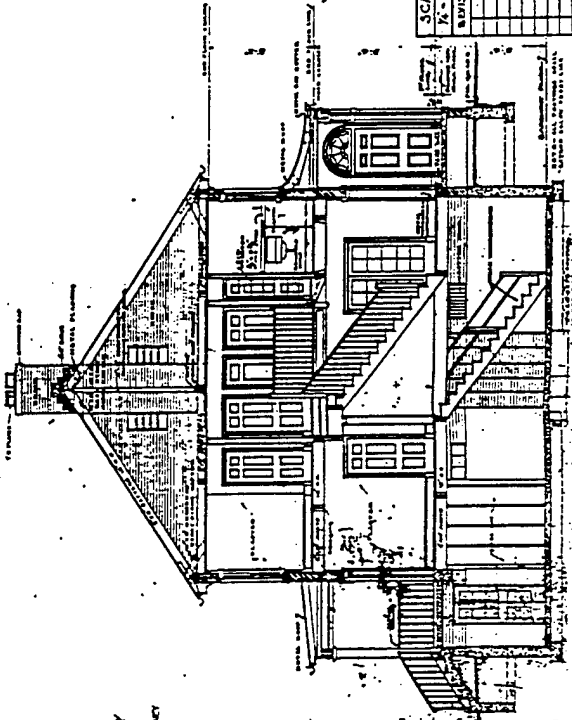

SECTION THROUGH HOUSE

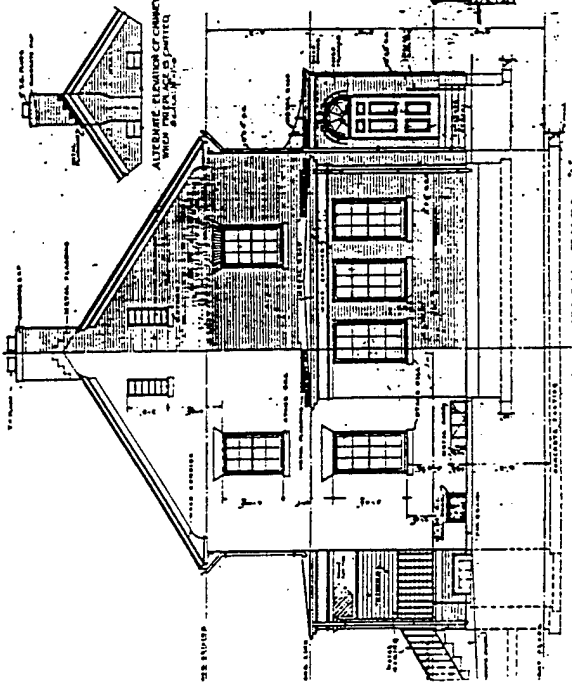

LEFT SIDE ELEVATION TYPE A

321-3-3-1 1-2-5

SCALE	CONSTRUCTION DIVISION
1/2" = 1'-0"	OFFICE OF THE QUARTERMASTER GENERAL
EDUCATIONS	
	PORT RILEY, KANSAS
	DOUBLE RILEY, KANSAS
	ELEVATIONS TYPE A
	ELEVATIONS TYPE A
	TWO STORY BRICK
	MAY 2, 1936
	625-3571

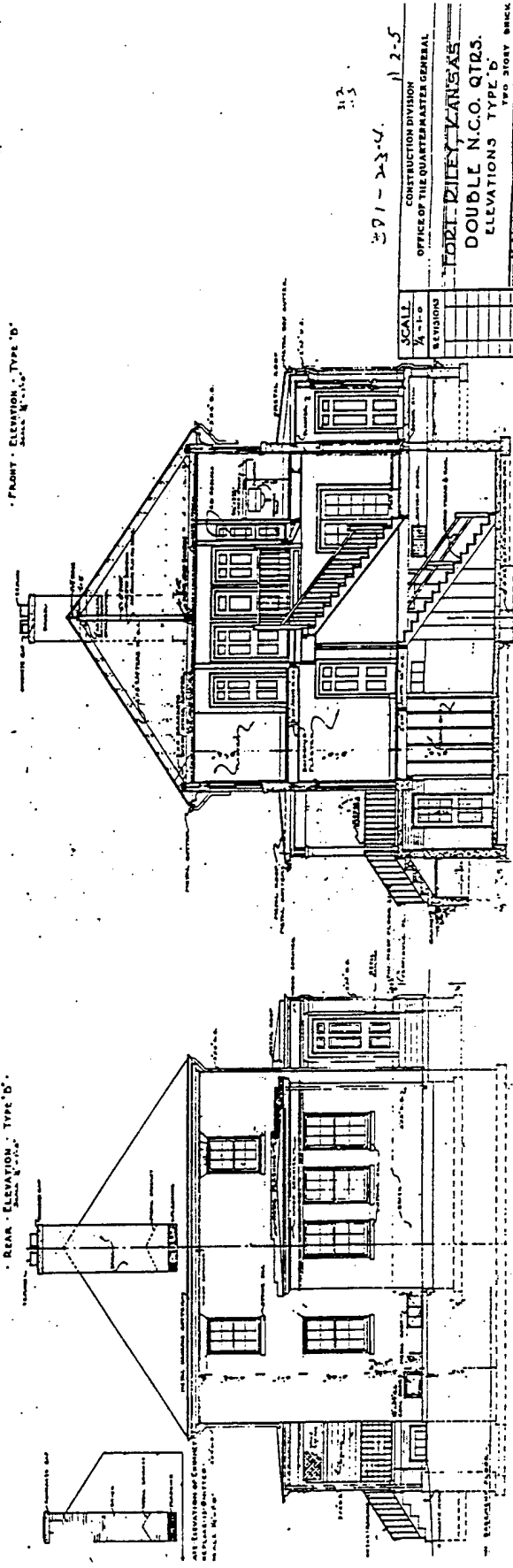
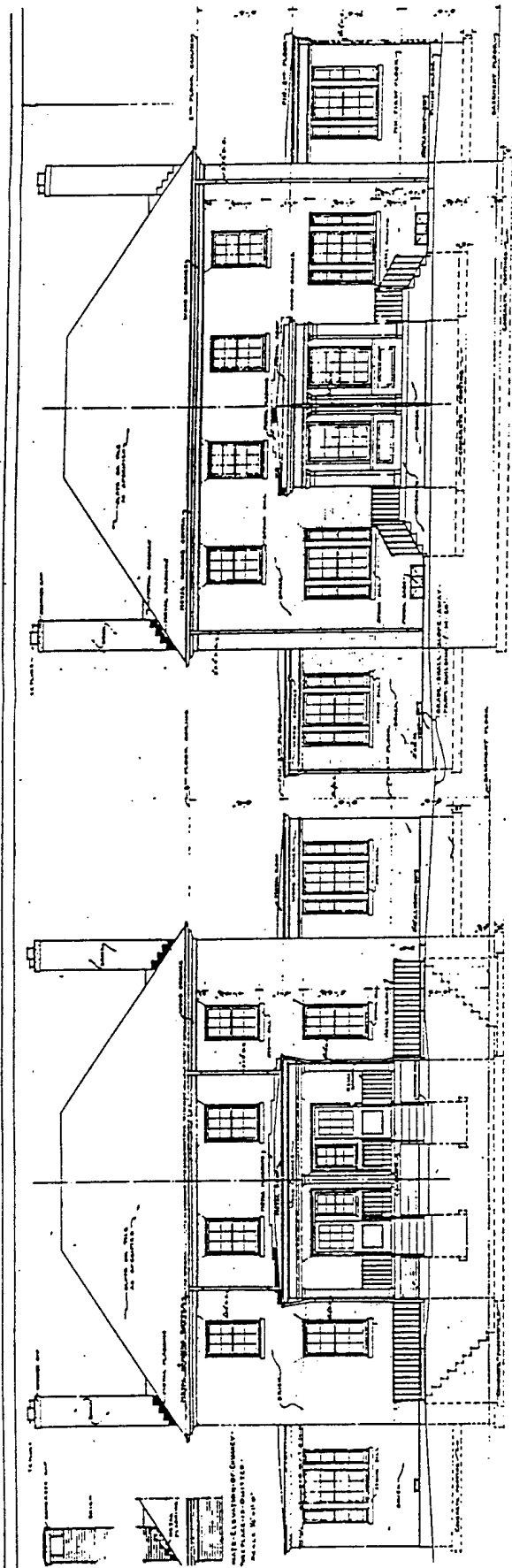

391-23-4 11-2-5

CONSTRUCTION DIVISION
OFFICE OF THE QUARTERMASTER GENERAL

FORT WILEY, KANSAS
DOUBLE N.C.O. QTRS.
ELEVATIONS TYPE B

SCALE
1/4" = 1'-0"
EXCEPTIONS

NO. 665-3572

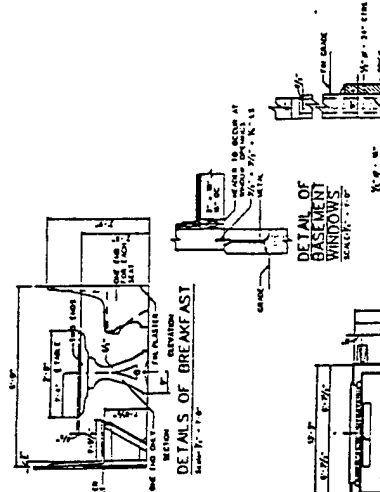

DETAILS OF BREAKFAST
NOOK

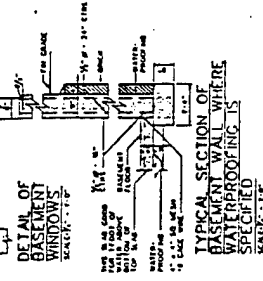

TYPICAL SECTION OF
BASEMENT WALL WHERE
SEVERAL FOOTINGS IS
REQUIRED

DOOR SCHEDULE

1	3'-0" x 6'-0"
2	3'-0" x 6'-0"
3	3'-0" x 6'-0"
4	3'-0" x 6'-0"
5	3'-0" x 6'-0"
6	3'-0" x 6'-0"
7	3'-0" x 6'-0"
8	3'-0" x 6'-0"

- CONCRETE
- BRICK
- STONE
- GLASS
- WOOD PARTITION
- WOOD SHUTTER
- WOOD SHUTTER
- WOOD SHUTTER
- WOOD SHUTTER
- WOOD SHUTTER
- WOOD SHUTTER
- WOOD SHUTTER
- WOOD SHUTTER
- WOOD SHUTTER
- WOOD SHUTTER

SCALE: 1/4" = 1'-0"
 DRAWING FOR THE RECORD
 PROJECT NO. 111-10-100
 N.C.D. QUARTERS
 11/1/50

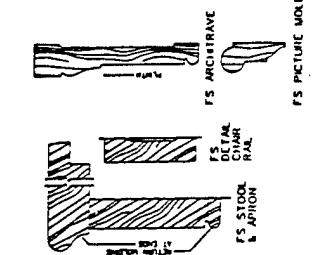

FS ARCHITRAVE
FS PICTURE MOLD
FS DETAIL
FS STOOL & APRON

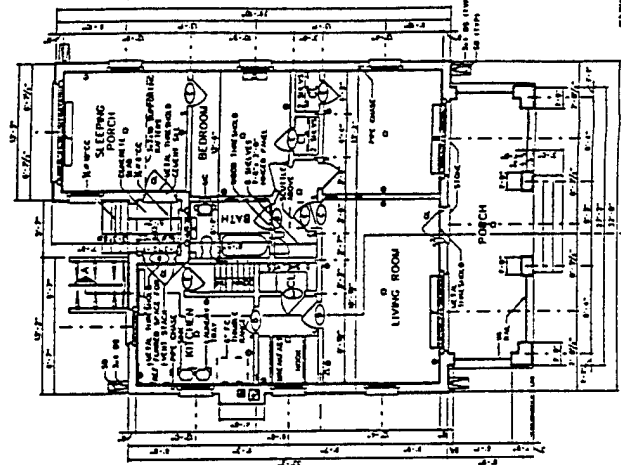

FIRST FLOOR PLAN
SCALE: 1/4" = 1'-0"

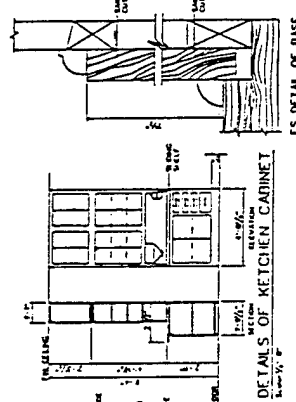

FS DETAIL OF BASE
DETAILS OF KITCHEN CABINET

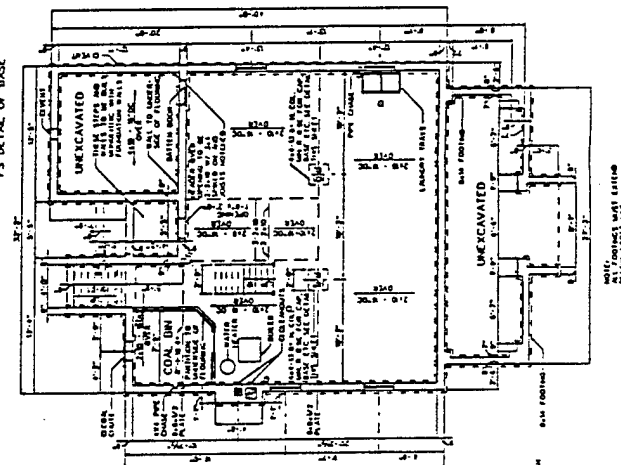

BASEMENT FLOOR PLAN
SCALE: 1/4" = 1'-0"

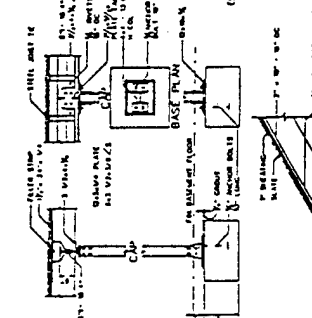

SECTION
DETAIL OF SPLASH BLOCK

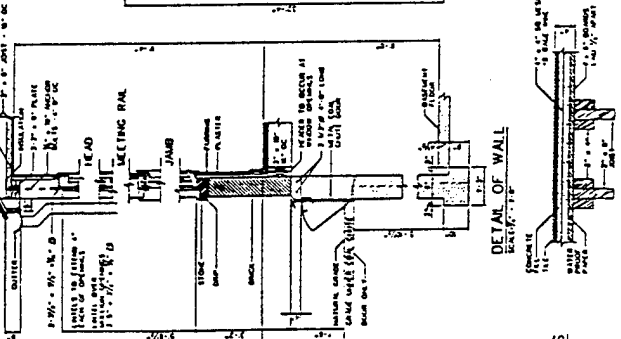

DETAIL OF TILE FLOOR IN BATHROOM
SCALE: 1/4" = 1'-0"

DETAIL OF OPENINGS
IN CONCRETE WALLS

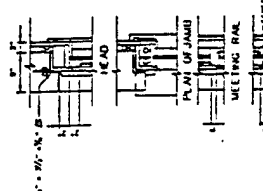

TYPICAL WINDOWS DETAILS
SCALE: 1/4" = 1'-0"

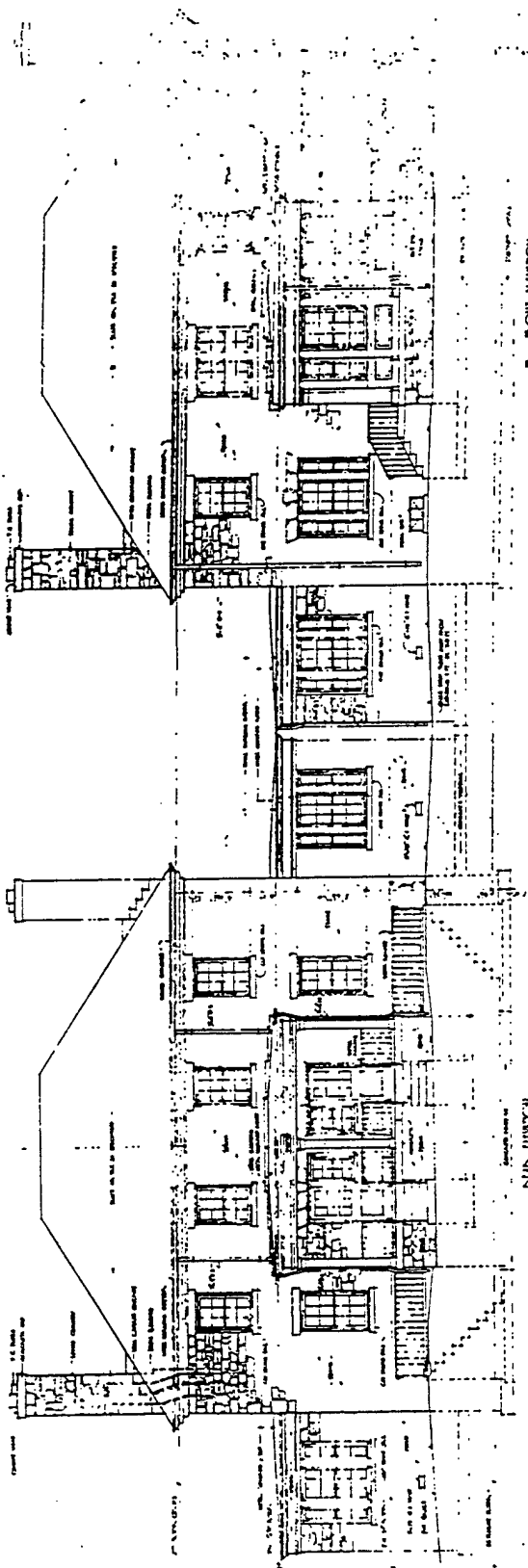

FRONT ELEVATION

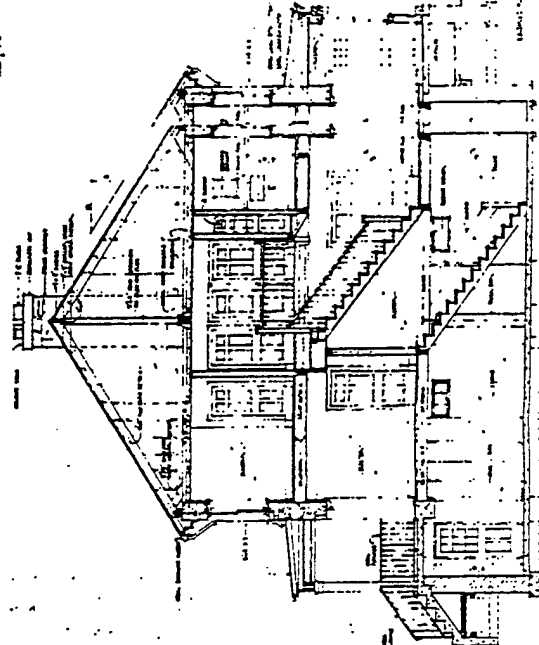

SECTION 1-1 (see location)

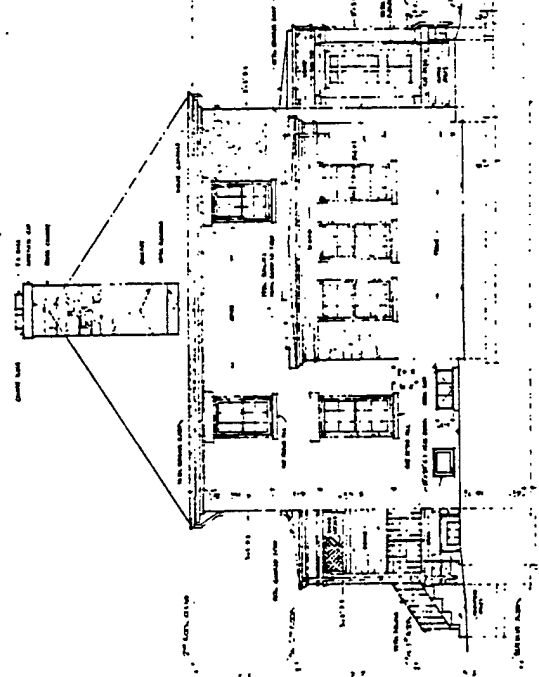

LEFT SIDE ELEVATION

375 391

FORT RILEY, KANS.
DONALD W. COOPER, ARCHT.

NO. 125, 06, C11
A. S. A.
62539723

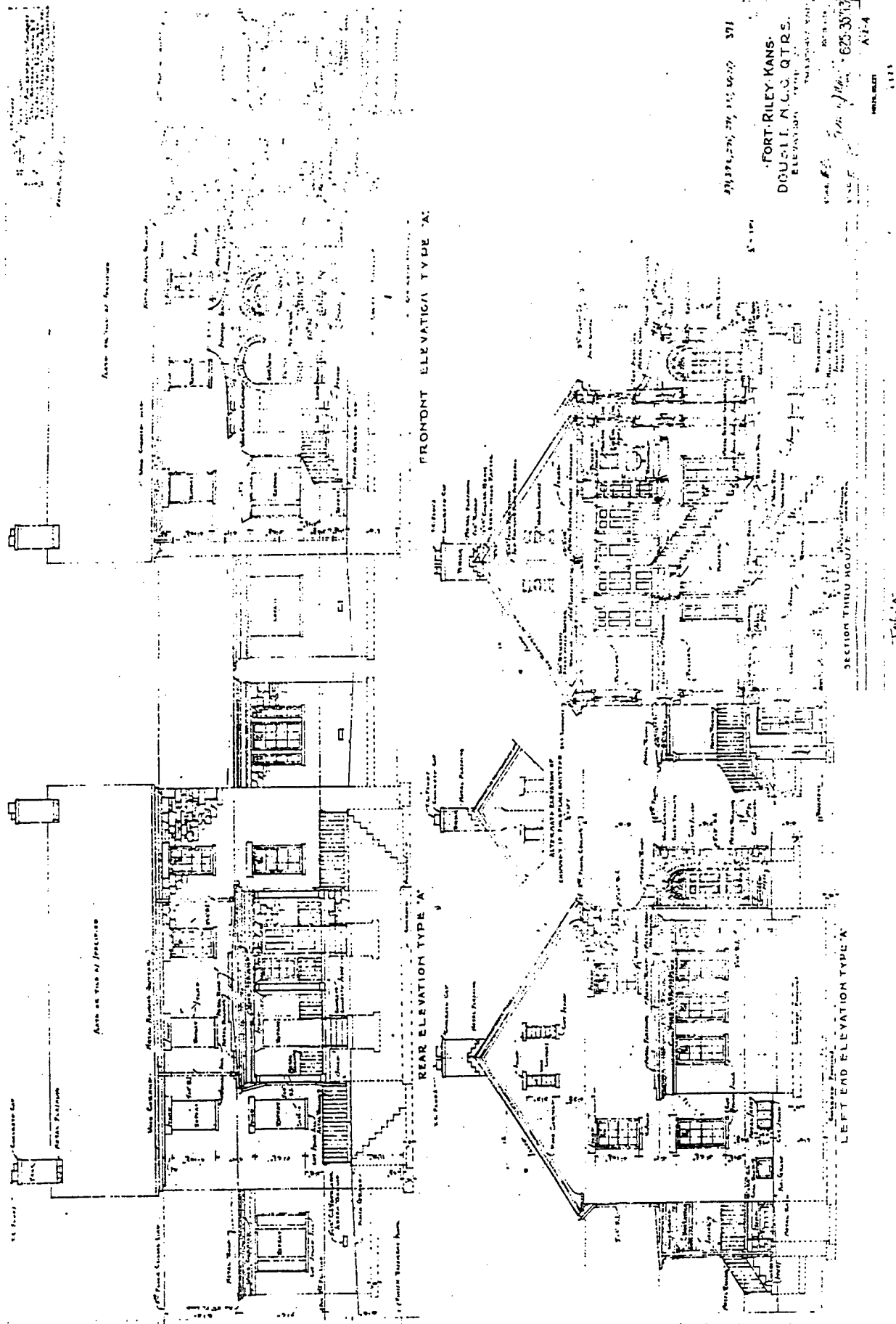

7/13/50, 2/28/51, 3/15/51, 5/27/51 371

FORT RILEY, KANS.
 QUARTERS, N.C.C. QTRS.
 ELEVATION TYPE A

SCALE: 1/8" = 1'-0"
 DATE: 7/13/50
 625-35713
 AREA 4

FRONT ELEVATION TYPE A

REAR ELEVATION TYPE A

LEFT END ELEVATION TYPE A

SECTION THRU HOUSE

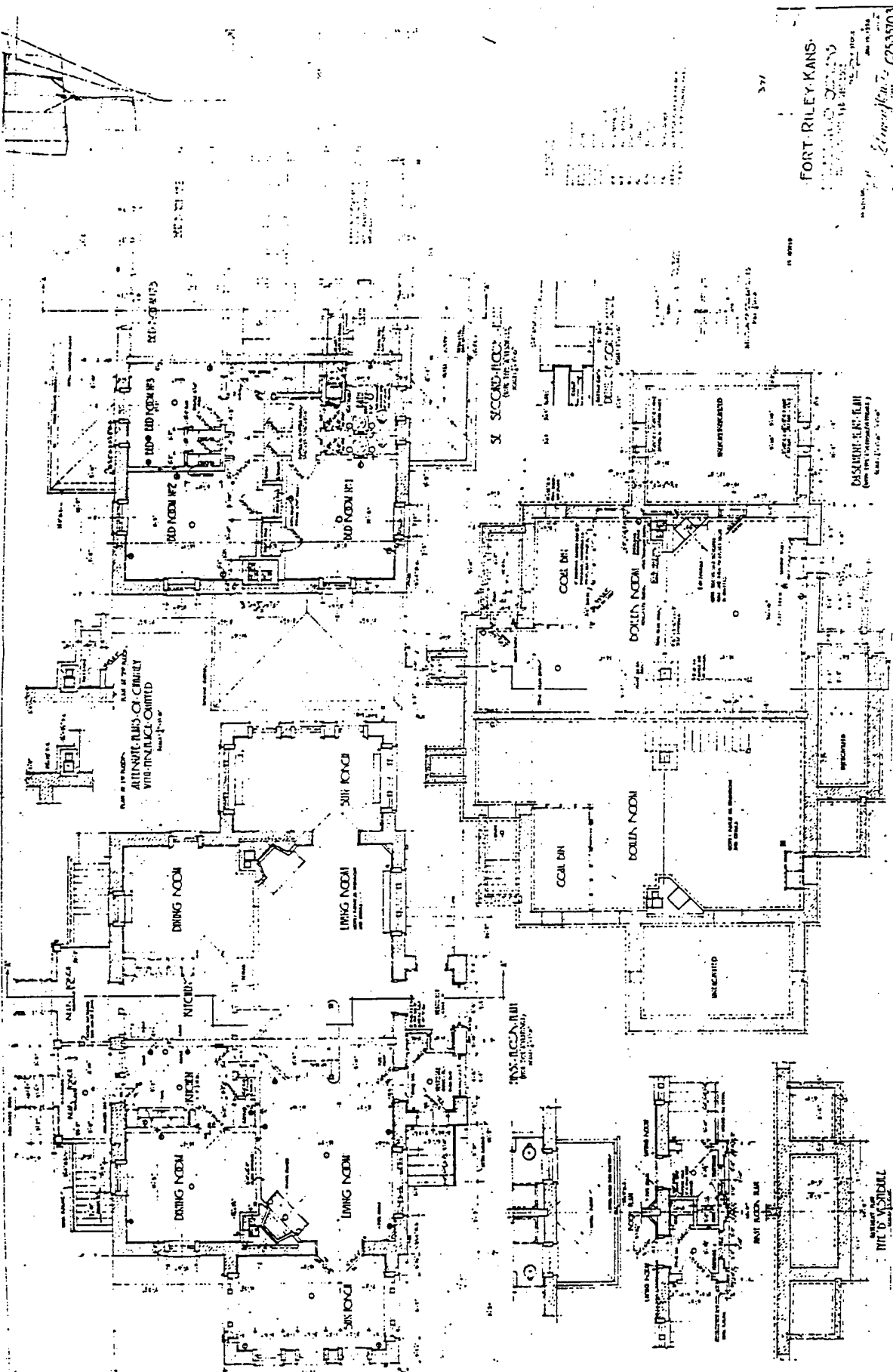

FORT RILEY, KANS.
 ARCHITECTURAL DRAWING
 No. 125-01-011
 377
 E. M. ...
 22535103

Institutional Housing - 287

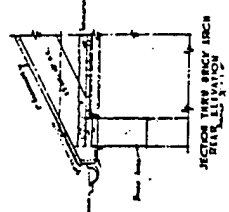
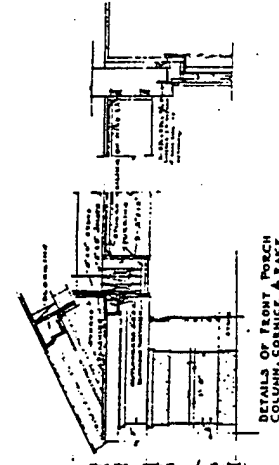
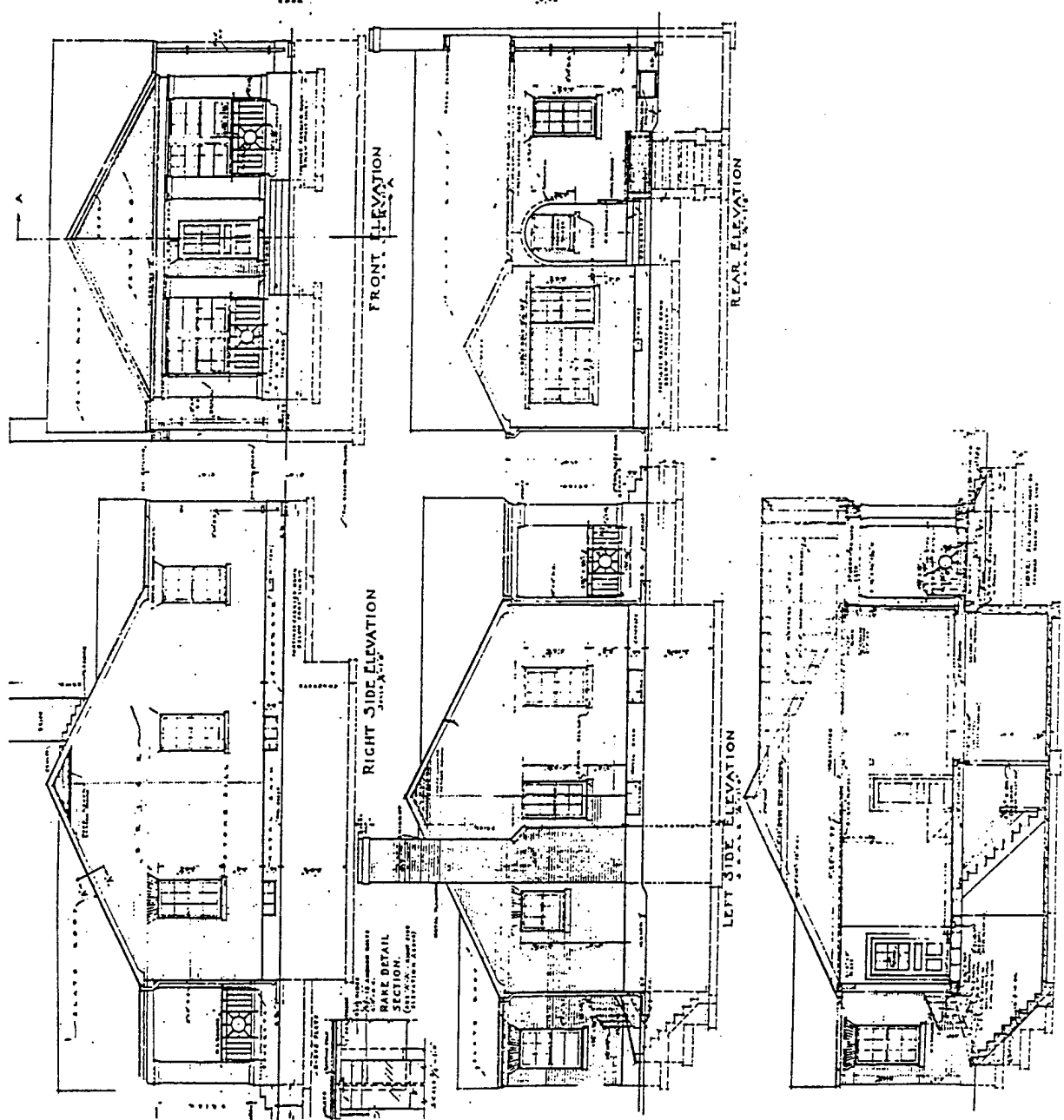

NOTE:
THIS DRAWING SUPERSEDES
DRAWING No. 625-1530

SCALE: AS NOTED A3-4

CONSTRUCTION DIVISION
OFFICE OF THE QUARTERMASTER GENERAL
36

N.C.O. QUARTERS
TYPE C-BRICK

DATE: 11/1/55
BY: [Signature]
CHECKED: [Signature]
APPROVED: [Signature]

625-1556

10798 8141

NOTES-04, C11

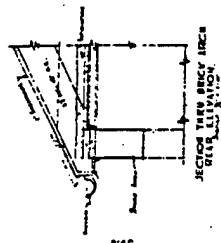
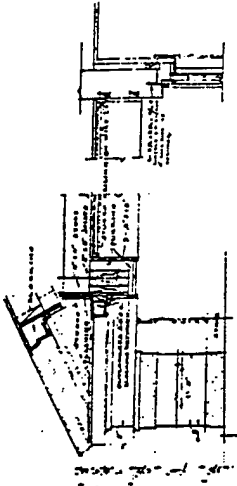
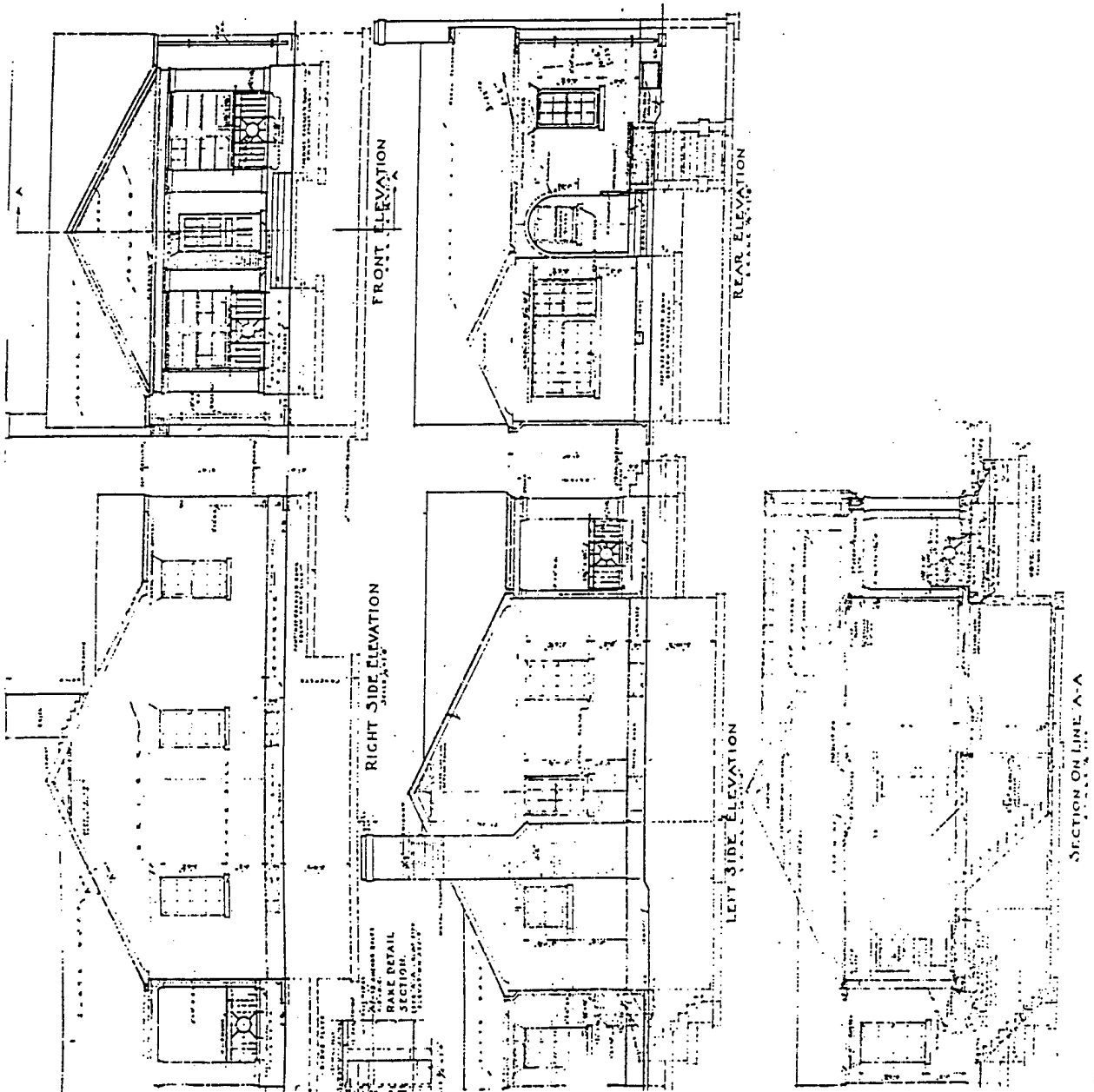

NOTE:
THIS DRAWING SUPERS EDES
DRAWING No. 625-1530

SCALE AS NOTED A-3-4

CONSTRUCTION DIVISION
OFFICE OF THE QUARTERMATER GENERAL

364-1-2-3 1-5

N. C. O. QUARTERS
TYPE-C-BRICK

625-1556
NOTES, 06-CIT

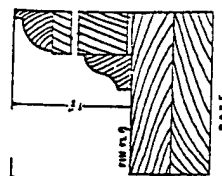
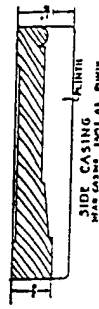
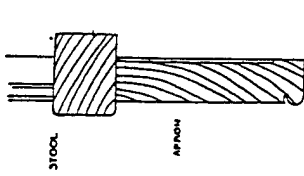
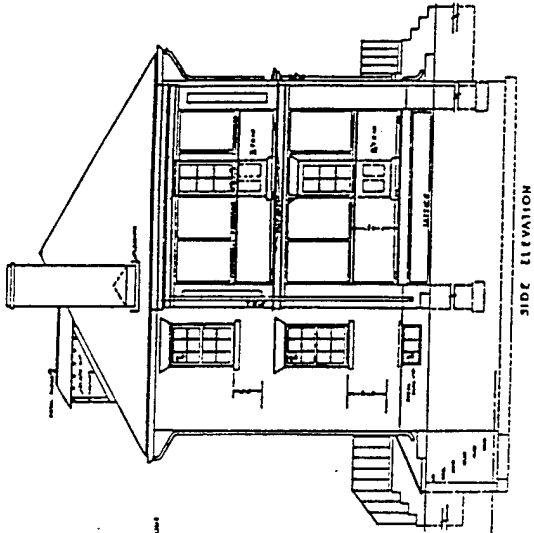
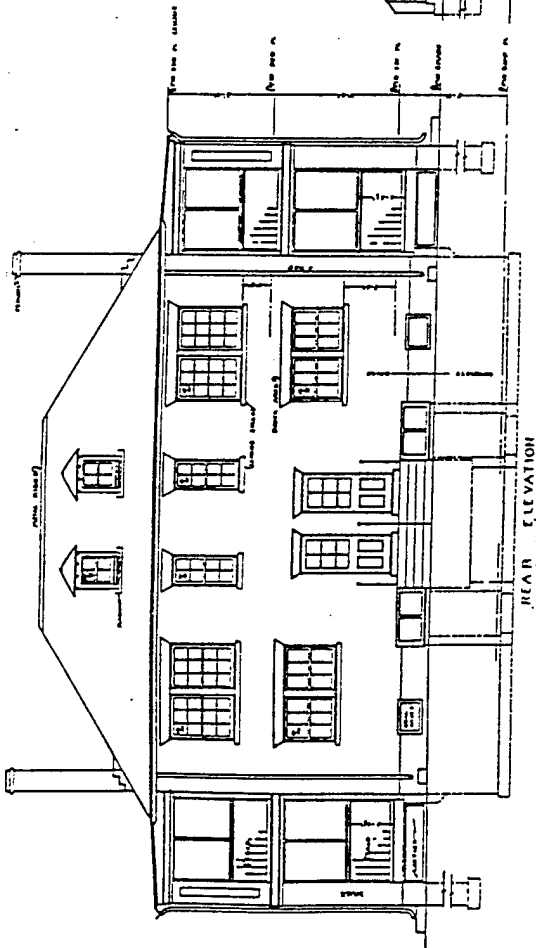

F.S. DETAILS OF INTERIOR TRIM

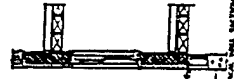
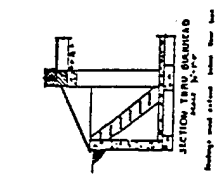
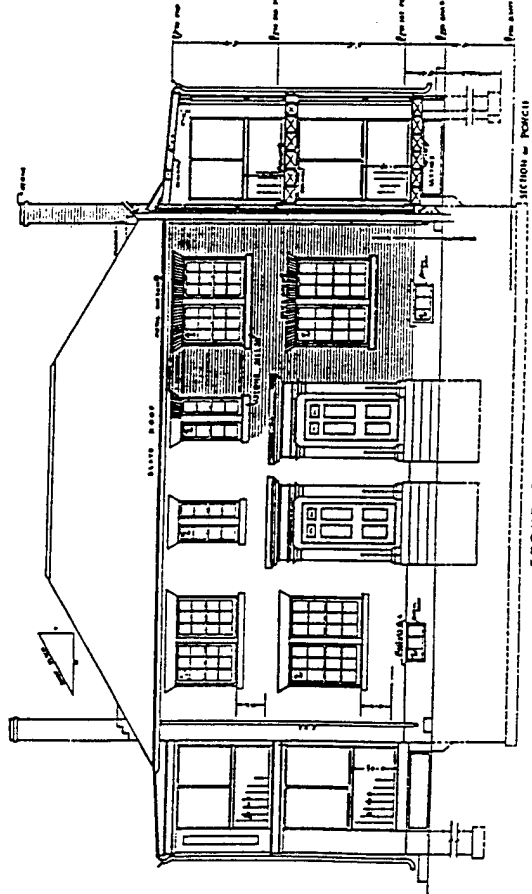
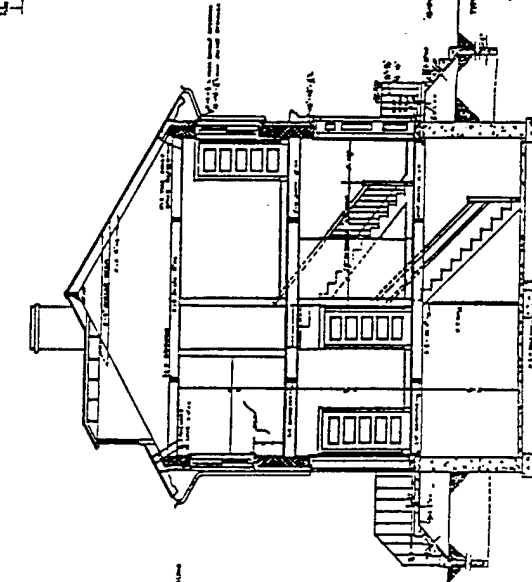

U. S. FILE A-3-3
PLAN FOR
NCO DOUBLE
QUARTERS
 G.M.O. PLAN NO. 443-541
 OFFICE OF CONSTRUCTING QUARTERMASTER
 FORT RILEY, KANSAS
 MAY 1920
 SCALE 1/8" = 1'-0"

SECTION A-A
 SHEET NO. 10-D
 ARCHITECT
 RICHARD A. BERRY
 215 WEST 12TH ST.
 OMAHA, IOWA

10415-05.G11

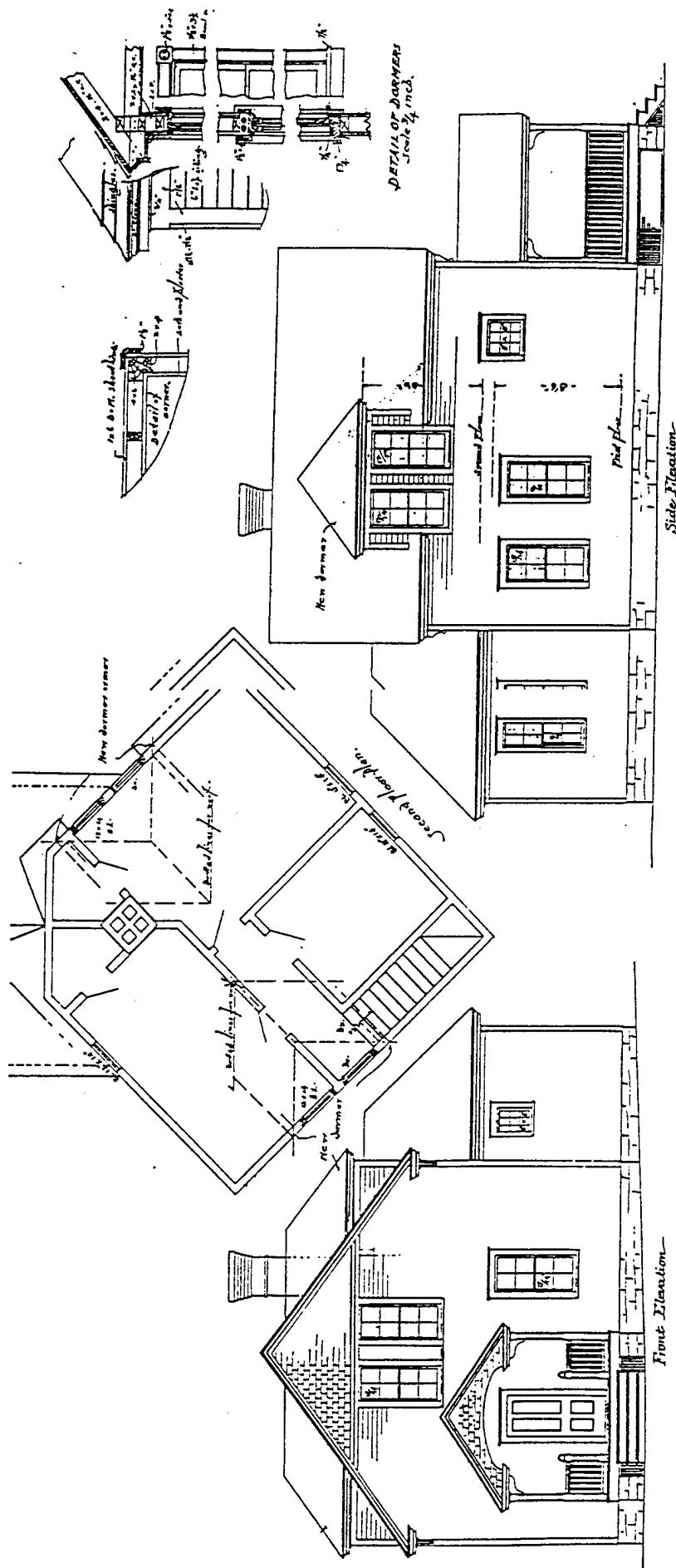

Frame Quarters for Noncommissioned Officers. Bldg. 707.

First Floor Plans.
Scale 1/4 inch.

CON. Q. M. OFF. OF THE OFFICE JUNIOR 1920. SHEET-2 U FILE A12-7

1917

10597-02.017

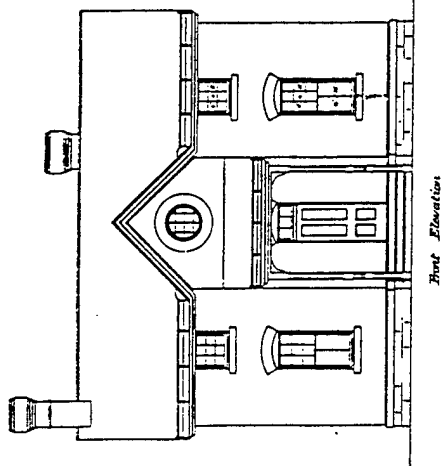

Front Elevation

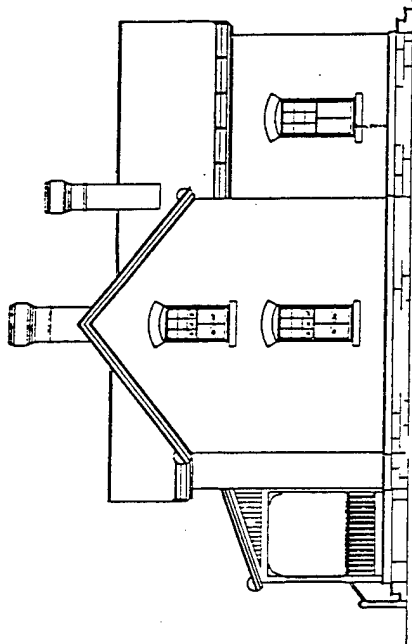

Side Elevation

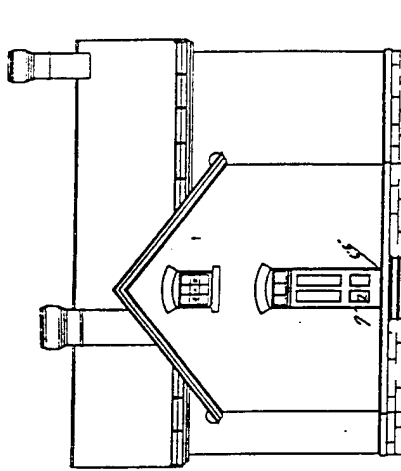

Rear Elevation

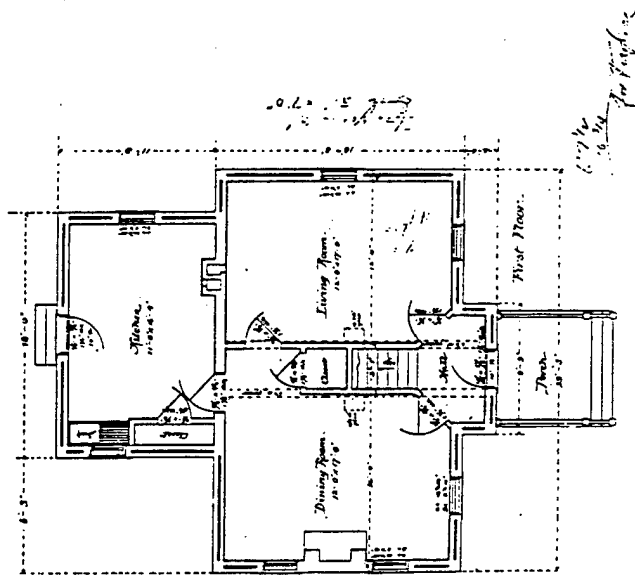

First Floor

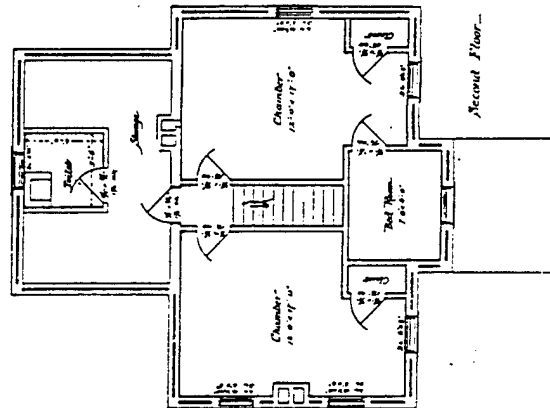

Second Floor

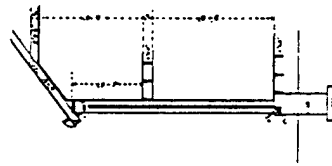

Quarters A. Second, Standing Engineer
 Rev. Wm. Jones
 1873
 Cap. Geo. W. Jones
 1873
 Arch. No. 1
 Sheet 1
 File No. 1-6

Copy for
 the Engineer

Category: RESIDENTIAL

Type 9 c-2: Family Housing: Officer Housing

Description:

The military constructed officer family quarters on the majority of its installations with residential populations. Officer housing is stratified according to rank. Each installation generally had one house for the commanding officer and additional housing for other officers. Officers quarters were a prominent component of military installations and usually were major buildings on installations. Their architectural character reflected their period of construction and the anticipated permanence and importance of the installation. Simple houses were built at frontier posts, while departmental headquarters or shipyards often received larger, more ornate senior officer housing. The evolution of officer housing illustrates the military's adaptation of contemporary architectural trends in the military's construction program.

Evolution:

The Army began to construct family housing for officers at its permanent installations during the early nineteenth century. The earliest officers quarters were built at permanent installations such as coastal fortifications, armament factories, education facilities, and permanent western posts. The small size of the garrisons posted to these early installations necessitated few quarters. The earliest quarters display diversity in size and architectural detailing, depending on available funding and the rank of the resident. Installations generally included a single-family dwelling for the commanding officer and multiple-family dwellings for junior officers.

The Army began to develop standardized plans for many basic property types, including officers housing. In 1860, unofficial regulations for Army construction were drafted that included plans for officer housing. The 1860 regulations, though never officially adopted, seem to have recorded existing Army construction and housing practices. The assignment of quarters according to rank is clearly established. The 1860 proposed regulations prescribed single quarters for field officers and captains, and duplex housing for junior officers. The plans depict houses with simple features that could be constructed from a variety of local materials. The 1860 proposed regulations also contained a prototypical post plan, which depicted officer housing along the side of the parade ground facing the barracks.¹⁸ During the nineteenth century, this was the typical location of officer housing.

In contrast with the concurrent effort at standardization, special branches within the Army were responsible for the construction of their installations and did not employ the Quartermaster Department or Quartermaster plans. For example, officers of the Ordnance Department were responsible for the construction of arsenals. Due to higher levels of funding and lack of standardization, Ordnance Department installations sometimes displayed grander and more

¹⁸ War Department, *Regulations Concerning Barracks and Quarters for the Army of the United States, 1860*, 1-2, 7.

varied design than commonly was found at other Army posts. Thomas Rodman designed Watertown Arsenal, Massachusetts, and Rock Island Arsenal, Illinois. The imposing, stone, Italianate commanding officers residence at Rock Island, completed in 1871, has over fifty rooms and is the largest family quarters owned by the Army.¹⁹

In 1872, the Quartermaster General, Montgomery C. Meigs, proposed standardized plans for post construction, including officer housing. Meigs hoped to control costs and to establish consistent construction standards at the expanding number of Army posts. Western frontier posts were particularly notorious for their poor living conditions. The plans for officers quarters in the 1872 proposed plans are larger and show more attention to architectural detailing than the 1860 plans.²⁰ Quarters were constructed at many western posts, sometimes as depicted in the plans, as at Ft. Sill, Oklahoma, and sometimes with local variations on the exterior, as with the Gothic Revival version of the standard plan built at Ft. Douglas, Utah.

During the 1880s and 1890s, the Army began to close the numerous small, scattered, temporary western posts and to consolidate its troops into larger, permanent posts. The Army initiated major building projects for new facilities and for expansion of older posts that were retained. The Quartermaster Department made a concerted effort to construct buildings of greater architectural stature that projected an increased awareness of the prestige of the military. In some cases, professional architects were employed to design installations. These architects designed larger, more elegant officer housing in contemporary, nationally popular architectural styles, including Italianate, Romanesque Revival, and Queen Anne.

During the late 1890s, the Army began another effort to standardize officer housing for better cost control. Beginning in the late 1890s and continuing through the first decade of the twentieth century, the Army constructed the same officer housing, designs on most Army posts with very little individual modification. Colonial Revival architecture dominated Army construction of this era. Like their civilian contemporaries, the early examples of Colonial Revival architecture at Army posts are not historically accurate re-creations of early American architecture, but interpretations that mix colonial precedents with some elements of the Queen Anne and other eclectic styles. Character-defining features of Army housing of this era include cornices with dentil molding, pediments, columns, and jack arches over windows. In the west and southwest, the Quartermaster Department experimented with Spanish Colonial and Mission architectural styles.²¹

The Army also issued regulations in the early twentieth century to standardize the assignment of quarters. These regulations helped to limit the circumstances under which a senior officer could displace a junior officer from his quarters. The regulations directed the post quartermaster to assign quarters to each officer according to his rank. At posts with insufficient housing, the

¹⁹ Thomas J. Slattery, *An Illustrated History of the Rock Island Arsenal and Arsenal Island, Part Two*, Rock Island, Illinois, Historical Office, U.S. Army Armament, Munitions and Chemical Command, 1990, 44.

²⁰ War Department, *Annual Reports of the Quartermaster-General, 1872*, plates 4-7.

²¹ NARA, Cartographic Branch, RG 77, Standard Plans of Army Post Buildings, 1891 - 1918, Plan 235.

commander could apply to the Secretary of War for the authority to lease the necessary quarters.²²

During the 1920s, the Army suffered from a nationwide housing shortage. The Quartermaster Corps constructed few officer family quarters, and those constructed were criticized severely. For example, the quarters constructed at Ft. Benning were considered unsuitable for the hot Georgia summers.²³ After a Congressional investigation into living conditions on Army posts, the U.S. Congress enacted Public Law 45 in 1926, which allowed the Secretary of War to build new installations from money obtained by selling unneeded posts. Upon passage of this law, the Army embarked on a massive building program. In 1933, the government further expanded the construction program through the appropriations of Depression-era public works funds for additional construction at military installations.

The installations constructed and expanded during the 1930s were much larger than previous installations, and thus were organized differently. The buildings were no longer arranged around a central parade ground. Officer housing, instead of lining one side of the parade ground, was arranged in areas that one planner referred to as "executive living area[s]" arranged in neighborhoods around curving streets and parks.²⁴

The Construction Service of the Quartermaster Corps developed standardized plans for this new wave of construction that were designed to respond to the local climate and to reflect local architectural history. The architects also devoted attention to designing comfortable, modern houses. Georgian Colonial Revival was used for installations located from New England to Virginia, in the Midwest, and in the Pacific Northwest. Spanish Colonial Revival housing was built in the South, Western Plains, Southwest, and California. Other regional designs included French Provincial in the Gulf States and a few examples of English Tudor Revival.²⁵

Officer housing, though standardized, displayed a variety of types. Two-story quarters were the most common, but the Construction Service also designed one-story bungalow designs. Duplex housing, which had been the common type for company officers prior to the First World War and had even been used by Quartermaster General Meigs in 1872, was replaced by more single-family housing. The Army also began constructing more small apartment buildings, similar to garden apartment units. During the early 1900s, the Quartermaster Department had started to build apartments, usually four-family buildings, at consolidated, permanent posts. The quartermaster proposed that apartments would appeal to officer wives because an apartment would not require maid service or major individual cooking facilities. However, the apartments were not a success. Army wives claimed to prefer single-family dwellings. During the 1930s

²² War Department, General Staff, *Manual for the Quartermaster's Department*, United States Army, 1904, Washington, D.C., Government Printing Office, 1904, 102-104.

²³ Robinson Fisher Associates, Inc., *Historic Building Survey: Fort Benning, Georgia*, MSS, Ft. Benning, 1987, 16-17, 23.

²⁴ Hallauer, "Landscaping the Army Post," 28-31.

²⁵ Lt. Col. Francis B. Wheaton, "The Architecture of the Army Post", *The Quartermaster Review*, (September-October 1928):10-13.

construction era, the Quartermaster again constructed four-family apartment buildings for student officers at training and educational installations.²⁶

The new housing program officially came to an end on June 15, 1940, when the War Department halted all family quarters construction in preparation for the wartime mobilization.²⁷ Despite these orders, limited family housing construction was completed in the second half of 1940, notably at several Army Air Corps depots, where streamlined, Art Moderne designs were introduced. These last designs before the start of World War II presaged the more minimalist designs favored during the post-war years.

Association:

Officers quarters are associated with the evolution of living standards for military personnel. Officer housing construction directly reflects the history and status of the military during the period of construction. The design of officer housing was influenced by civilian architecture and the military's self-perception of its role and prestige. Officer housing typically is a major element in the installation plan and occupies a location that illustrates the hierarchical arrangement of life on military installations. Officer housing usually is a contributing element in an installation historic district, or can itself constitute an historic district. Individual officer quarters may possess individual significance if it embodies the distinctive characteristics of a type or period of construction, represents the work of a master builder or architect, or possesses high artistic values. In addition, officer housing may be associated with the military careers of important individuals.

Integrity:

To possess integrity, officer housing should retain its location and most of its design, setting, materials, workmanship, and association from the property's period of significance. Most officers' quarters have been used as dwellings throughout their history, though the buildings often have undergone modifications to meet modern living standards. Typically modified exterior features include porches, windows, and roof and siding materials. In cases of subsequent additions or alterations, the quarters still may have integrity if it retains its setting, overall design, the majority of its materials, and the majority of its architectural features that convey the property's association with the period of significance.

²⁶ J.M. Carson, "Now -- the Army Apartment," *The Quartermaster Review*, July-August 1921, 71-73, 81.

²⁷ Grashof, *A Study of United States Army Family Housing Standardized Plans, 1866 - 1940*, Vol., 1, 56.

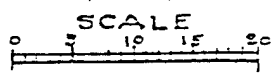
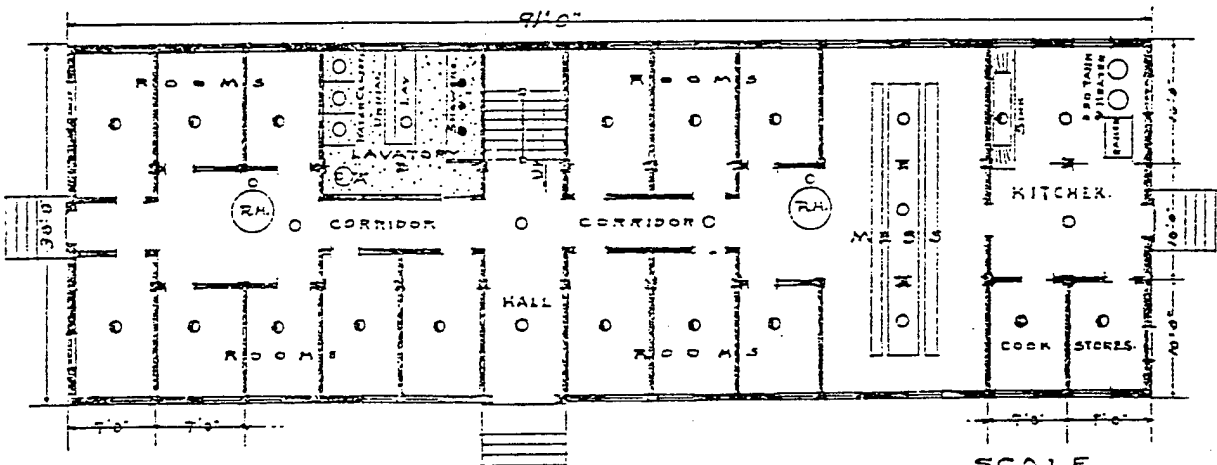
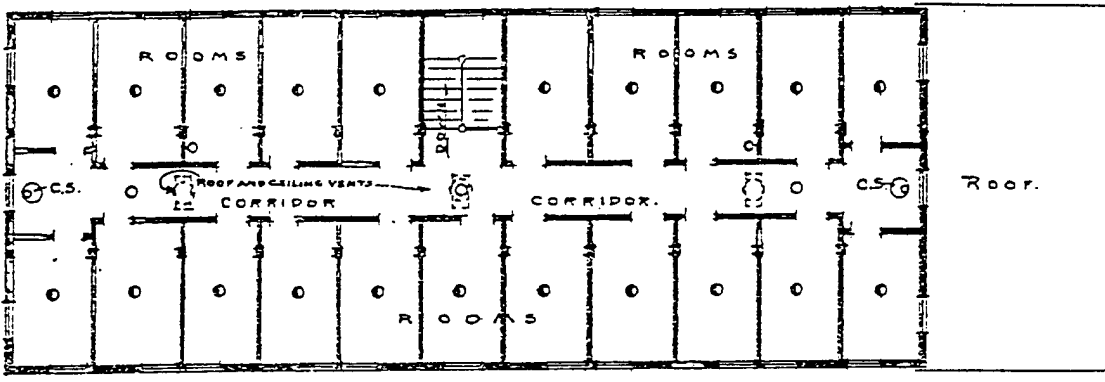
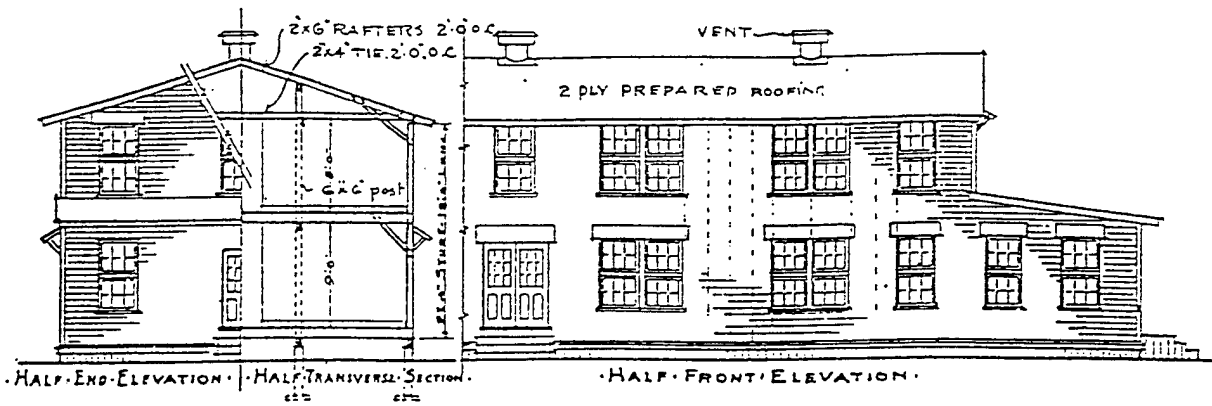

IF STOVES ARE OMITTED, CONTINUE CORRIDORS 4' WIDE THROUGHOUT. ROOMS ARE FOR ONE OFFICER EACH.

FOR GEN'L DRAWINGS - 620-354
 FOR DETAILS - 620-314, 325, 329, 330, 420 & 463
 FOR WIRING - 620-367

NUMBER OF OFFICERS	TOTAL LENGTH OF BUILDING	LAVATORY			ROOM HEATER 2 REQUIRED.			CANNON STOVE 'A'			CANNON STOVE 'B'			FLUE SIZES	MAN RANGE.
		W.	C.S.	SHOWERS	X	Y	Z	X	Y	Z	X	Y	Z		
19	63'	2	2	6'-0"	6'-0"	HR	HR	HR	7C	7C	9C	12C	12C	12C	20
23	70'	2	2	6'-0"	6'-0"	HR	HR	HR	7C	7C	9C	12C	12C	12C	20
27	77'	3	3	8'-0"	8'-0"	12R	14R	14R	7C	7C	9C	12C	12C	12C	40
31	84'	3	3	8'-0"	8'-0"	12R	14R	14R	7C	7C	9C	12C	12C	12C	40
35	91'	3	3	8'-0"	8'-0"	12R	14R	14R	7C	7C	9C	12C	12C	12C	40
39	98'	3	3	8'-0"	8'-0"	12R	14R	14R	7C	7C	9C	12C	12C	12C	40

CONSTRUCTION DIVISION OF THE ARMY
 TYPICAL BUILDINGS
 TWO STORY OFFICER'S QUARTERS
 WITH LAVATORY AND MESS.

SB-5



QUARTERS
for
COMMANDING OFFICER
Artillery Regt, Fort Riley, Kan.
Designed by
CAPT. GEO. R. POND, A.Q.M., U.S.A.

Front Elevation
Scale 1/4" = 1'

h0 100_01.cit
HW100_01.CIT 100

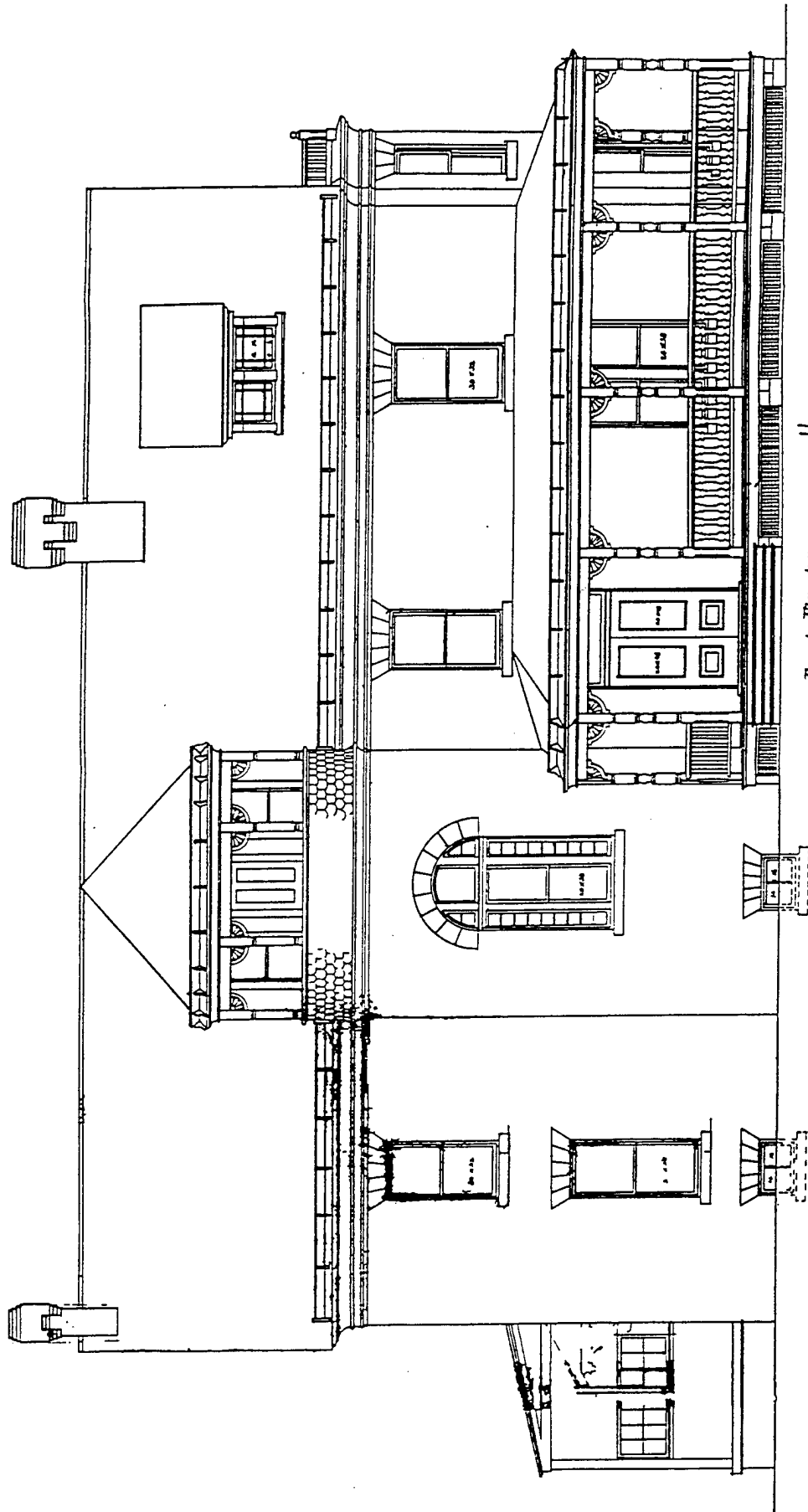

Front Elevation
Scale 1/4" = 1'-0"

QUARTERS FOR COMD'G OFFICER
 Post Riley Xmas
 DESIGNED BY CAPT CARL E. FOND,
 A. Q. M., U. S. A.

#1

110001.01 CITY

HO-001-01-CIT

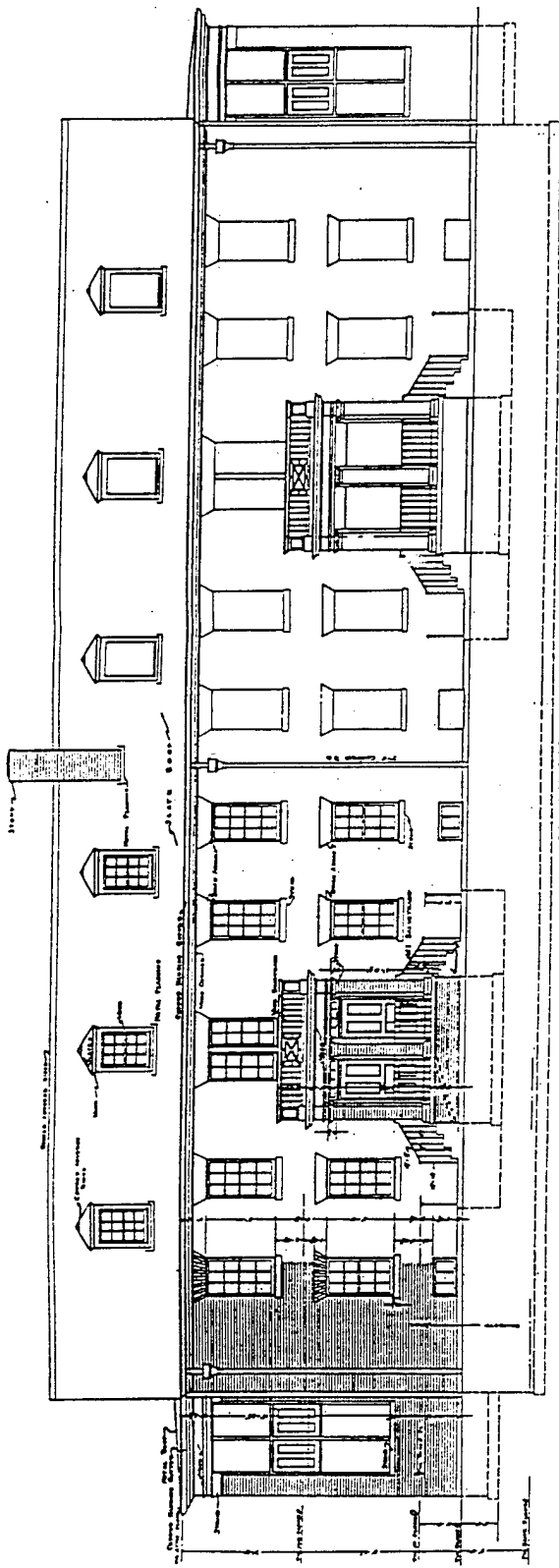

FRONT ELEVATION

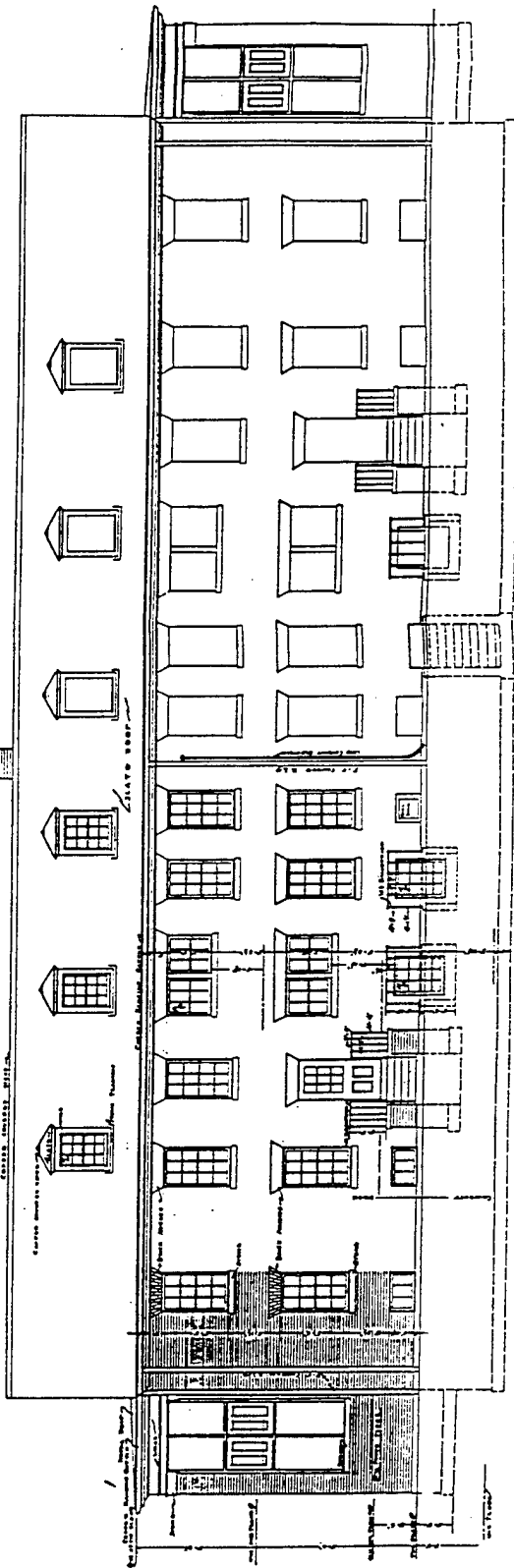

REAR ELEVATION

Plans for
 FOUR FAMILY APARTMENT HOUSE
 FOR COMPANY OFFICES
 AND WITH NEARBY
 OFFICE OF THE CONSTRUCTION COMMISSIONERS
 1000 ...
 1915

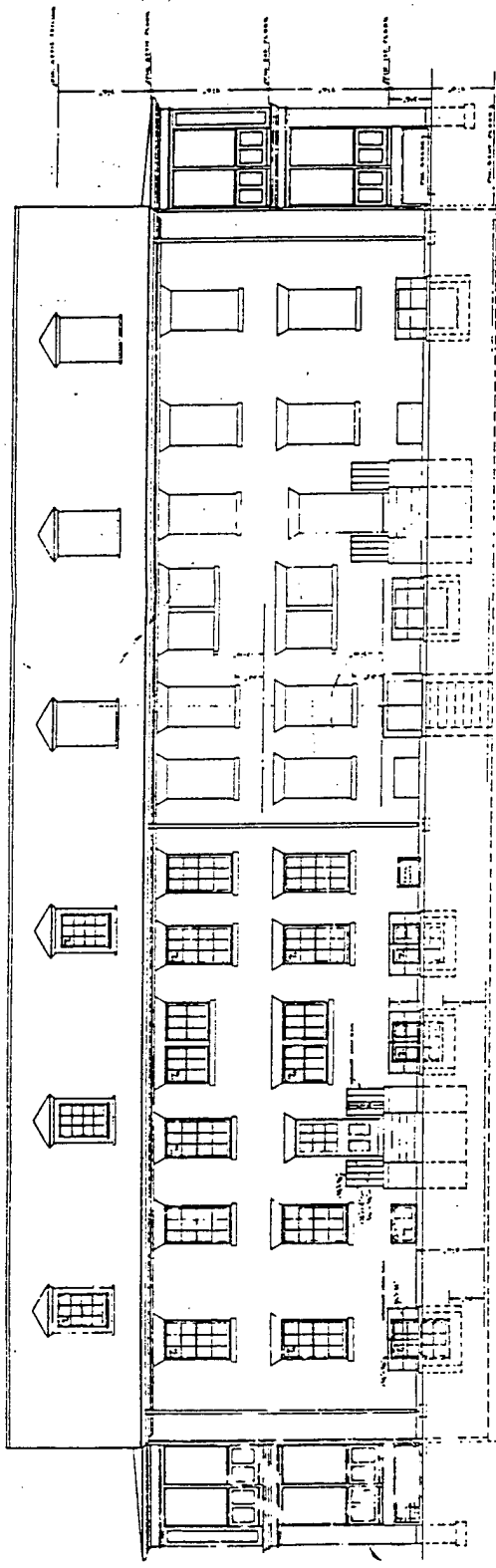

REAR ELEVATION
SCALE: 1/4" = 1'-0"

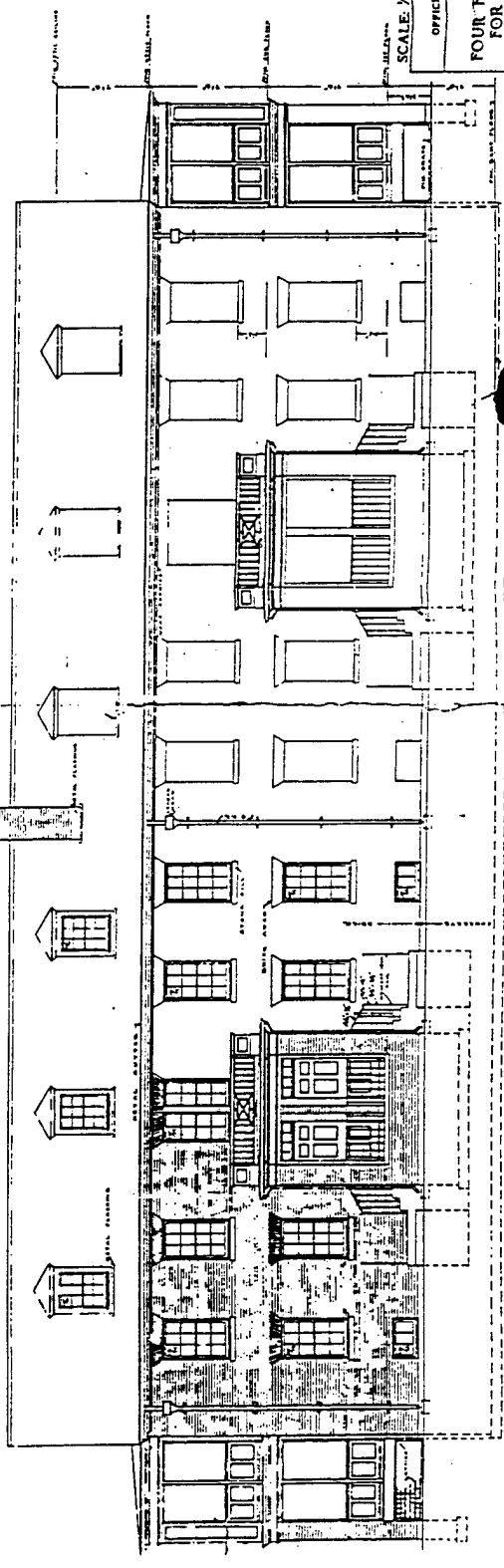

FRONT ELEVATION
SCALE: 1/4" = 1'-0"

CONSTRUCTION SERVICE
OFFICE OF THE QUARTERMASTER GENERAL
FT. RILEY KANS.
FOUR FAMILY APARTMENT HOUSE
FOR COMPANY OFFICERS

SCALE: 1/4" = 1'-0"
DATE: 1918
DRAWN BY: [Signature]
CHECKED BY: [Signature]
NO. 675-003

no 940.02.cjt

SCALE 1/4" = 1'-0" A-3-2

CONSTRUCTION DIVISION OFFICE OF THE QUARTERMASTER GENERAL	
MARSHALL FIELD, KAN.	
COMPANY OFFICERS QUARTERS	
DATE: AUG. 19, 1934	NO. 625-2491

This Doc. Supersedes Doc. No. 623-1487
NOTE - All work required 1/2" thick unless otherwise noted. All openings to be checked below floor level.

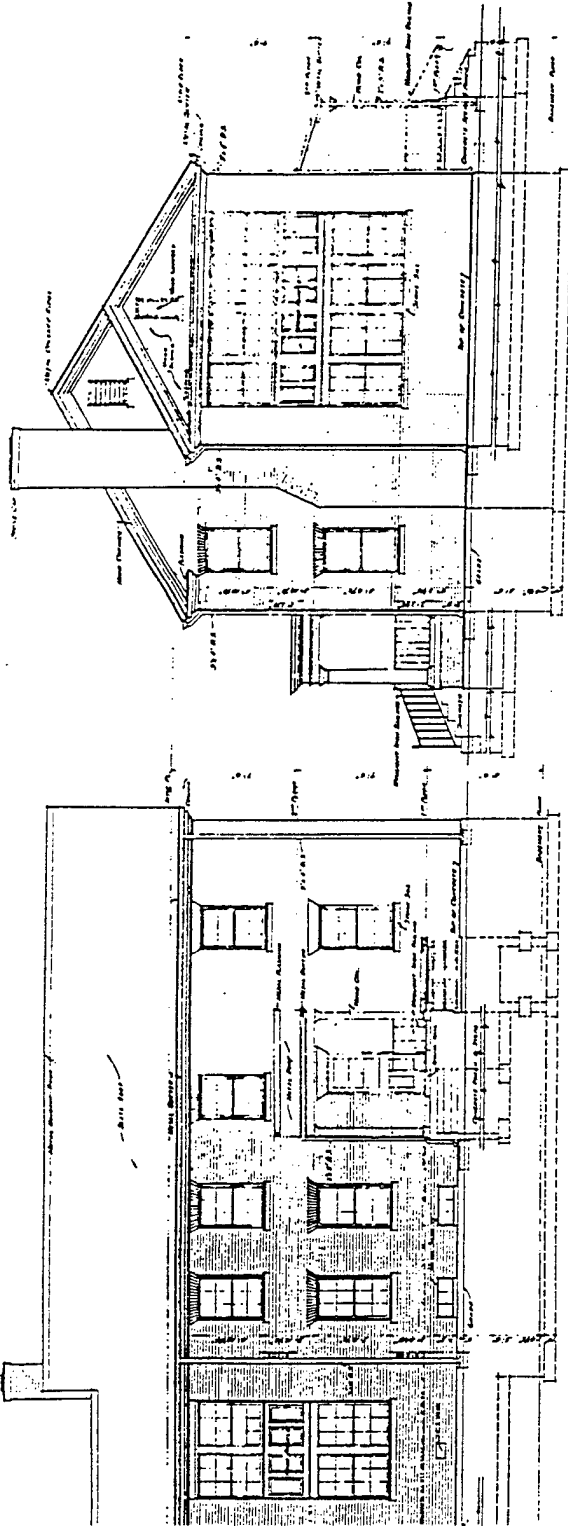

REAR ELEVATION
Sheet B-1

SIDE ELEVATION
Sheet B-2

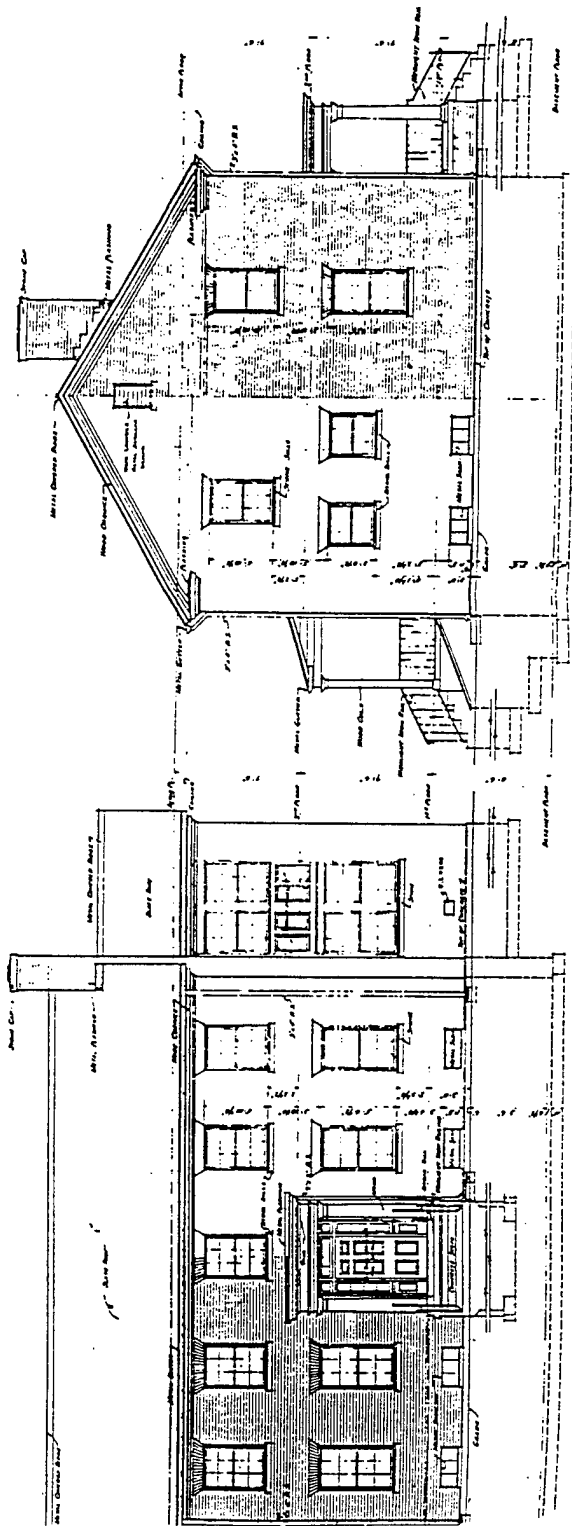

FRONT ELEVATION
Sheet B-3

SIDE ELEVATION
Sheet B-4

SCALE 1/4" = 1'-0" A-3-2

CONSTRUCTION DIVISION
OFFICE OF THE QUARTERMASTER GENERAL

MARSHALL FIELD, KAN.
COMPANY OFFICERS QUARTERS

DATE	BY	APPROVED BY	DATE
AUG. 11 1934			
PROJECT NO.			625-2491

HO786.II.CIT
28 3 28 2 28 2 28 2 28 2

HO780.II.CIT

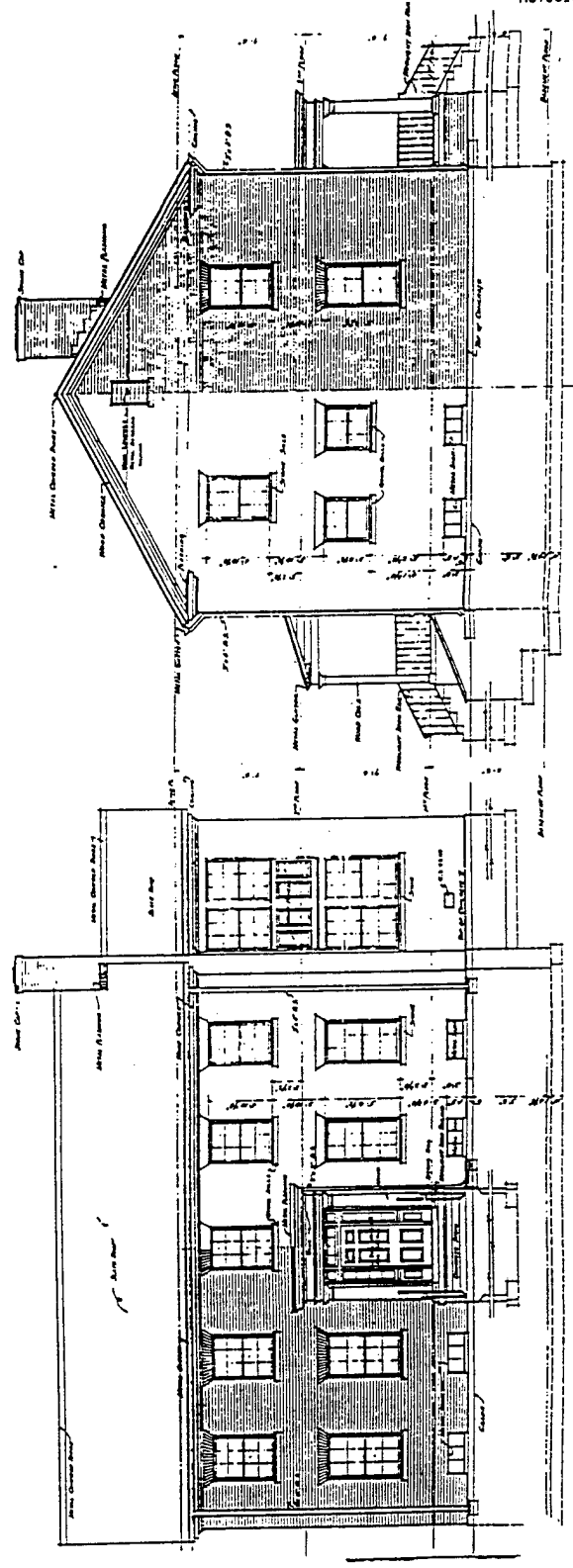
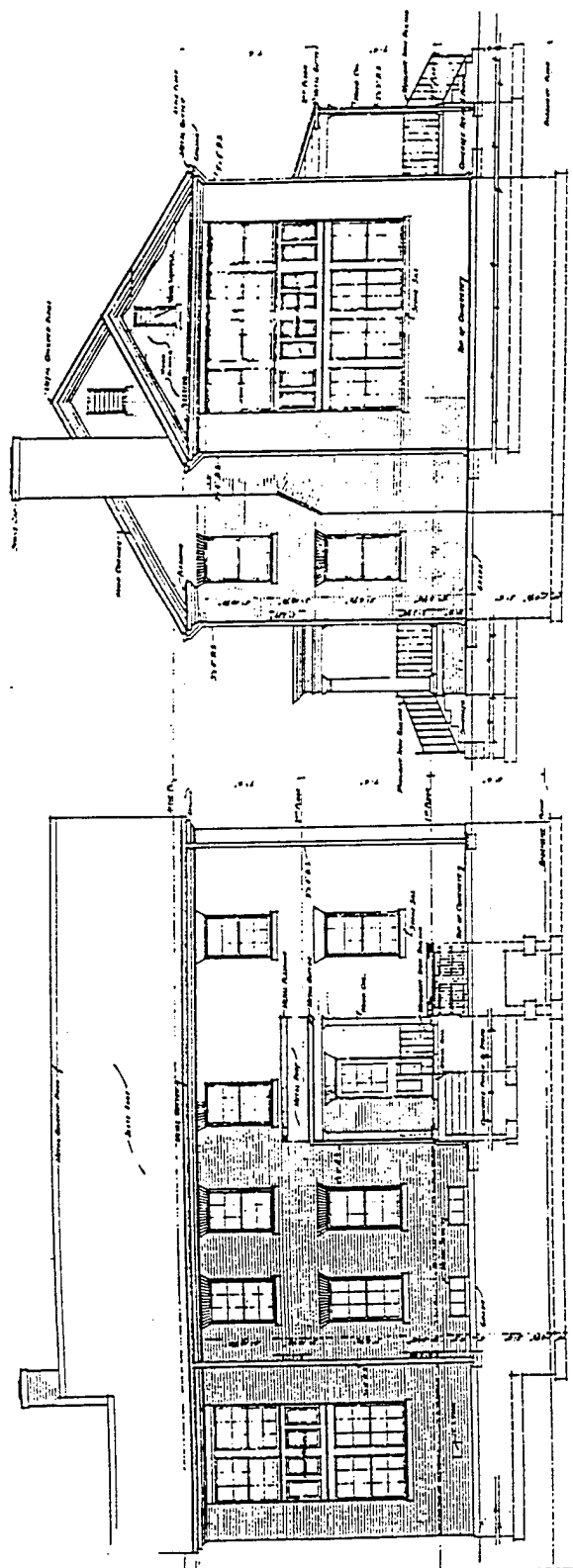

SCALE 1/4"=1'-0" A-3-3
 CONSTRUCTION DIVISION
 OFFICE OF THE QUARTERMASTER GENERAL
 MARSHALL FIELD, ILL.
 FIELD OFFICERS' QUARTERS
 35 1/2 1884
 DRAWN BY J.L.I. CHECKED BY J.K.L. DATE 10/20/08
 h0784.10.cit

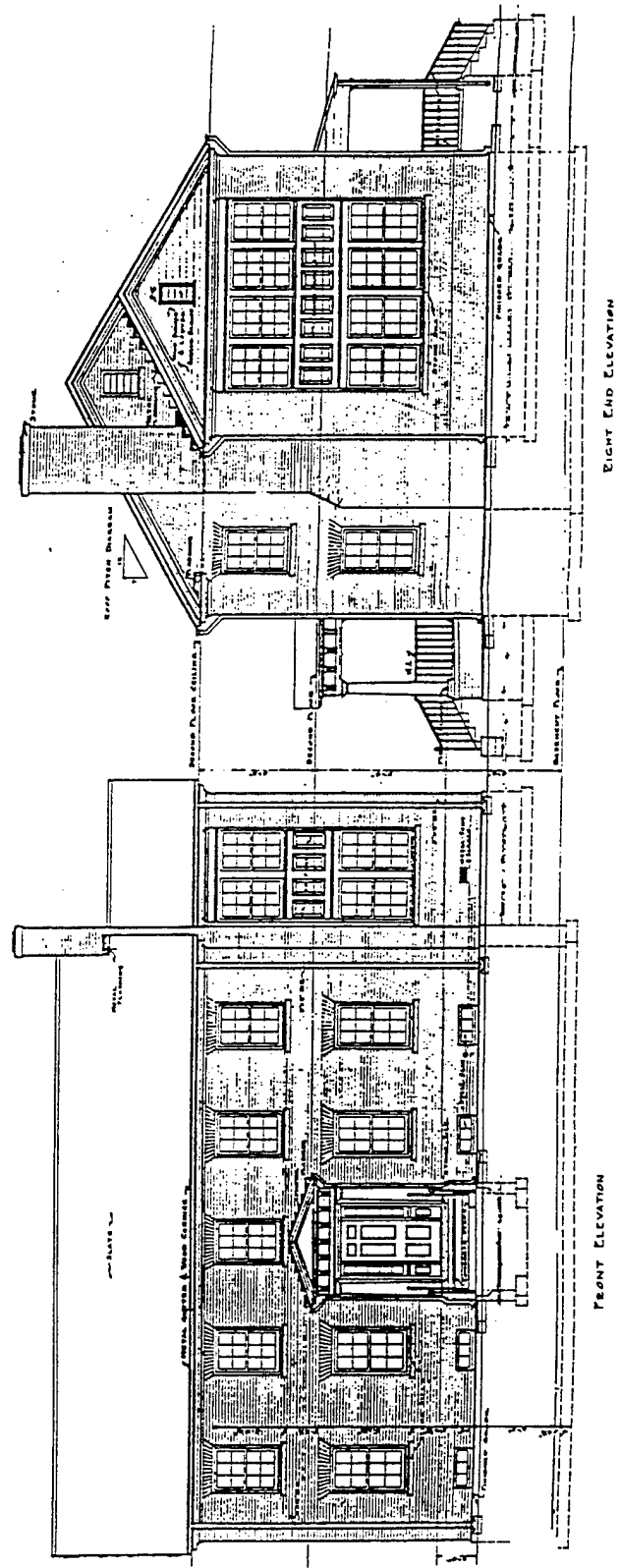
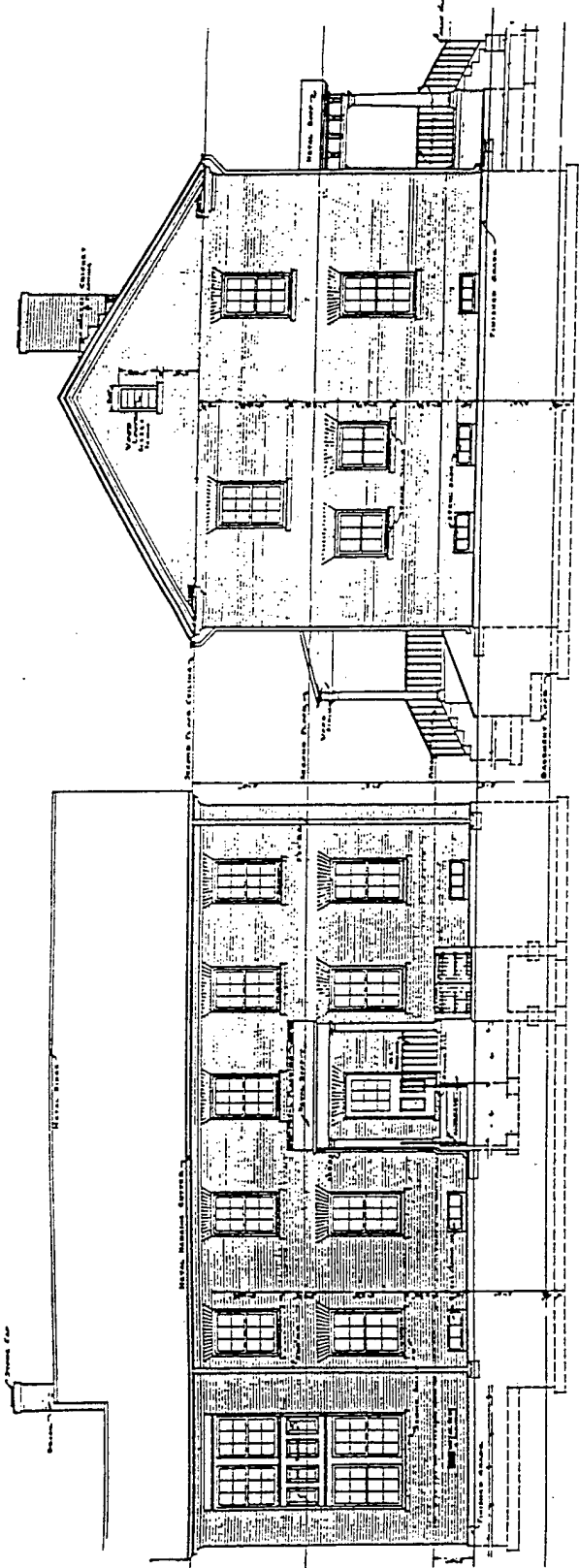

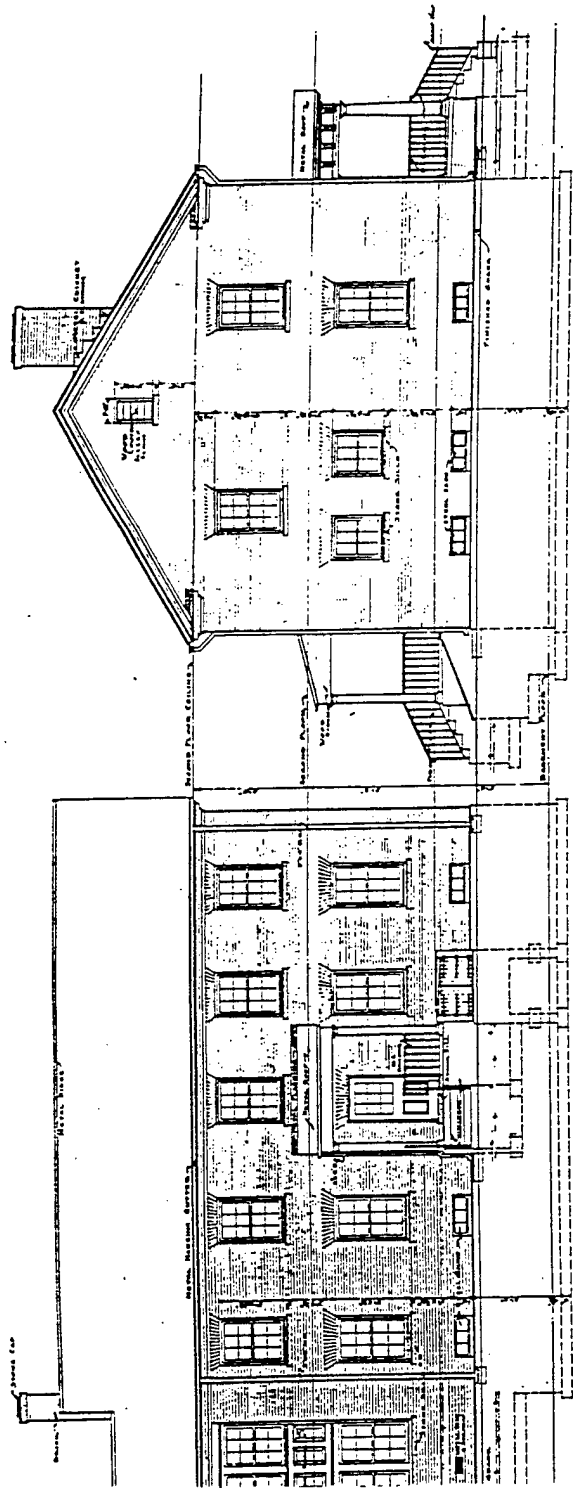

LEFT END ELEVATION

REAR ELEVATION

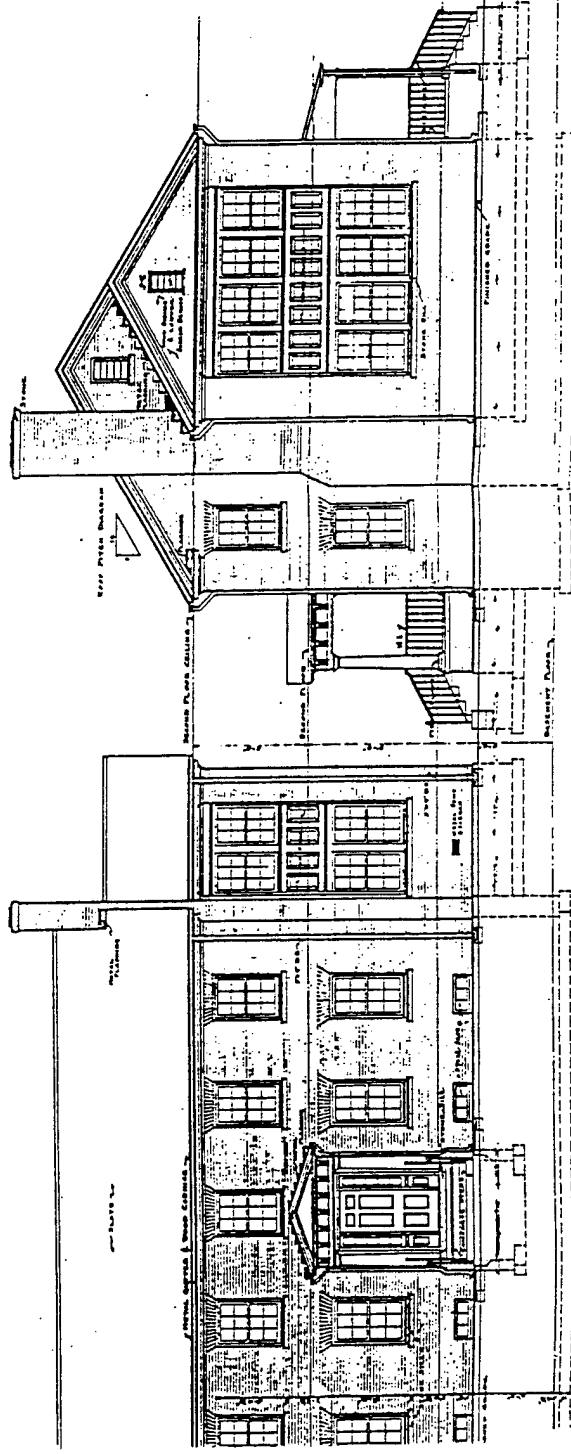

RIGHT END ELEVATION

FRONT ELEVATION

ALL WORK SHOWN IS TO BE CONSIDERED AS APPROVED UNLESS OTHERWISE SPECIFIED
 FOR THE ARCHITECT'S OFFICE - SEE THE CONTRACT

SCALE: 1/4" = 1'-0" A-3-3
 CONSTRUCTION DIVISION
 OFFICE OF THE QUARTERMASTER GENERAL
 MARSHALL FIELD, ILL.
 FIELD OFFICERS' QUARTERS
 35' 11"
 625-1341
 10784-02.GIT

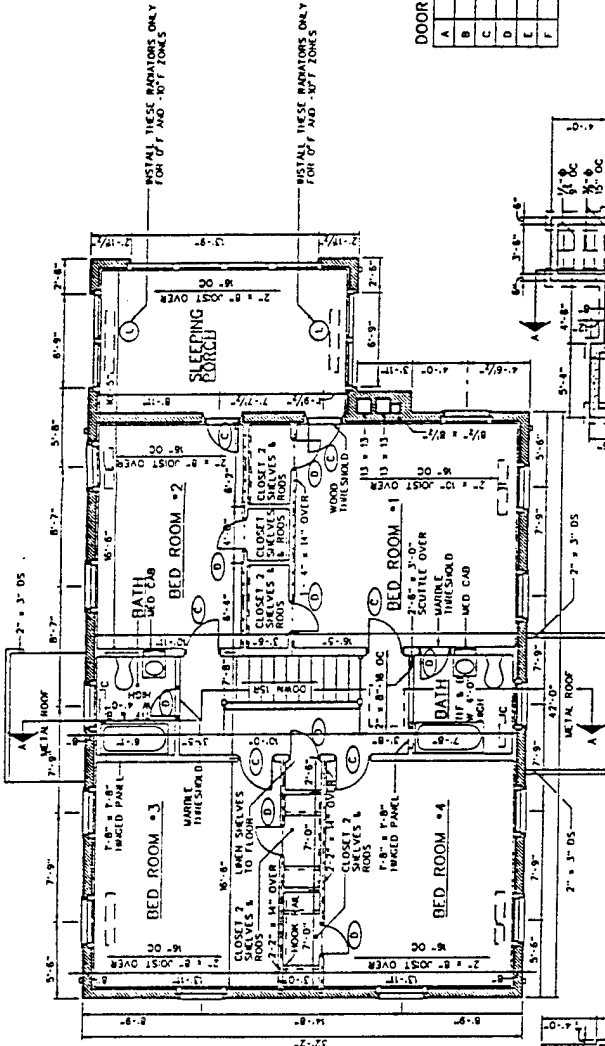

SECOND FLOOR PLAN
SCALE 1/4" = 1'-0"

DOOR SCHEDULE

A	3'-0" x 8'-0"
B	3'-0" x 8'-0"
C	2'-0" x 8'-0"
D	2'-0" x 8'-0"
E	2'-0" x 8'-0"
F	3'-0" x 7'-0"

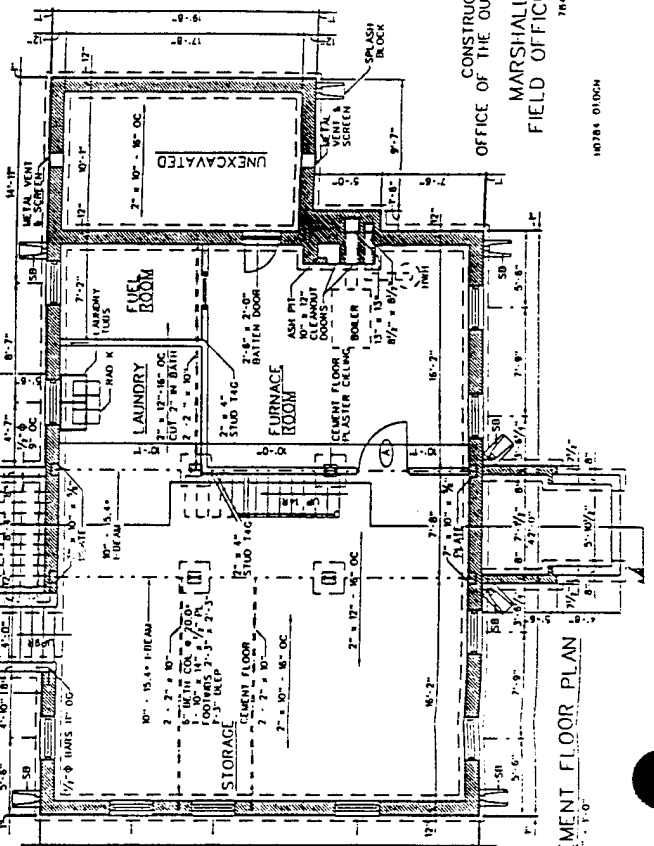

BASEMENT FLOOR PLAN
SCALE 1/4" = 1'-0"

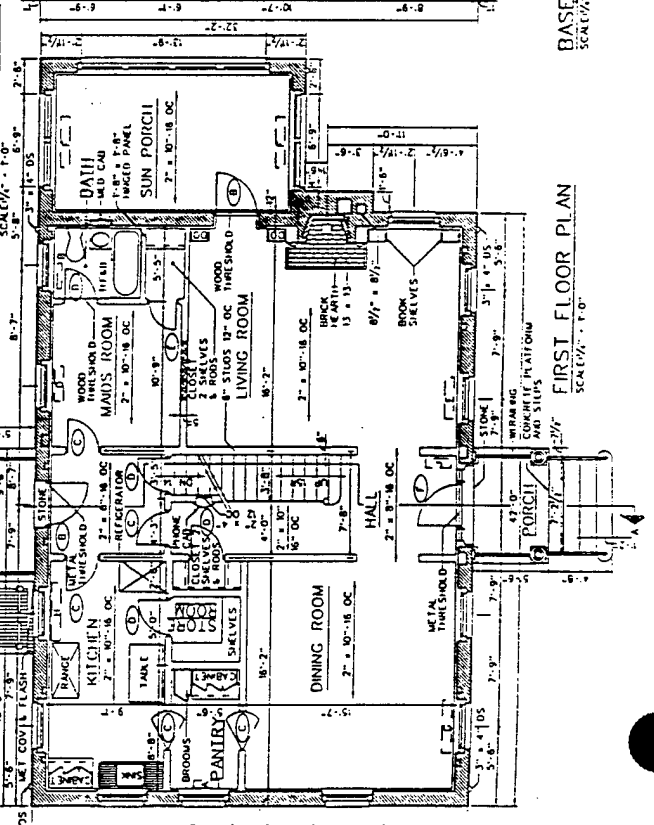

FIRST FLOOR PLAN
SCALE 1/4" = 1'-0"

REVISED
THIS PLAN CORRECT TO LAST
DISCREPANCY FOR BRICKWORK PRINTS
AUG. 30, 1953 - GENERAL REVISIONS

THIS DRAWING SUPERSEDES DWG
NO 625-1000
A-3-3

CONSTRUCTION DIVISION
OFFICE OF THE QUARTERMASTER GENERAL
MARSHALL FIELD, KAN
FIELD OFFICERS' QUARTERS

10784 01.004
784
AUG 25, 1953
625 1140

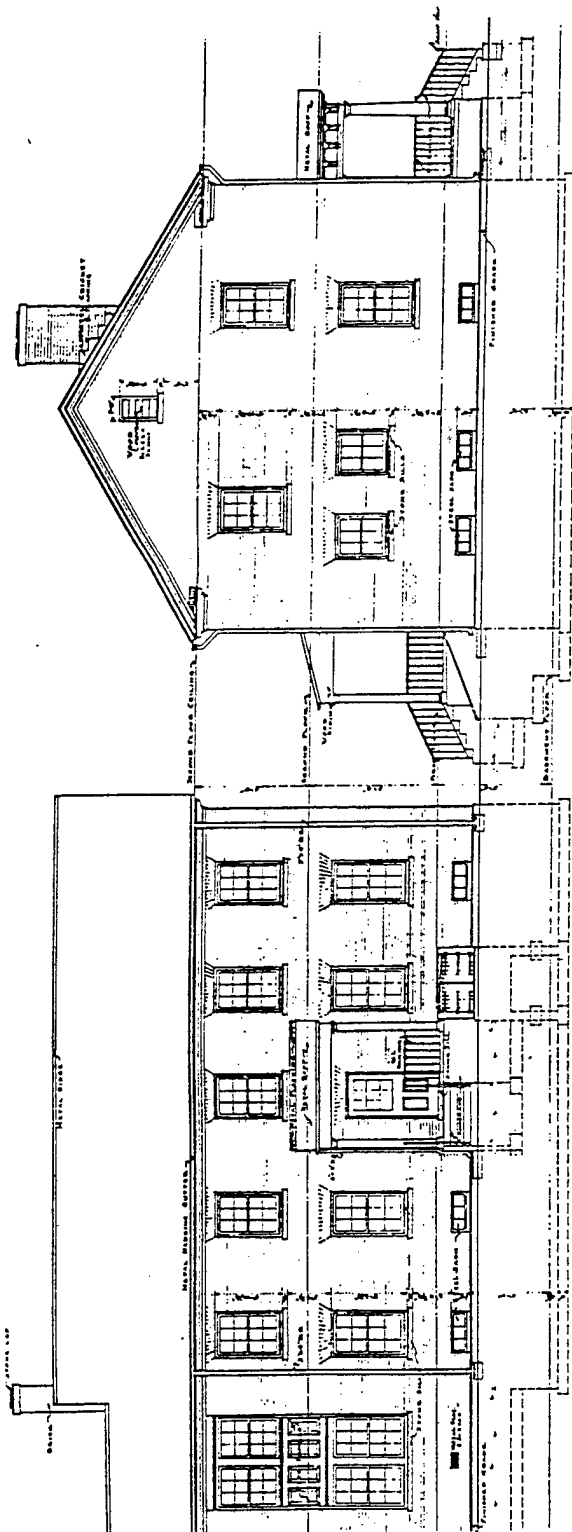

LEFT END ELEVATION

REAR ELEVATION

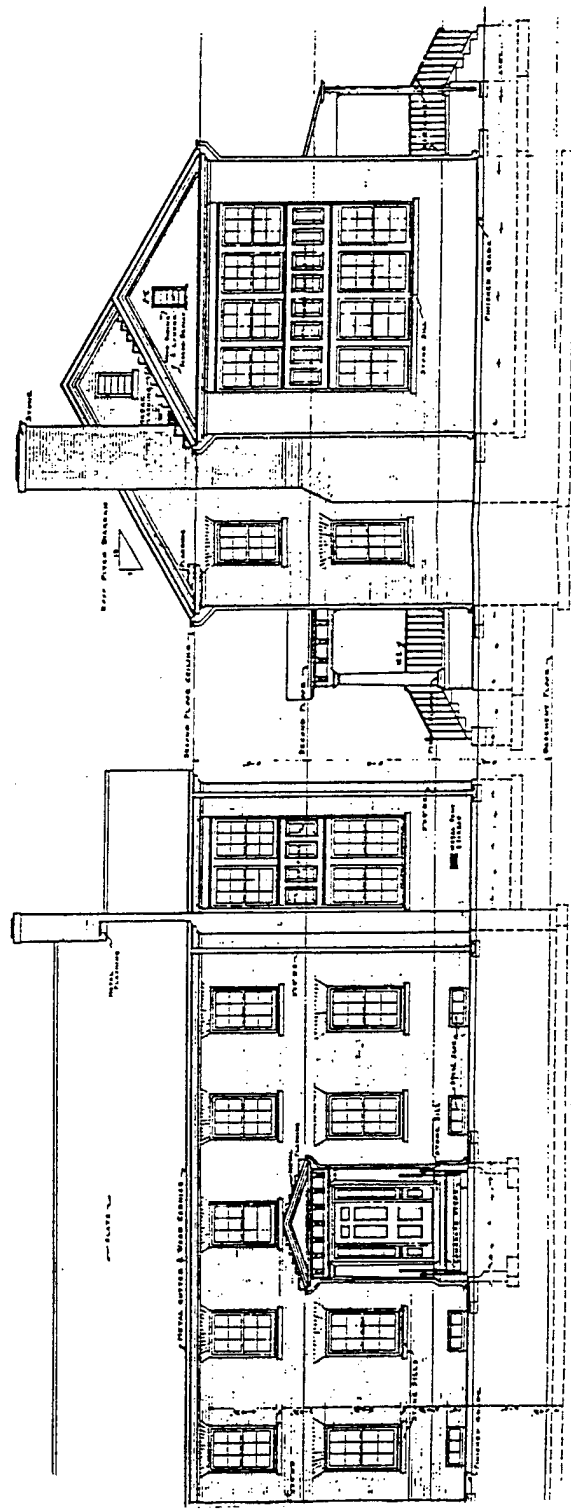

RIGHT END ELEVATION

FRONT ELEVATION

ALL WORK SHOWN IS TO BE DONE UNLESS OTHERWISE SPECIFIED IN THE NOTES.
 FOR ANY INFORMATION, SEE DRAWING NO. 625-1001.

SCALE: 1/4" = 1'-0"

CONSTRUCTION DIVISION
 OFFICE OF THE QUARTERMASTER GENERAL

FORT SULLY, WYOM.

FIELD OFFICERS' QUARTERS

DESIGNED BY <i>J. H. ...</i>	CHECKED BY <i>J. H. ...</i>	DATE <i>...</i>
DRAWN BY <i>J. H. ...</i>		PROJECT NO. 625-1001

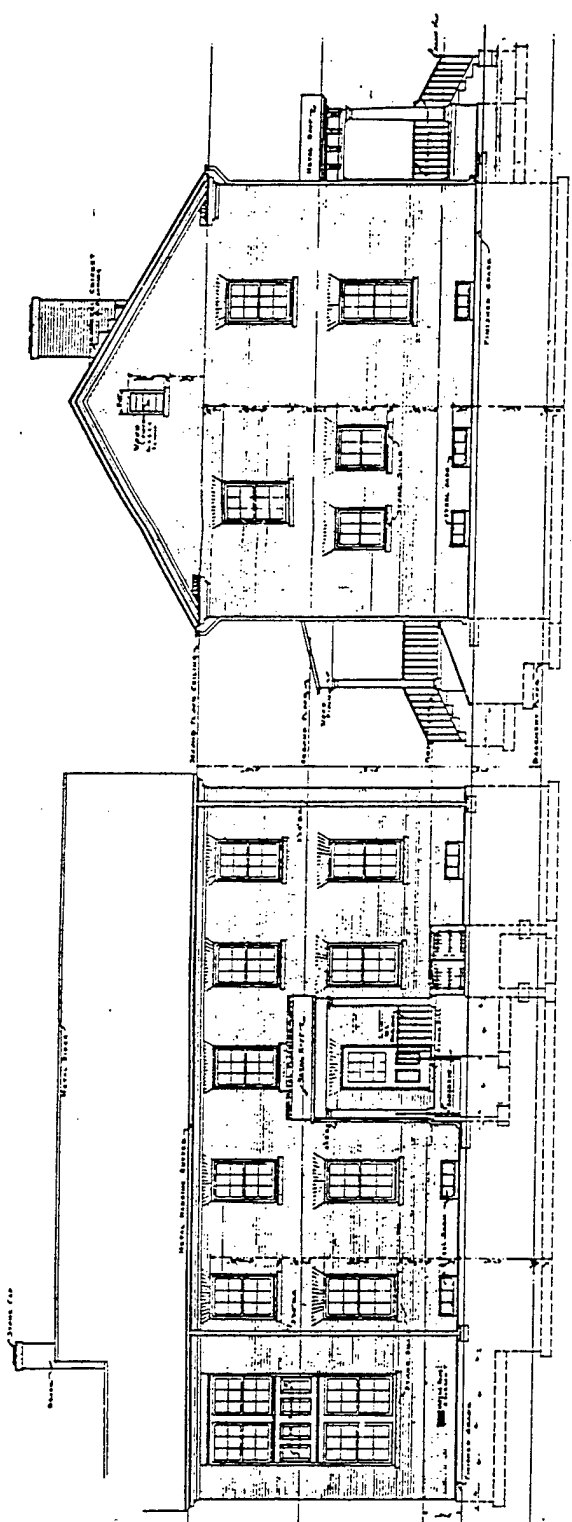

LEFT END ELEVATION

REAR ELEVATION

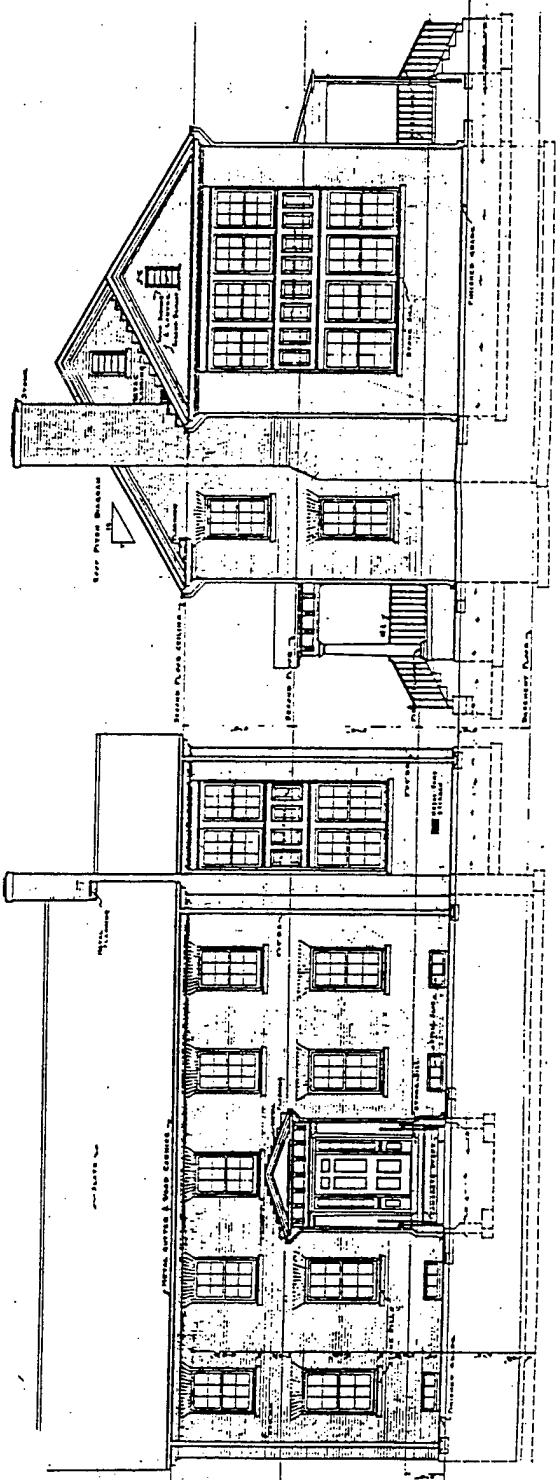

RIGHT END ELEVATION

FRONT ELEVATION

All work shall be in accordance with the specifications attached.
 See specifications, page No. 625-134B.

SCALE: 1/4" = 1'-0" A-4

OFFICE OF THE QUARTERMASTER GENERAL
 CONSTRUCTION DIVISION
 FORT RILEY, KAN.
 FIELD OFFICERS QUARTERS
 2114, No. 330-336

DESIGNED BY: [Signature]
 DRAWN BY: [Signature]
 CHECKED BY: [Signature]
 APPROVED BY: [Signature]

NO. 070-02.cit

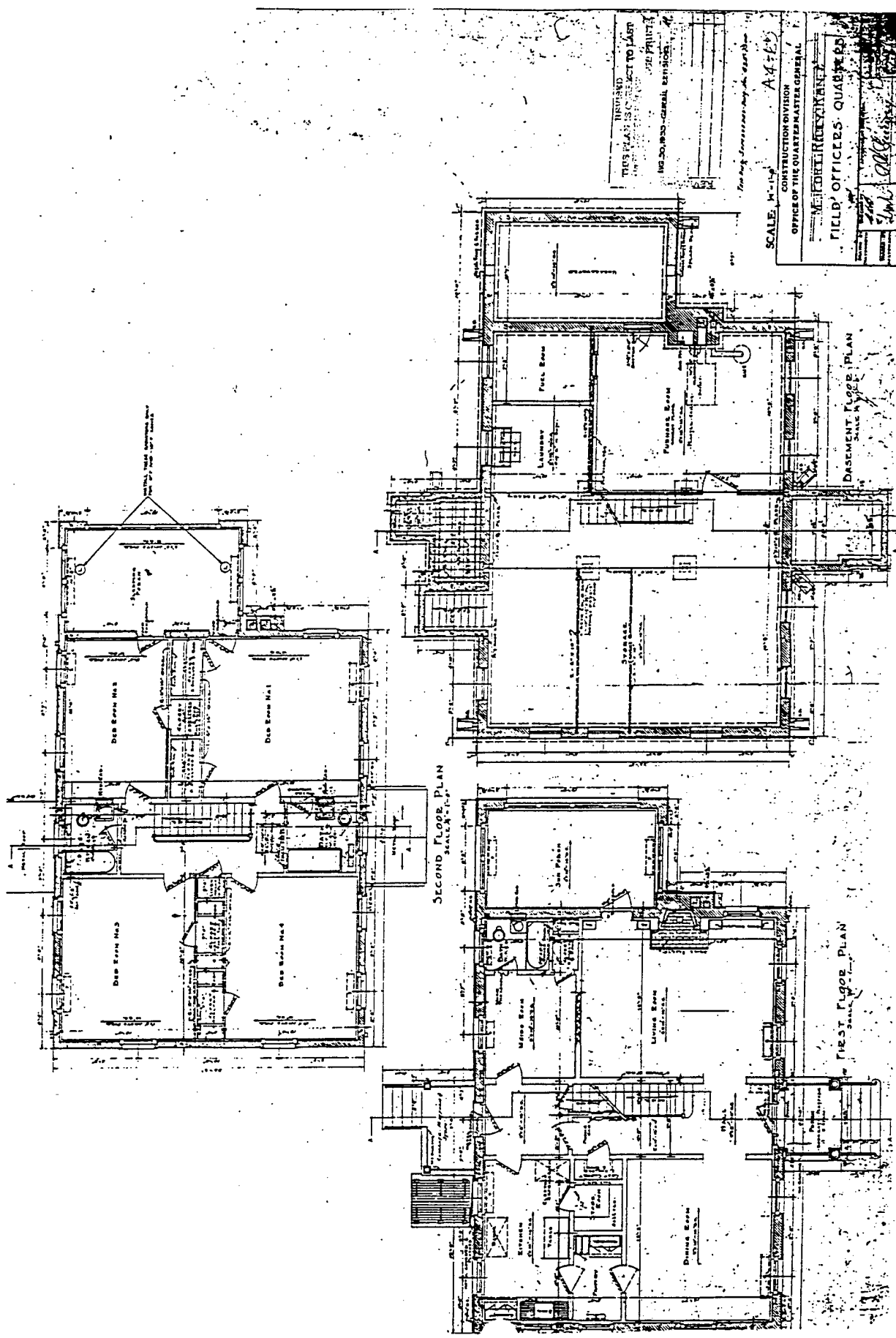

INVESTIGATE THIS PLAN IN CONNECTION WITH THE PROJECT

NO. 20, 1933 - GENERAL SERVICE

SCALE: 1/8" = 1'-0" A-4785

CONSTRUCTION DIVISION
OFFICE OF THE QUARTERMASTER GENERAL

FIELD OFFICERS' QUARTERS

DATE: 1/15/33

BY: [Signature]

h0 070.01.cit

*Proposed Field Officers Quarters
at
Fort Riley, Kans.*

Scale 1/4" = 1'

*Capt. Geo. E. Pond,
A.Q.M., U.S.A.*

*Note:
Staircase floor to be level with
outside floor, posts to be the
same length as shown.*



2-19-26.

Front Elevation Sheet # 11. U File A#-2

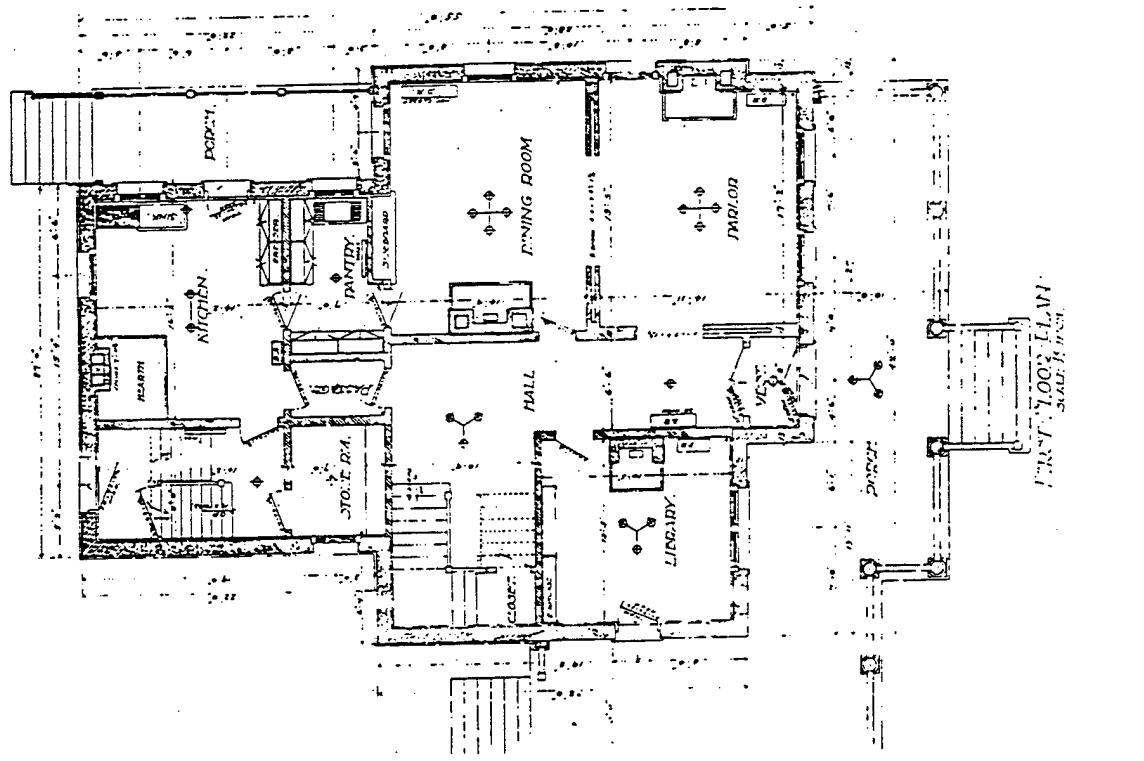
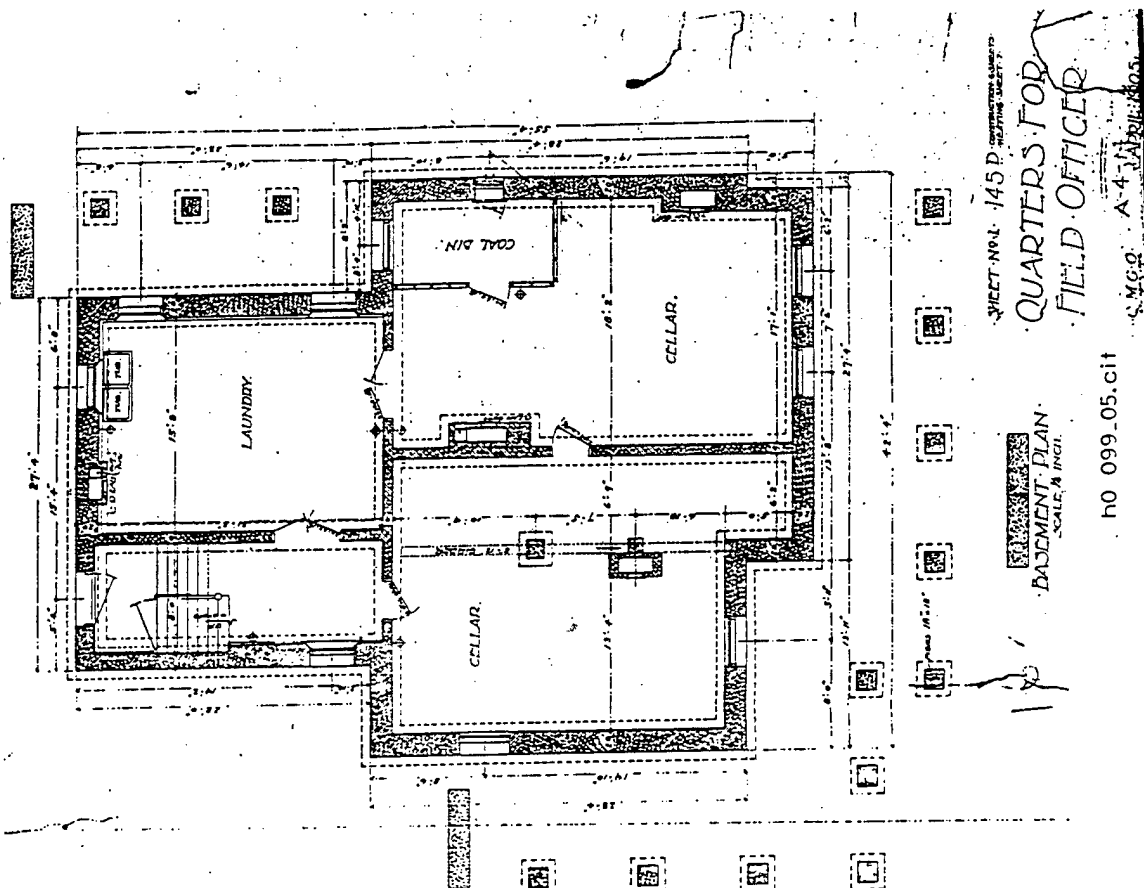

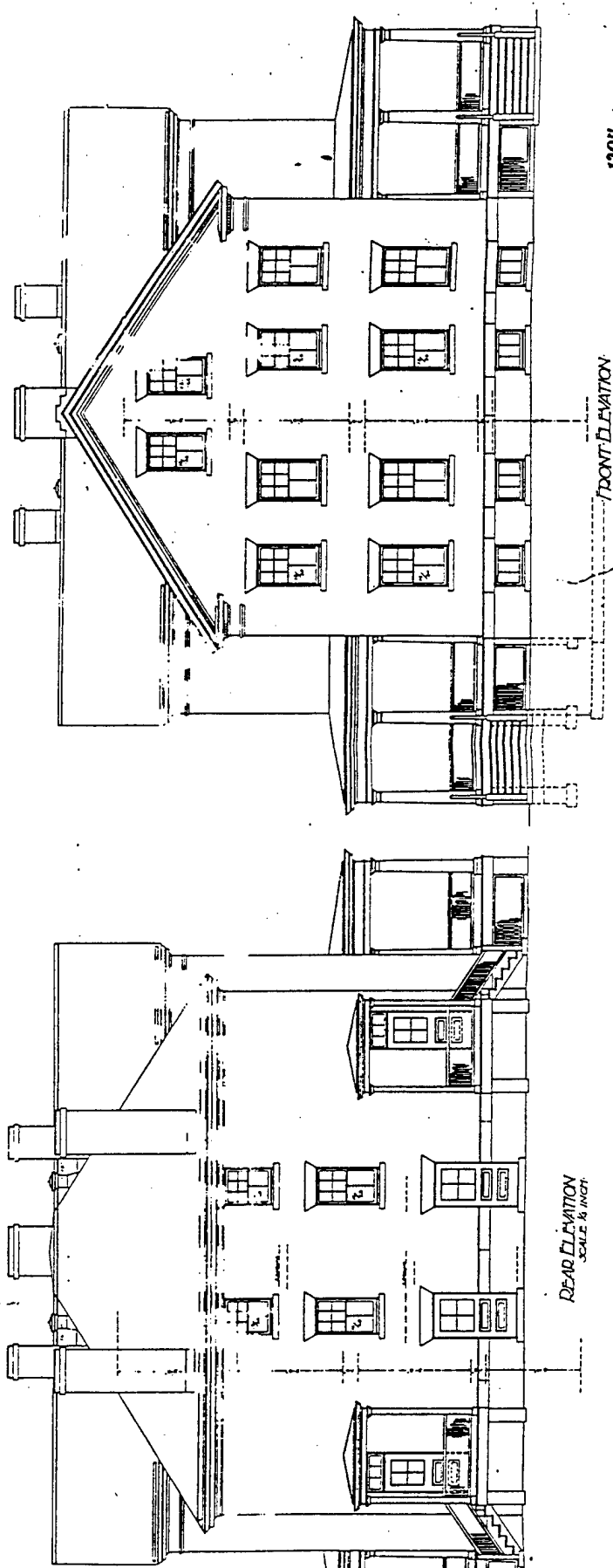

FRONT ELEVATION
SCALE 1/8" = 1'-0"

REAR ELEVATION
SCALE 1/8" = 1'-0"

12011
SHEET NO. 3
CONSTRUCTION & JERRETS
UNIVERSITY OF MICHIGAN
QUARTERS FOR TWO LIEUTENANTS
ANN ARBOR, MICH.
JUNE 1907
NO. 085-03-C11

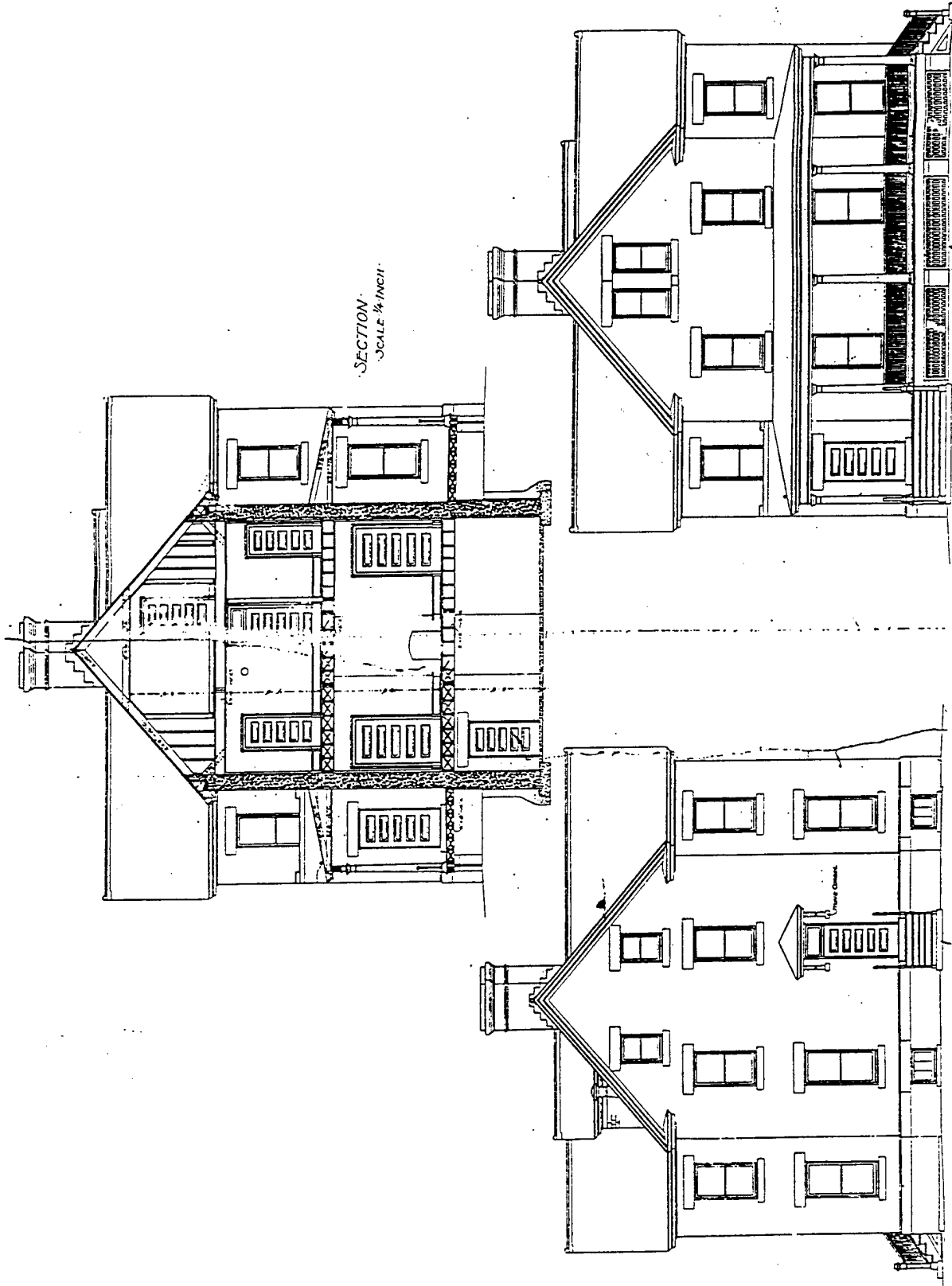

JPL 3-581
SHEET NO. 1 - 5 SHEETS
OFFICERS' QUARTERS
AGO # 77

HO 004_01.cit



SIDE ELEVATION
SCALE 1/4" = 1'-0"



SIDE ELEVATION
SCALE 1/4" = 1'-0"

SPL 3-387
SHEET NO 2 - 5 SHEETS
OFFICERS QUARTERS

HO 004.02.cit

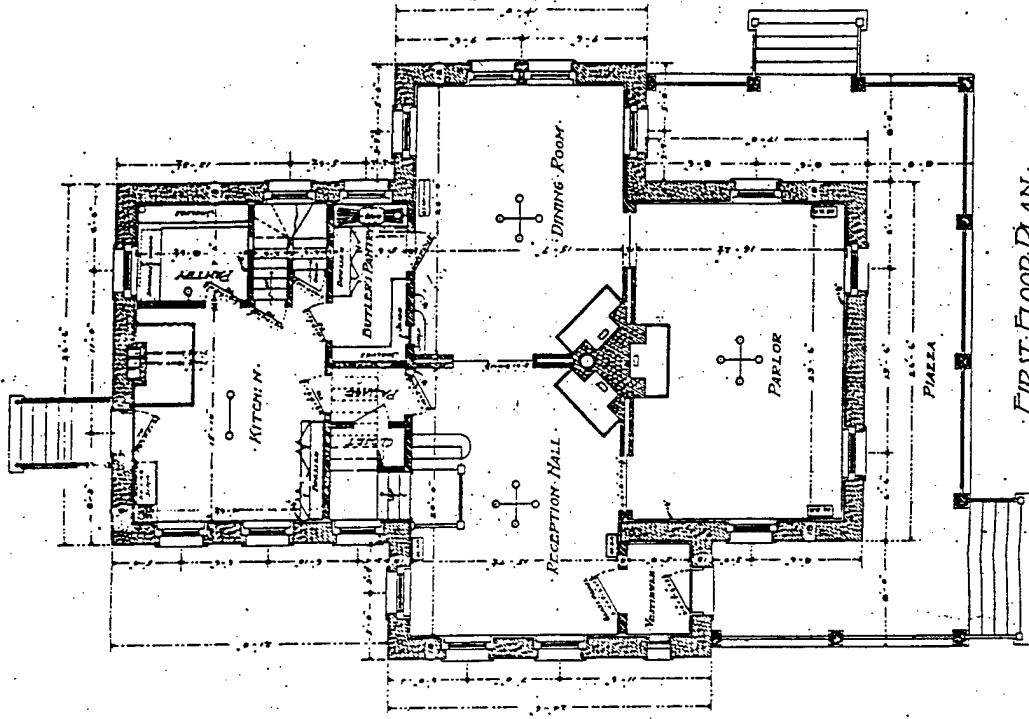

FIRST FLOOR PLAN

JPL 3381

SHEET NO 3 - 53 SHEETS

OFFICERS QUARTERS

Q.M.G.O. - FEB 1902

A 4

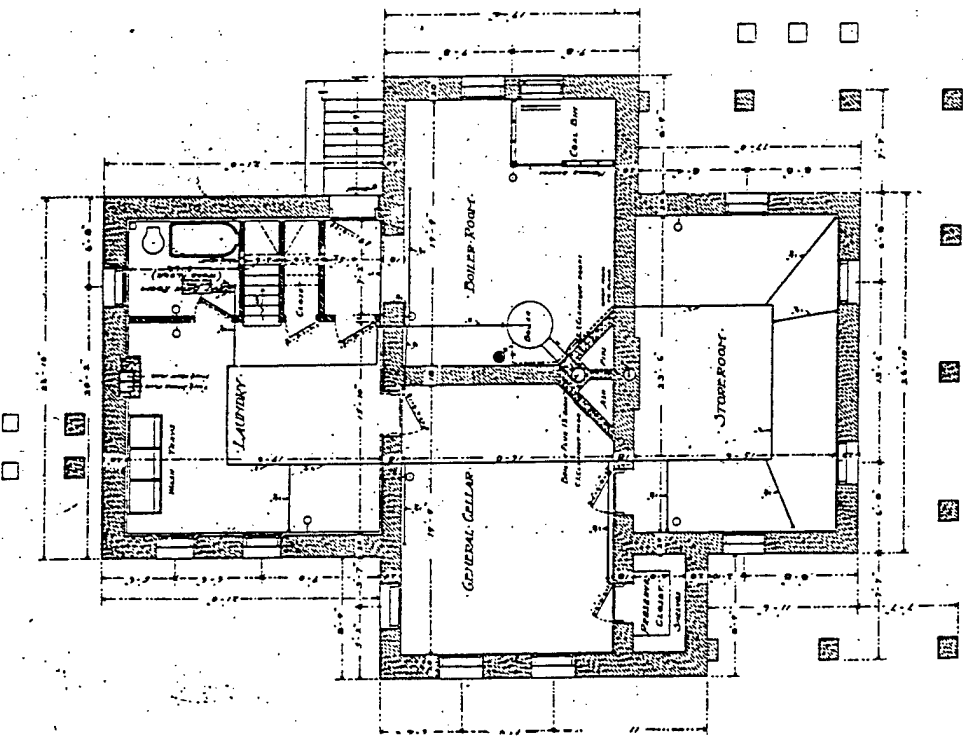

BASMENT PLAN

SCALE 1/4" = 1'-0"

SPL 3-318
DOUBLE QUARTERS FOR OFFICERS
AT Ft RILEY KANSAS
OMICA JAN-1904
SHEET No 4

HO 018-05.c11

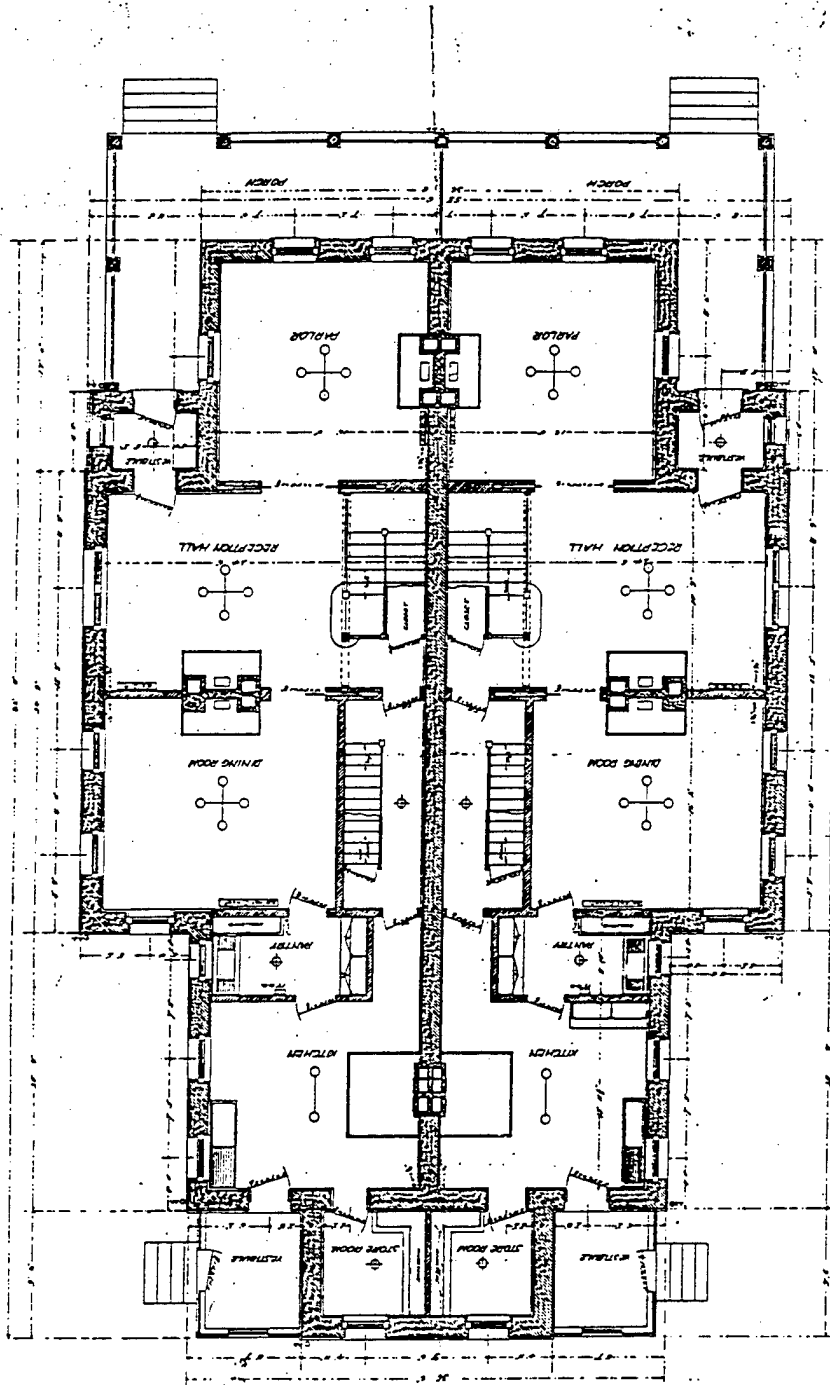

PLAN of First Floor
Scale 1/4" = 1'-0"

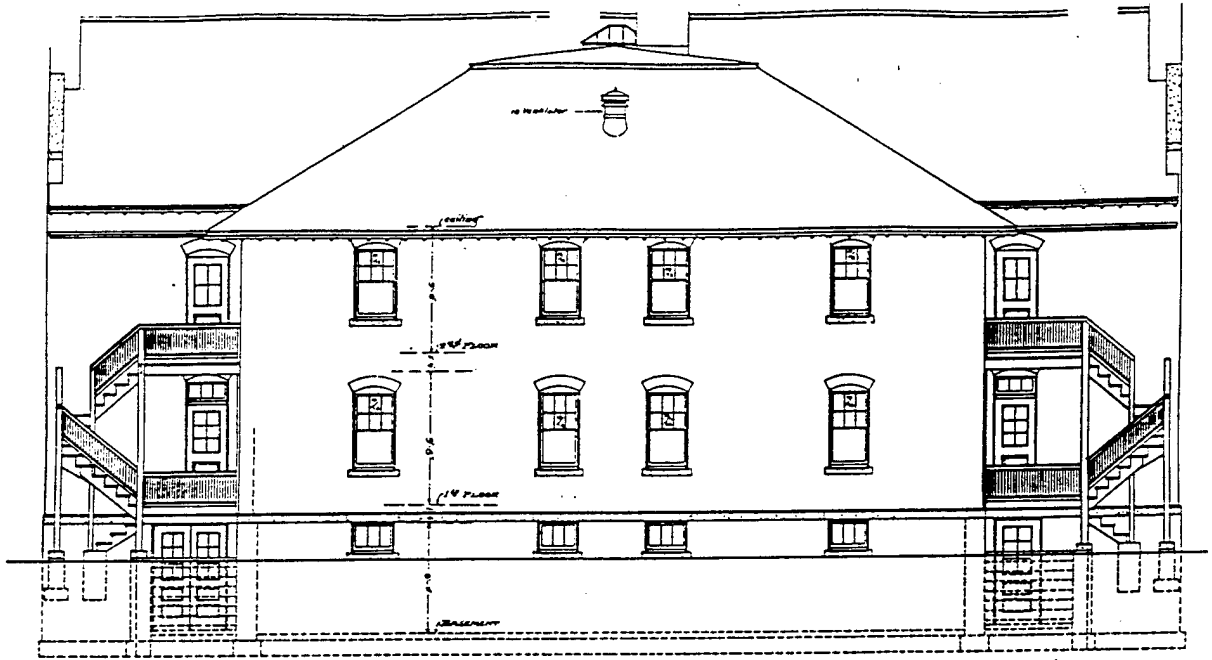

REAR ELEVATION.
SCALE 1/4 INCH.



END ELEVATION.
SCALE 1/4 INCH.



OFFICERS' QUARTERS
 2374
 MARCH 1903
 10100

CIRCUIT GROUPING
 GROUPING OF CIRCUITS TO BE MADE IN ACCORDANCE WITH THE FOLLOWING NOTES:
 1. ALL CIRCUITS TO BE GROUPED IN ACCORDANCE WITH THE FOLLOWING NOTES.
 2. ALL CIRCUITS TO BE GROUPED IN ACCORDANCE WITH THE FOLLOWING NOTES.
 3. ALL CIRCUITS TO BE GROUPED IN ACCORDANCE WITH THE FOLLOWING NOTES.

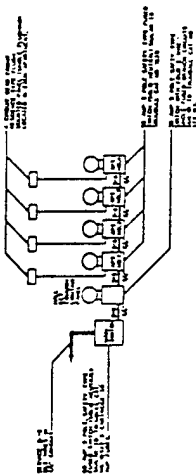

PLUMBING SYMBOLS & NOTES

1	2	3	4	5	6	7	8	9	10
11	12	13	14	15	16	17	18	19	20

1. ALL PLUMBING TO BE MADE IN ACCORDANCE WITH THE FOLLOWING NOTES.
 2. ALL PLUMBING TO BE MADE IN ACCORDANCE WITH THE FOLLOWING NOTES.
 3. ALL PLUMBING TO BE MADE IN ACCORDANCE WITH THE FOLLOWING NOTES.

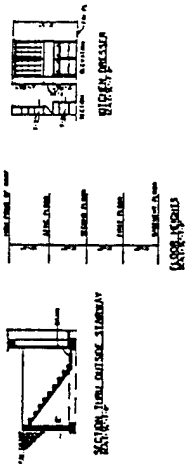

DESIGNED BY:	DATE:	PROJECT NO.:	SCALE:
DRAWN BY:	DATE:	PROJECT NO.:	SCALE:
CHECKED BY:	DATE:	PROJECT NO.:	SCALE:
APPROVED BY:	DATE:	PROJECT NO.:	SCALE:

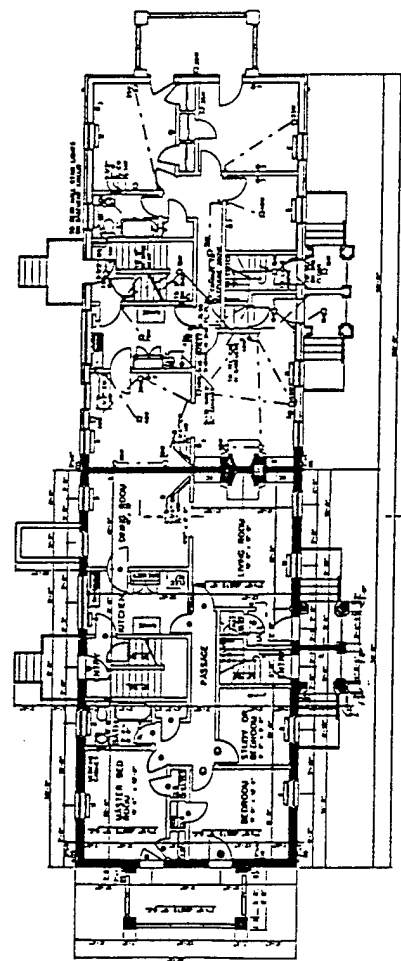

GROUND FLOOR PLAN

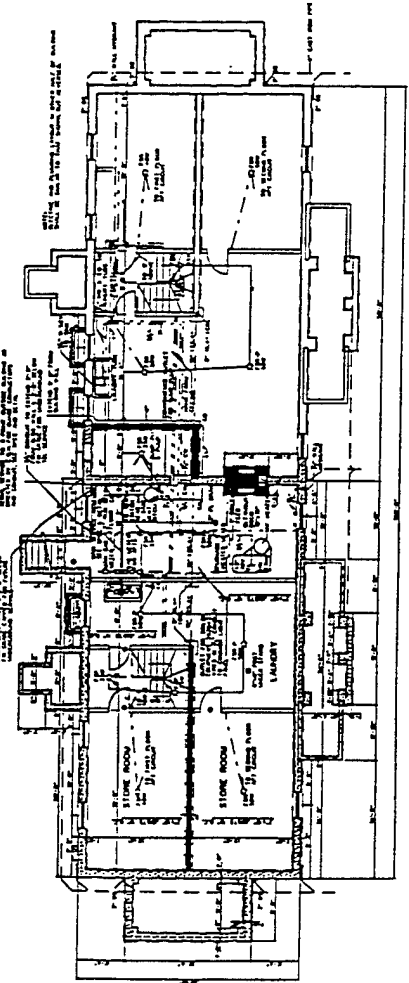

BASEMENT FLOOR PLAN

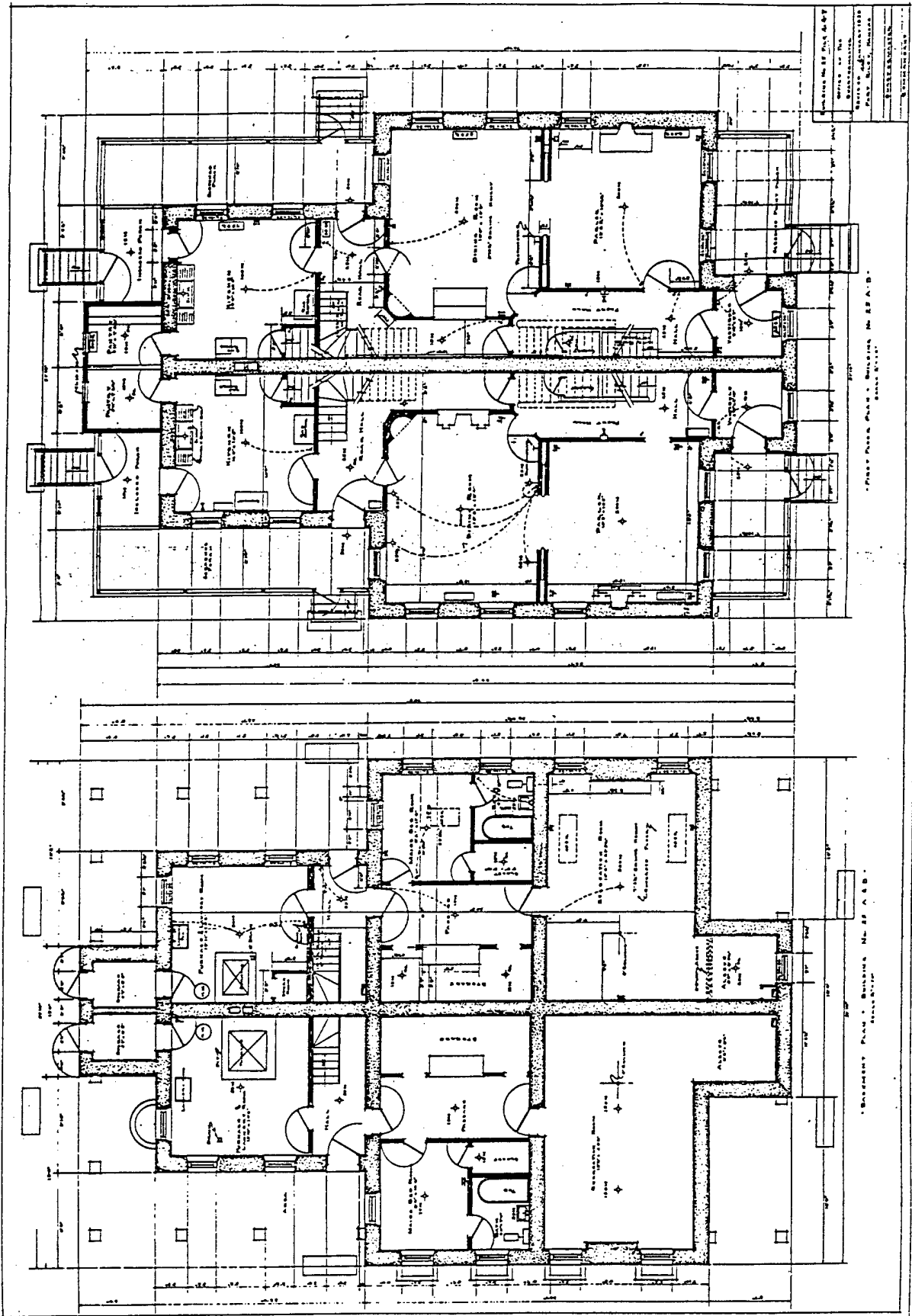

GENERAL PLAN - BUILDING NO. 111 - R.F.A.B. - SCALE 1/8" = 1'-0"

GENERAL PLAN - BUILDING NO. 112 - R.F.A.B. - SCALE 1/8" = 1'-0"

DRAWING NO. 111-112
 SHEET NO. 111
 INSTITUTIONAL BUILDING
 PARK, MISSOURI
 ARCHITECTS
 R.F.A.B.

NO. 020-12-GIT

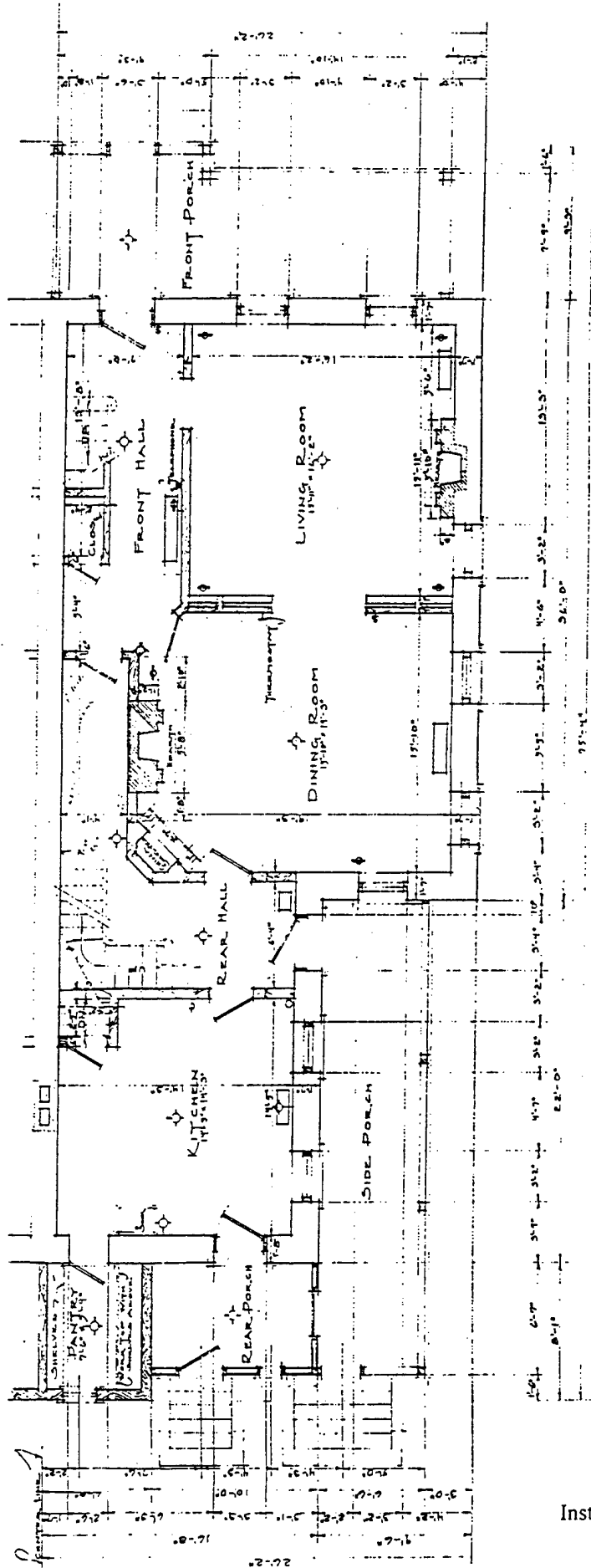

FIRST FLOOR PLAN
SCALE: 1/4" = 1'-0"

DRAWN BY: J. H. FURMAN
 Q.M.C. Post, Army Corps of Engineers
 Revision: Dec. 10, 1938
 QUARTERMASTER
 COMMANDANT
 16823.87.CIT

Category: RESIDENTIAL

Type 9 d-1: Family Housing Support Buildings: Garages

Description:

Garages were constructed behind family housing quarters starting in the early twentieth century, around the same time that they appeared in civilian communities. The one-story garages often matched the construction materials of the housing and usually displayed minimal architectural character or ornament. One-car, two-car, and shared multiple-car garages were constructed.

Evolution:

Private cars became popular during the early years of the twentieth century. By 1913, the Army Quartermaster Corps issued a standardized plan for a two-car garage. The plan depicts a garage clad in corrugated metal with two sets of paired side-hinged swinging doors leading to the interior space, which was open except for a corner storeroom for oil and gasoline. By 1915, the Quartermaster Corps issued a plan for multiple-car garages.²⁸ The earliest garages associated with private cars identified during the field survey conducted for this study were wood-frame buildings constructed during the 1920s. Often the early garages were constructed of salvage materials.

During the Army's inter-war construction program, private garages were included in family housing complexes of many new Army and Army Air Corps installations. Garages, usually for multiple cars, were constructed of the same materials as family housing and matched, though with simpler details, the general architectural style of the post. In general, garages were located behind officer and non-commissioned officer housing. During the late 1930s, the Construction Service of the Quartermaster Corps experimented with garages attached to family housing units. The Army also added garages behind officers rows at older posts; these garages usually were simple brick or wood frame structures.

Association:

Garages are minor support buildings in housing complexes. They are associated with the widespread use of the private automobile and incorporation of the car into domestic life. Garages do not possess individual significance, but may be contributing elements to an installation historic district, particularly where the garages were designed and constructed at the same time as the housing area in a compatible design.

²⁸ NARA, Cartographic Branch, RG 77, Standard Plans of Army Post Buildings, 1891-1918, Plans 313, 396.

Integrity:

Garages must retain their location and setting in relation to the housing for which they were built. Garages also should retain most of their design and materials from their period of construction. Garages constructed before 1940 often no longer serve their original function and are used as storage facilities. Exterior elements that may have been modified include roof and wall material and doors. In cases of subsequent additions or modifications, garages still may possess sufficient integrity to contribute to an historic district if they retain the majority of their relationship to the housing area, their overall design, and the majority of their materials and workmanship.

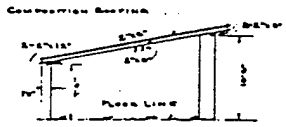

END ELEVATION
SCALE N^o 1/4"

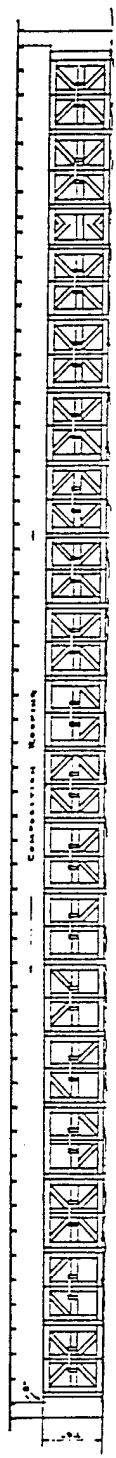

FRONT ELEVATION
SCALE N^o 1/4"

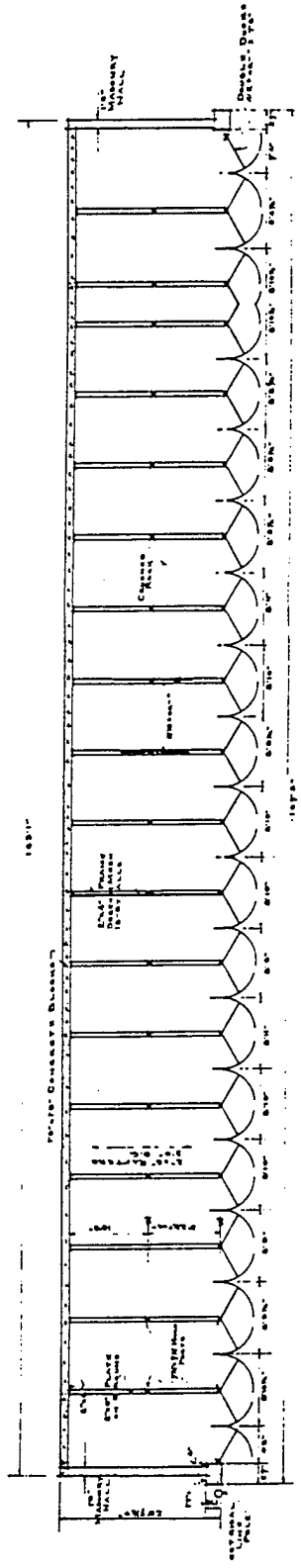

GROUND PLAN N.C.O. GARAGE
SCALE N^o 1/4"

DESIGN NO. 0047
IS GAR. GARAGE
FILE NO. A 207
OFFICE OF THE
QUARTERMASTER
REVISED JULY 1
FOOT RILEY NAME
QUARTERMASTER
COMMANDANT

10481217
NO 401.01.cit

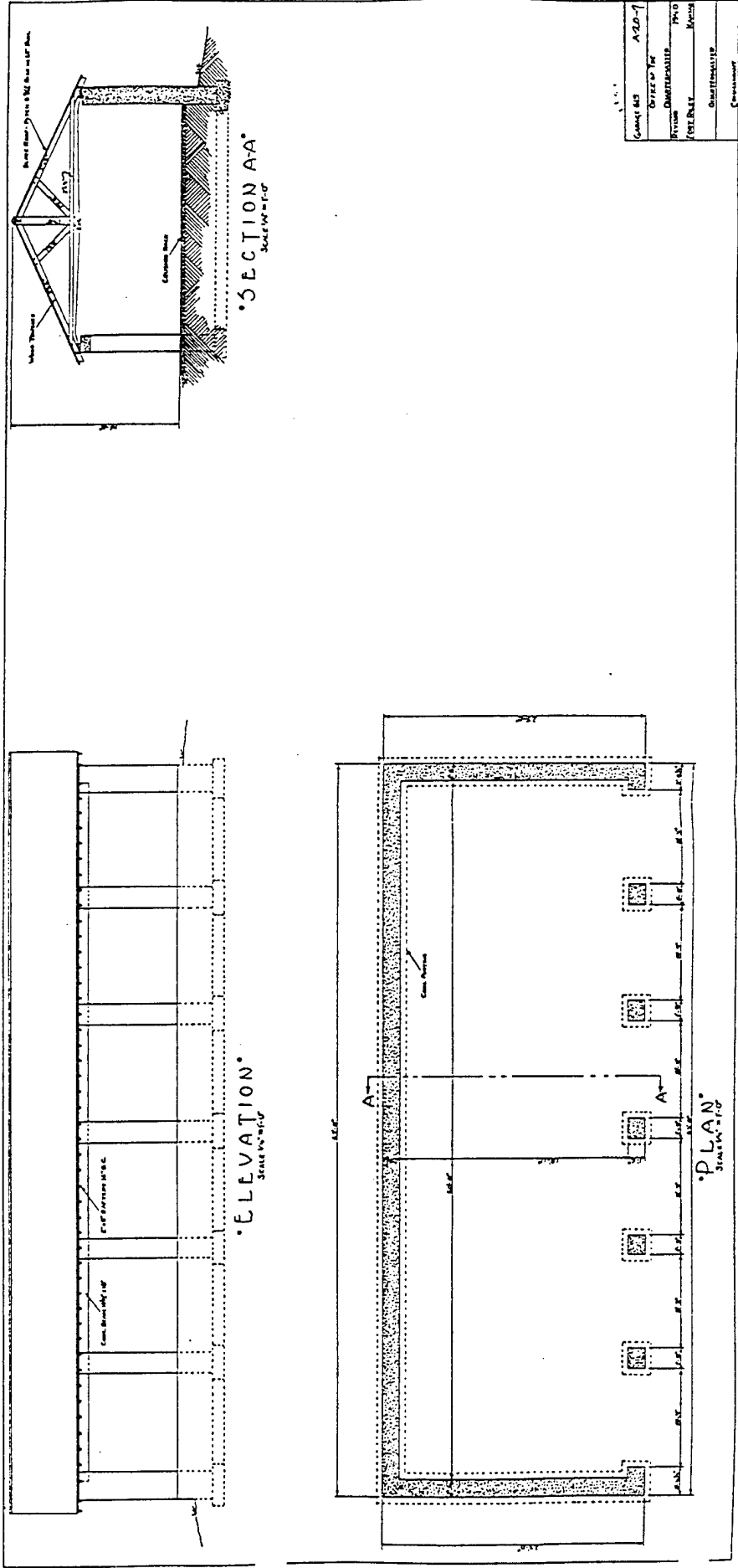

CONTRACT NO.	AS-20-7
DRAWN BY	GREENE
CHECKED BY	W. H. GREENE
DATE	1915
PROJECT	INSTITUTIONAL HOUSING
NO.	324
DATE	1915
BY	W. H. GREENE
CHECKED BY	W. H. GREENE
DATE	1915

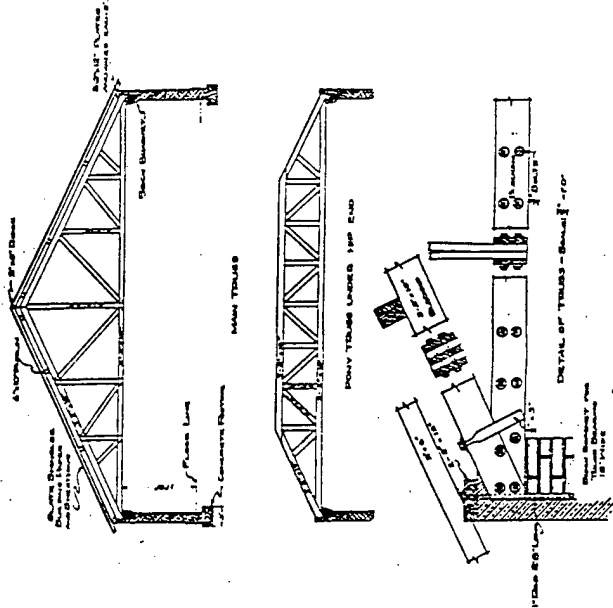
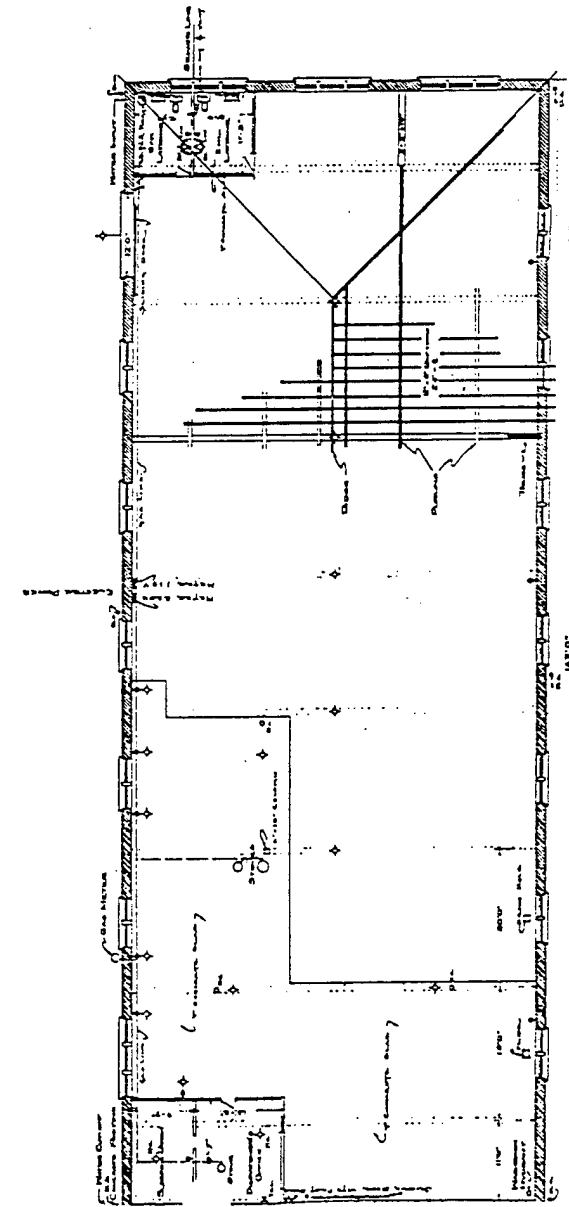
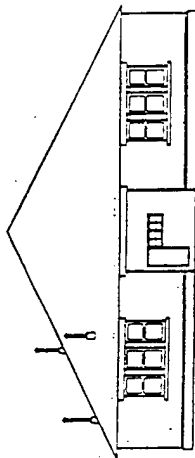
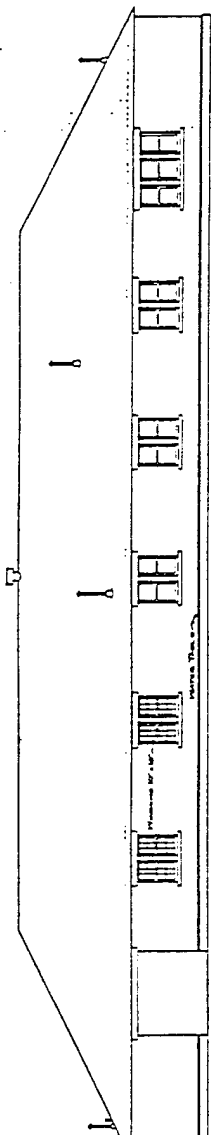

PARALIAK BROS. ARCHT. & ENGRS. INC. 110 N. 11TH ST. PHILADELPHIA, PA. 19107

FOR A 24-HOUR SERVICE CALL (610) 426-1100

PROJECT NO. 1001

DATE 10/1/77

DESIGNED BY PARALIAK BROS. ARCHT. & ENGRS. INC.

PHASE 1 TRUSS

CONTRACTOR: BOSTON UNITED DISTRICTS BROS. BLDG. CO.

Category: TRANSPORTATION

Type 10 a-1: Air-Related: Airplane Hangars

Description:

Military aviation before 1940 can be divided into two programs: heavier-than-air (HTA) aircraft, which included land planes and seaplanes, and lighter-than-air (LTA) aircraft, which included balloons, blimps, and dirigibles. Hangars were constructed to store and repair both types of aircraft. Airplane hangars were one-story buildings with gabled roofs, large entrances on the gable end, and large windows along the side elevations. Early hangars generally were constructed of wood frame; as the military aviation program expanded, steel frame and masonry hangars were constructed. Hangar size was related directly to aircraft size. Airplane hangars and their support buildings usually were located in a row near the installation flight line.

Evolution:

The U.S. Army Signal Corps first experimented with heavier-than-air craft in 1908 when the Wright brothers demonstrated their airplane for Army officials at Ft. Myer, Virginia. The Wrights opened a flying school in College Park, Maryland, to train a handful of Army aviators. Square, wood-frame, barn-like structures served as the hangars.

In 1911, the Quartermaster Corps issued its first standardized plan for a Signal Corps hangar. The plan depicts a square, 46 by 46 ft., wood-frame building with a segmental arched roof.¹ The walls were clad in board-and-batten wood siding. One elevation consisted of six large doors: the end doors were hinged, the middle doors slid on overhead tracks. By the end of October 1912, the Army owned eleven planes, nine of which were in operation.²

During the early years of Army aviation, despite the existence of standardized plans for hangars, pilots often made do with primitive airfield facilities. In 1913, the Signal Corps moved its flying school from College Park to Glenn Curtis' flying school at North Island, San Diego, California. The Signal Corps Aviation School at North Island first consisted of an "old barn and shed, left over from some earlier activity, and a canvas hangar and lean-to without floors and doors put up by the army to house the ... planes."³

The National Defense Act of 1916 raised appropriations for military spending. The 1916 National Defense Act included funding for construction of Langley Field, near Hampton, Virginia, which was designed as a testing facility for the National Advisory Committee for Aeronautics and the military. In January 1917, the Signal Corps selected noted industrial architect Albert Kahn as Architect-in-Chief of the Army Signal Corps; Kahn and his firm began

¹ National Archives and Records Administration, Cartographic Branch, Record Group 77, Standard Plans of Army Post Buildings 1891-1918, P.I. NM-1 9, Entry 411, Plan 295.

² United States Air Force, Historical Division, *The United States Air Arm, April 1861-1917*, USAF Historical Study No. 98, Maxwell AFB, Alabama, Air University, 1958, 73.

³ United States Air Force, Historical Division, *The United States Air Arm, April 1861-1917*, 86.

work on the design of a permanent airfield at Langley in 1917. On the eve of American involvement in the World War I, the Army had seven flying fields in the continental United States: San Diego, California; Ft. Sam Houston, Texas; Mineola (Hazelhurst), New York; Ft. Sill, Oklahoma; Chandler Field, Pennsylvania; Langley Field, Virginia; and Kelly Field, Texas. The Army also operated an airfield in the Philippines and one in Hawaii.⁴ No structures predating 1917 remain on those installations still under federal ownership.

In April 1917, the United States entered World War I. The rate of permanent construction slowed as resources were devoted to the construction of wartime mobilization cantonments. Albert Kahn developed standardized plans for temporary airfields; he completed the basic airfield design in ten days in May 1917. The plan for a standard single-unit training field required 54 buildings and accommodated 100 aircraft, 150 student pilots, and the training cadre. The airfield layout was based on a one-mile-square section, with all buildings situated in a row on one side of the runway.⁵ This basic linear design pattern was implemented for early Signal Corps mobilization fields, such as Scott Field, Illinois, and Selfridge Field, Michigan.

An intact, World War I hangar remains standing at Brooks AFB, Texas. This airfield, originally called Kelly Field #5, was laid out according to a 1917 Albert Kahn plan. The hangar is a wood-frame building with a gambrel roof and sliding doors on tracks that extend beyond the building. The Army also constructed metal hangars to supplement wood-frame airfield facilities. At Kelly Field #5, an all-steel, 66-foot wide hangar was constructed. Metal hangars had the advantage of portability and could be mass-produced. The Quartermaster General's Office issued new standard plans for hangars in 1917. These plans depict a metal frame structure with galvanized, corrugated iron walls and doors along the gable and elevations of the building.⁶

In addition to the temporary mobilization camps, the Army proceeded with two permanent airfield projects, Langley Field and Rockwell Field, California, both designed by Albert Kahn. At Langley, permanent brick hangars were completed by 1919. These hangars incorporate decorative terra cotta and brickwork similar to other Kahn projects for civilian installations in Michigan. The Langley hangars display the large corner piers that later became a characteristic feature of Army hangar design. In 1917, a joint Army-Navy board selected North Island in San Diego as the site for an aviation school to train desperately needed pilots. The Army portion was designated Rockwell Field. Kahn designed the buildings in a simplified Spanish Mission revival style. Three hangars were constructed of reinforced concrete and hollow clay tile, finished with stucco, and topped with clay-tile roofs. Military architects and planners repeatedly used Spanish Mission style elements in the design of hangars, and other utilitarian buildings, during the inter-war years, particularly in San Diego and throughout the southwest.

⁴ Jerold E. Brown, *Where Eagles Land: Planning and Development of U.S. Army Airfield 1910-1941* (Westport, Connecticut, Greenwood Press, 1990), 30.

⁵ Jerold E. Brown, *Where Eagles Land*, 39.

⁶ Duane E. Peter, et al., *Phase 1: Cultural Resources Overview of Brooks Air Force Base, San Antonio, Bexar County, Texas*, Draft MSS, Civil Engineering, Brooks AFB, San Antonio, Texas, February, 1992, 111-53; NARA, Cartographic Branch, RG 77, Standard Plans of Army Post Buildings, 1891 - 1918, Plans 398, 426 - 429.

After the end of World War I, no appropriations were available for airfield improvements; Langley and Rockwell remained the only airfields with permanent facilities. Army aviators continued to use deteriorating mobilization airfields and wood-frame hangars. The Air Corps Act of 1926 authorized the expansion of Army aviation; the Chief of the Air Corps proposed improvements at 32 fields and construction of two other fields as part of a five-year plan. The years from 1926 to 1932 marked some of the first permanent construction and physical improvements of aviation facilities.⁷

Under this expansion program, World War I wooden hangars were replaced with fireproof hangars constructed of steel frame clad with brick or stucco-covered hollow clay tile. The typical hangar constructed in the early 1930s was rectangular, with a gable roof, distinct corner piers, concrete floor, steel sash windows along the side elevations, and sliding metal doors on overhead tracks at the gable end. The roofs often were painted in alternating light and dark squares. Hangars completed at Randolph Field, Texas, in 1931 were 113 by 220 ft. and had capacity for 30 planes.⁸ Hangars of this type were constructed singly or attached as pairs; single hangars generally were oriented with their gable ends perpendicular to the flight line, while paired hangars faced the flight line. A double hangar at Barksdale Field, Louisiana, measured 243 by 120 ft. and accommodated 52 planes.⁹

Army hangars constructed in 1934 and later had segmental-arch roofs supported by steel bowstring trusses. The arched roof form offered greater interior height. Hangars of this type have larger corner piers than their gable-roofed predecessors. In some cases, the control tower was incorporated into the top of the corner pier nearest the runway. A double hangar of this type at Pope Field, North Carolina, was 333.5 by 124 ft. and contained storage facilities, toilets, locker room, shop, gunnery, and radio room.¹⁰

By the end of the 1930s, aircraft design had changed greatly as airplanes increased in size and wingspans grew wider. New hangars were larger to accommodate the airplanes' increasing size. By the late 1930s, the Army had simplified some of its hangar designs, deleting stylistic references and the distinctive corner piers. Metal cladding over the steel frame replaced the characteristic masonry of the early and mid 1930s; the sliding doors were steel sash; and, the side elevations were blank. After the start of World War II mobilization, use of steel was restricted to weapons and other essential industrial production; the Army once again turned to wood-frame hangars to house its rapidly expanding air force. A few airfields received permanent hangars during the early 1940s, including Ft. Knox, Kentucky, and Wright-Patterson, Ohio. These hangars retained the segmental-arch roof, steel-sash sliding doors, and masonry-clad steel frame construction of early hangars; however, their size dwarfed earlier hangar construction.

⁷ Brown, *Where Eagles Land*, 73-89.

⁸ NARA, Suitland, Federal Records Center, RG 77, Historical Record of Buildings, 1905 - 1942, Randolph AFB, Texas.

⁹ NARA, Suitland Federal Records Center, RG 77, Historical Record of Buildings, 1905-1942, Barksdale, AFB, Louisiana.

¹⁰ Lesley M. Drucker, "Architectural and Historical Documentation of the Original Cantonment Area and Hangars 4 and 5, Pope Air Force Base, North Carolina," Resource Studies Series 83, Carolina Archeological Services, MSS, Civil Engineering, Pope AFB, North Carolina, 1985, 23.

The expansion of the Air Corps and its facilities during the 1930s prompted the development of supporting structures around the hangars and flight line. Ground support buildings typically included control tower, repair shops, dope (lubricant or varnish) and paint shops, and storage facilities. These supporting facilities often were constructed in materials and designs similar to or compatible with the adjacent hangars, though their utilitarian functions were the primary determinant of their design and location.

Association:

Airplane hangars and their attendant support structures are associated directly with the evolution of military aviation. Aviation is a significant development in military tactics and strategy and is associated with the development of the military, starting immediately before World War I. Hangars also are associated with the theme of technology. Hangars are a distinct property type that evolved over time in response to the development of aircraft design.

Many military installations have aviation facilities. Depending on the role of aviation in the installation's historical mission, the hangars and support structures may consist of one or two small, utilitarian buildings or may constitute a major component of the installation. Aviation supported the primary mission at some installations, while at other installations, aviation was the primary installation activity. A hangar may possess individual significance for architectural or engineering merit, or may contribute to an installation historic district that represents the theme of military aviation or a distinguishable entity. Associated support facilities such as storage buildings, repair shops, control towers, aprons, or run ways may constitute important contributing features to an historic district.

Integrity:

Many smaller, older hangars have been converted to new uses, while some larger hangars from the late 1930s continue to function as airplane hangars. To possess integrity, hangars and their support structures should retain most of their architectural and engineering design features and external construction materials from their period of construction. Character-defining features include the overall shape of the building, original construction materials, fenestration on the side elevations, large door openings and sliding doors at the end elevations, and corner piers. Exterior elements that may have been modified include doors and windows; if replacement doors and windows retain the same placement and similar materials as the originals, and the hangar still conveys the overall design from the period of significance, it may still possess integrity. Small, ancillary additions that do not overwhelm the basic block of the hangar do not diminish substantially the building's integrity. If the building is under consideration for nomination to the National Register as an individual building, rather than as part of an historic district, the interior should retain sufficient integrity to convey the construction and interior configuration of the hangar during its period of significance. An historic district composed of hangars and their support buildings does not need to retain the interior integrity and may better represent the theme of aviation than isolated hangars that once were part of a complex of buildings.



1938-39 Airplane Hangar 1 at McChord AFB, WA

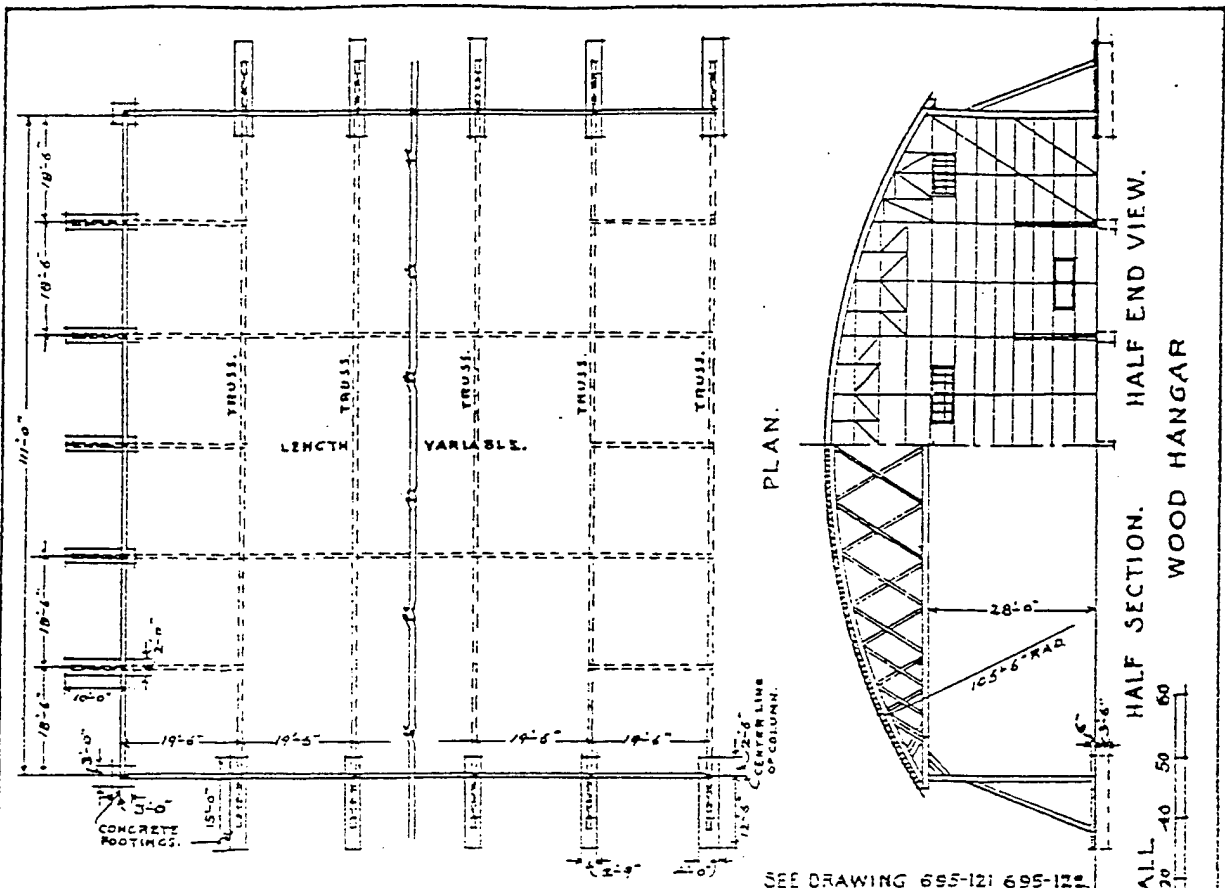

HALF SECTION. HALF END VIEW. WOOD HANGAR

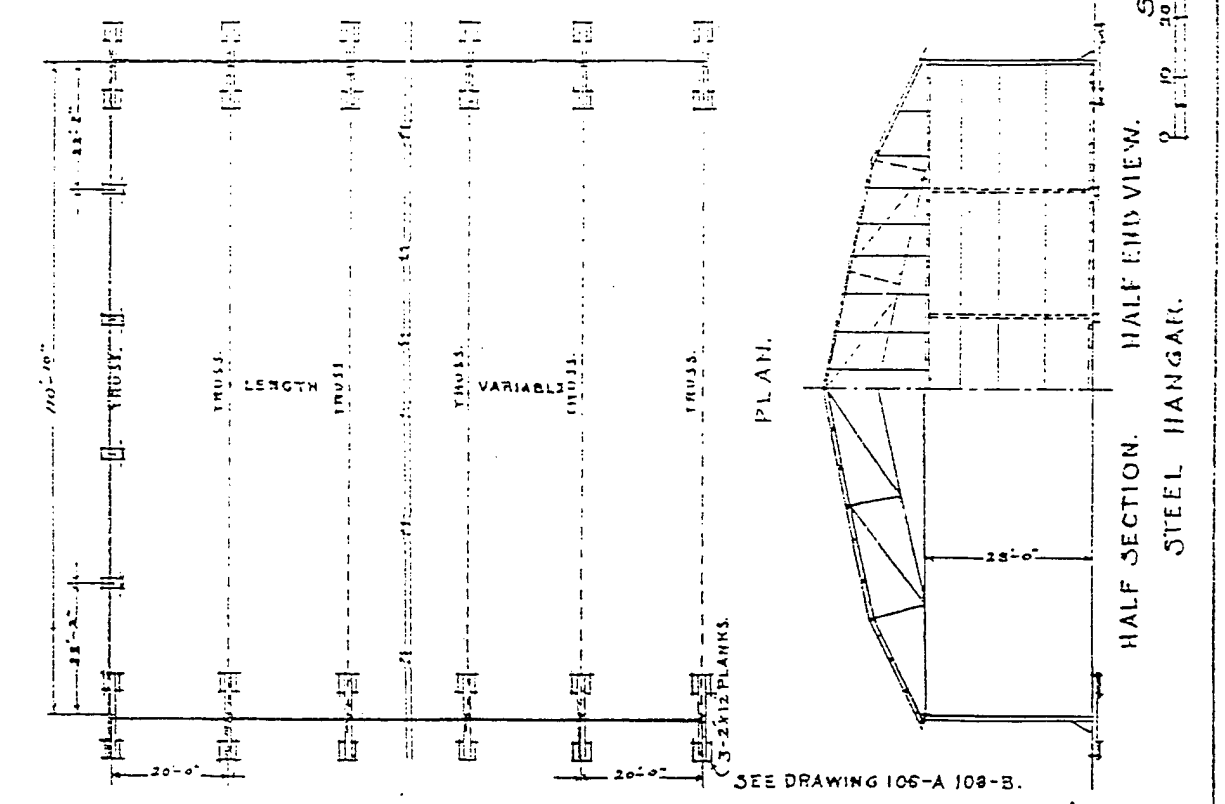

HALF SECTION. HALF END VIEW. STEEL HANGAR.

CONSTRUCTION DIVISION OF THE ARMY. SB-9
 STANDARD STEEL & WOOD HANGARS

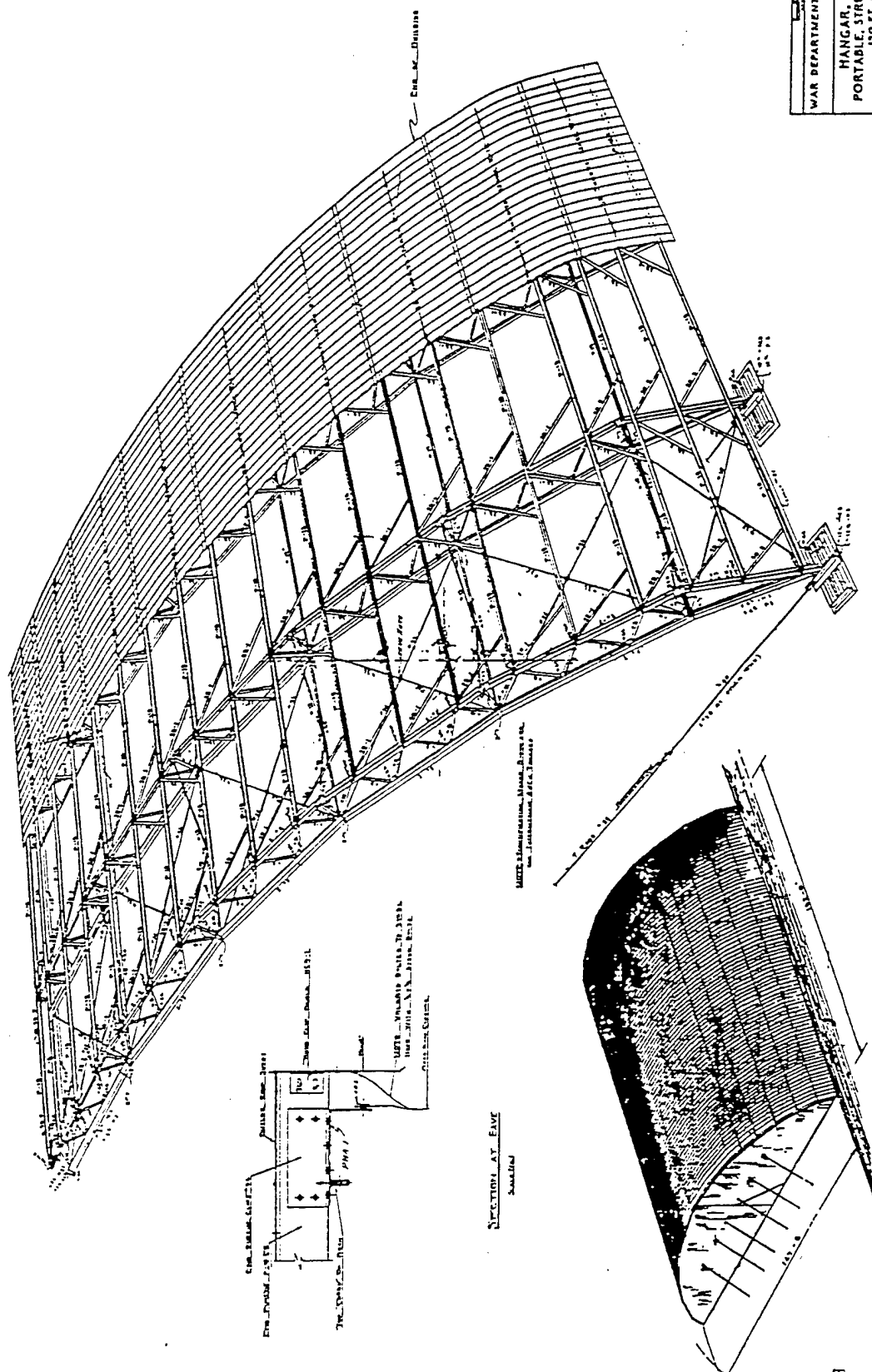

WAR DEPARTMENT TECHNICAL MANUAL
 HANGAR, AIRPLANE
 PORTABLE, STRUCTURAL STEEL-
 130 FT - 100 FT
 STEEL COVER, FIBER GLASS BOARDS
 PERSPECTIVE VIEW OF HANGAR
 SECTION DRAWING E-101

ROOF SHEETS - BUTLER MFG CO TYPE-CORRUGATED-12" ON CTRS.
 SEE DRAWING FOR TYPE F 1004 FOR 3" CORRUGATED TYPE

h1980_01.cit

H1980-01.cit

HANGAR

1234567890

1. From Coll. No. 64.
 2. From Coll. No. 105.
 3. From Coll. No. 106.
 4. From Coll. No. 107.
 5. From Coll. No. 108.
 6. From Coll. No. 109.
 7. From Coll. No. 110.
 8. From Coll. No. 111.
 9. From Coll. No. 112.
 10. From Coll. No. 113.
 11. From Coll. No. 114.
 12. From Coll. No. 115.

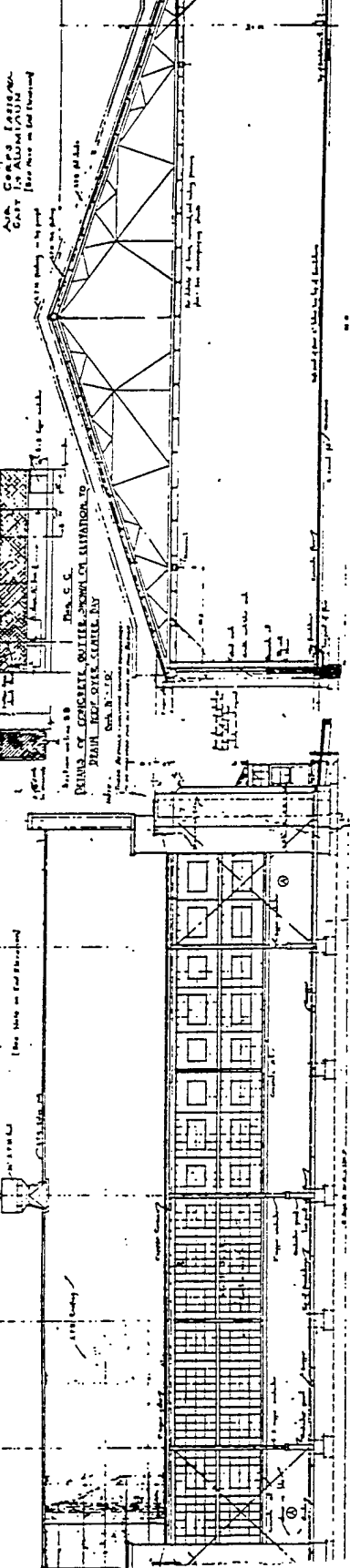
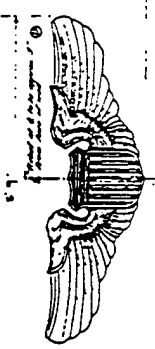

SIDE ELEVATION
 Scale 1/8" = 1'-0"

SECTION ON LINE W-W
 Scale 1/8" = 1'-0"

INSIDE PART OF REAR END ELEVATION
 Scale 1/8" = 1'-0"

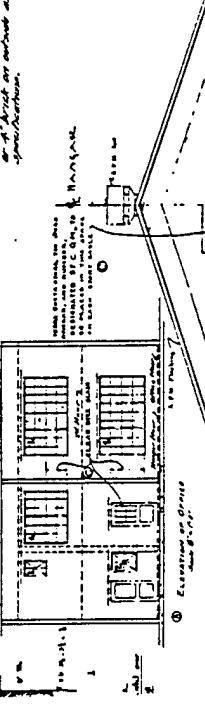
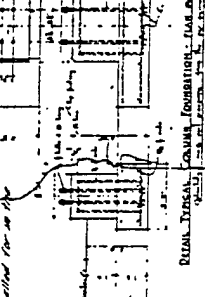
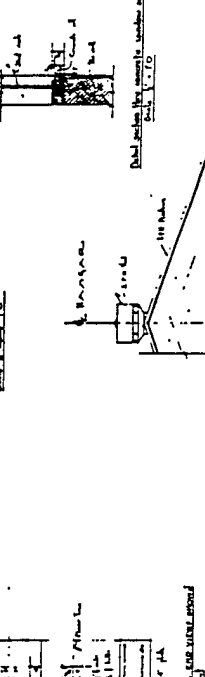

INSIDE PART OF REAR END ELEVATION
 Scale 1/8" = 1'-0"

ELEVATION OF FRONT END
 Scale 1/8" = 1'-0"

OUTSIDE PART OF FRONT END ELEVATION
 Scale 1/8" = 1'-0"

SCALE AS NOTED

CONSTRUCTION SERVICE
 OFFICE OF THE QUARTERMASTER GENERAL

AIR CORPS HANGAR
 [1930-B DESIGN]
 ELEVATIONS, SECTION AND DETAILS

DATE: 1/13/31
 DRAWN BY: [Signature]
 CHECKED BY: [Signature]
 APPROVED BY: [Signature]

695-272
 10741.07.G1

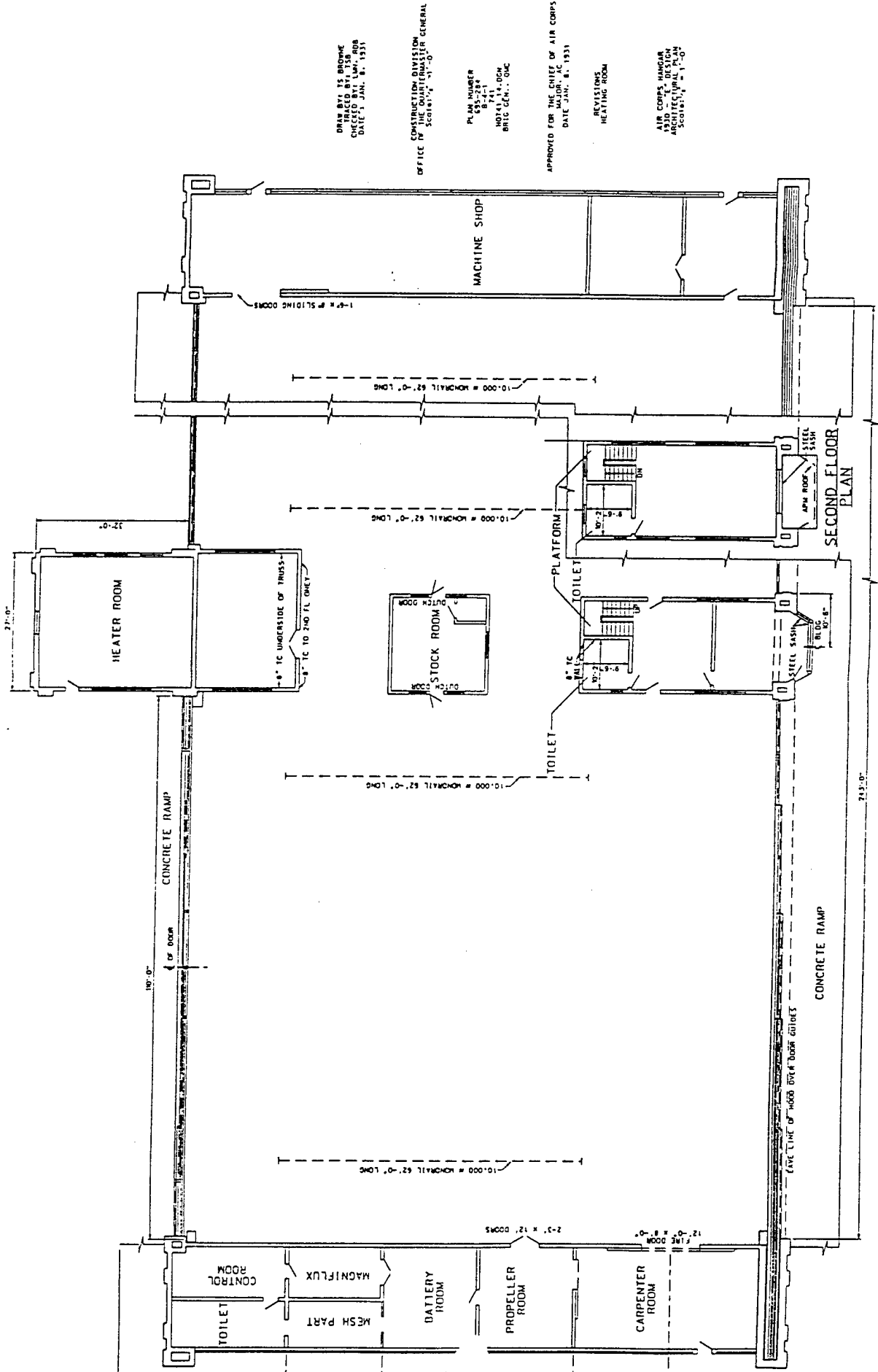

DRIVE BY: 15 BROWNE
 CHECKED BY: LAM, ROB
 DATE: 1 JAN. 8, 1931

CONSTRUCTION DIVISION
 OFFICE OF THE CHIEF OF AIR CORPS
 SCOTLAND, N.Y.

PLANNED BY
 8-2-1
 H0741-14-000
 BRIG GEN., OMC

APPROVED FOR THE CHIEF OF AIR CORPS
 DATE JAN. 8, 1931

REVISIONS
 HEATING ROOM

AIR CORPS HANGAR
 ARCHITECTURAL PLAN
 SCOTLAND, N.Y.

FIRST FLOOR PLAN
 100'-0" x 24'-0"

m0741_14.dgn

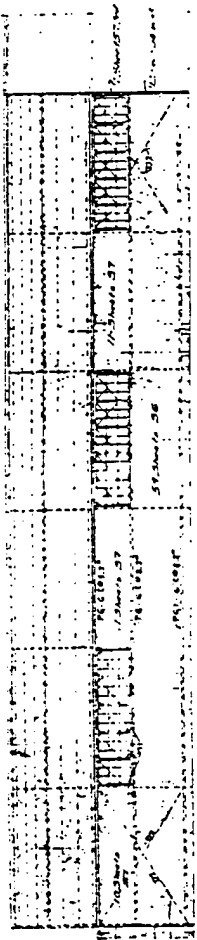

Side Elevation

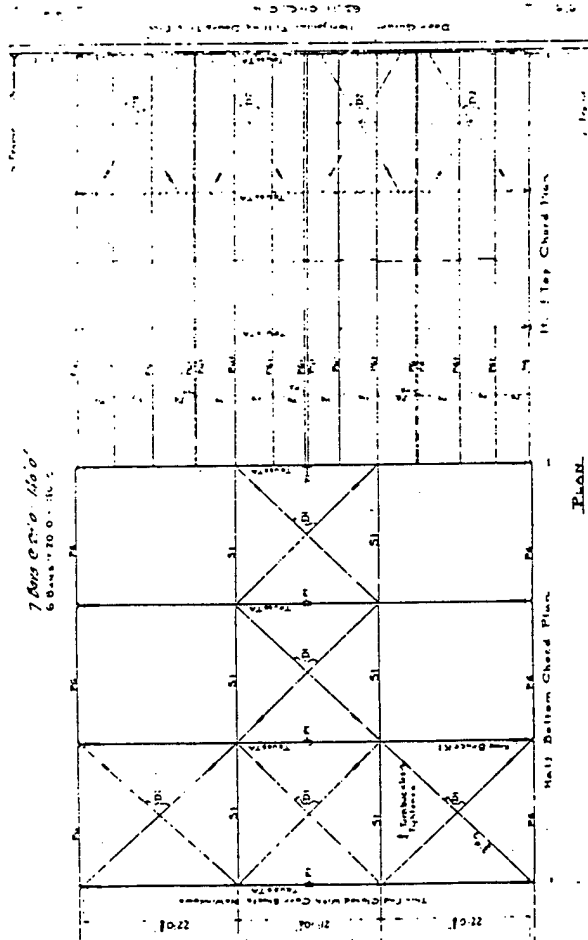

Plan

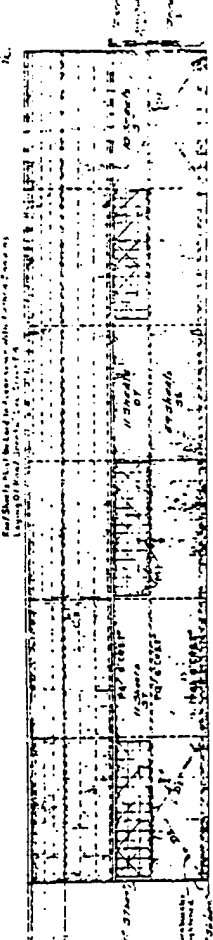

Side Elevation

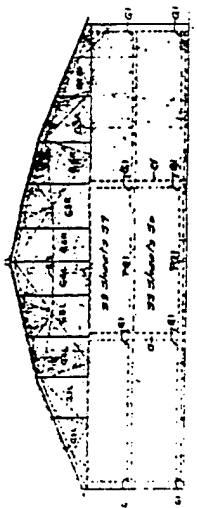

View to Clear End

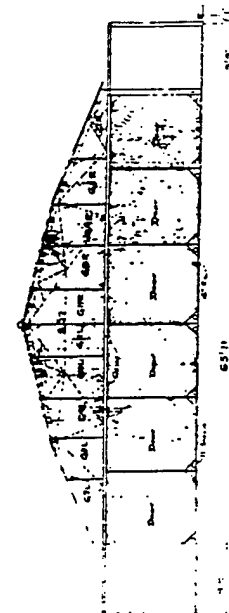

View to Rear End

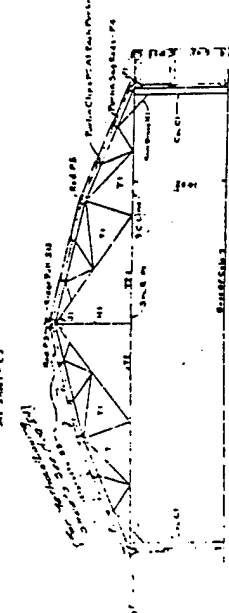

Carrel Section

FOR THE CHIEF OF AIR SERVICE
 APPROVED BY
 [Signature]
 [Date]
 APPROVED ALL STEEL RIFFLING HANGAR
 APPROVED BY
 [Signature]
 [Date]
 APPROVED BY
 [Signature]
 [Date]

NOTE: THIS DESIGN WAS PREPARED AND MATERIALS SPECIFIED BY THE AIR SERVICE. CONSTRUCTION BY CONTRACTOR SERVICE O.M.C. AND FOR ERECTION PURPOSES ONLY AND INVOLVE NO APPROVAL OF THE STRUCTURAL DESIGN.

NOTED BY
 [Signature]
 [Date]

Category: TRANSPORTATION

Type 10 b-1: Animal-Related: Stables and Stable Complexes

Description:

Stables were constructed to house horses or mules and were an important part of nineteenth- and early twentieth-century Army posts associated with the cavalry and artillery. Stables also were associated with installation or regional quartermaster logistical and supply activities. Stables typically were long, rectangular, gable-roofed structures, with doors at the end elevations and windows along the side elevations. Most surviving examples were built of brick or stone. The stables for different branches are located in distinct areas of the post. The quartermaster stables generally were one-and-a-half stories with the half story used as a hay loft; they typically display little architectural detailing. Cavalry and artillery stables were constructed generally as separate complexes consisting of stables, stable guard houses, and blacksmith shop. Artillery stable complexes also included gun sheds. Cavalry and artillery stables are characterized by monitor roofs and, at permanent installations, by a greater degree of architectural detailing than that found on other types of stables.

Evolution:

Quartermaster stables and corral for the animals used to transport provisions were standard components of nineteenth-century western posts. Corrals were large square enclosed areas to protect horses from attackers. Stables at the many temporary, frontier posts were utilitarian, long, rectangular buildings located apart from the parade ground, near the shop buildings. Quartermaster stables gradually disappeared when railroads became the primary means of transporting supplies to Army installations. Yet, isolated installations continued to rely on wagon suppliers until the advent of trucks and motorized transport, sometimes until the 1930s. The Quartermaster stables identified in this study have remained remarkably similar over time. The typical example of a Quartermaster stable is rectangular, one-and-one-half story building, with stalls on the ground floor and a storage area in the half story. Most installations had no more than a few Quartermaster stables.

During the nineteenth and early twentieth centuries, cavalry and artillery regiments required horses as the main support for their missions. At the small frontier posts of the mid-nineteenth century, cavalry horses were stabled directly behind the barracks. Unofficial Army regulations proposed in 1860 recommended enclosed stables with a central corridor lined with stalls.¹¹ At frontier posts, stables were arranged in blocks with open stalls facing each other, or they were arranged in rows. The quality of stables was a matter of concern to officers; one writer noted that:

¹¹ War Department, *Regulations Concerning Barracks and Quarters for the Army of the United States, 1860*, Washington, D.C. George W. Bowman, 1861.

“From the number of suggestions received from cavalry officers about stables, it would appear that there is room for Improvement in their construction . There seems to be a general opinion that we should have closed stables where the winters are severe, and open stables where they are not. That closed stables should have ridge ventilation, and should be better lighted than they generally are.”¹²

When the Army consolidated its troops at larger, permanent posts during the 1880s and 1890s, cavalry and artillery posts required larger stable complexes. The Quartermaster Department began to incorporate cavalry and artillery stables as part of the design and overall plan for new installations. At Ft. Riley, Kansas, for example, stables and guard houses became an integral part of the installation plan. The cavalry stables were located along the southern edge of the installation, arranged in an arc. The rectangular stables were closed entirely under a gable roof with a ventilation monitor along the ridge of the roof; the interior plan consisted of a central corridor lined with stalls. This basic form of permanent cavalry stable continued until World War I. Horses were among the most valuable property at the posts; consequently, stable guardhouses were a standard component of stable complexes. The guardhouses typically were simple, one-story buildings that matched the stables in construction materials and character.

Distinct veterinarian stables and support buildings were constructed after around 1900. The first veterinarian complex was constructed at Ft. Sheridan, Illinois.¹³ Veterinarian stables characteristically were T-shaped buildings with a large arched opening at the end elevation that provided cover for both horses and supply wagons. The interior plan was similar to other types of stables. Separate veterinarian facilities were constructed at Ft. Riley, Kansas, in 1902, and at Ft. D. A. Russell, in 1908.

Artillery stables were similar to cavalry stables. The major distinction was that some artillery stables were T-shaped and narrower than the stables for cavalry horses. Artillery stables also were built in complexes consisting of rows of stables with guardhouses between the stables. Artillery stable complexes had one additional building type, the gun shed, which was used to house artillery. At Ft. Riley, the gun sheds are one-story, narrow, rectangular, gable-roofed structures arranged in a widely spaced row across from the artillery stables.

Evidence of formally planned cavalry and artillery stable complexes remains extant at Ft. Riley, Kansas; Ft. Sheridan, Illinois; Ft. Sill, Oklahoma; Ft. Myer, Virginia; and, F.E. Warren AFB (formerly Ft. D. A. Russell), Wyoming. At Ft. Sill, Oklahoma, the shaped gable ends of the 1911 artillery stables reflected the influence of the Spanish Mission Revival architecture at the new artillery post.

The Army continued to construct cavalry and artillery stable complexes during the 1930s. The Army retained its horse cavalry until 1947 and its horse-drawn artillery until the eve of World

¹² Lieut.-Colonel Anderson, Army Posts, Barracks and Quarters, *Journal of the Military Service Institution of the United States* 11 (1 881): 446.

¹³ *National Register of Historic Places Registration Form, Fort Sheridan Historic District*, MSS, National Park Service, National Register of Historic Places, Washington, D.C., 1983.

War II. However, the number of stables decreased dramatically between World Wars I and II as motorized vehicles gradually replaced horses. Stable complexes constructed during the 1930s contained the same components as earlier stable complexes, including stable guard houses, gun sheds, and a veterinarian complex. The brick artillery stables at Ft. Bragg, North Carolina, consist of one-story rectangular stable sections with one-and-a-half story blocks at the end elevations. The stable guard houses resemble NCO cottages with porches. The gun sheds are one-story buildings with garage door openings along the side and a one-and-a-half story end block.

Although mechanization eventually replaced the horse, horses remained an integral part of Army culture. Officers were expected to practice their equestrian skills. Stables were included at military schools even during the 1930s. Even the Air Service Tactical School required 25 hours of instruction in stable management until 1923.

Association:

Stables and stable complexes are associated with a time when horses were essential to military operations. Horses were not only essential to cavalry and artillery units, but were used to move military supplies. Stables also are associated closely with frontier posts and western expansion. The evolution of the design of stable complexes is related to the development of installation planning, culminating in the post planning and beautification movements of the late nineteenth and early twentieth centuries. Stables can be major components of an installation or minor support buildings. A stable complex may possess significance for its association with significant historical themes or as a distinguishable architectural entity. Both stable complexes and isolated stables should be assessed for their potential as contributing buildings to an historic district, since stables were integral to the mission and operation of Army posts during most of the period preceding World War II.

Integrity:

Few military stables continue to serve as stables. Most stables have been converted to other uses, including storage, offices, resident support activities, garages, and hobby shops. To possess sufficient integrity to contribute to an historic district, stables and their associated support buildings should retain their original location and most of their setting, design, exterior materials, workmanship, and association. Exterior elements that often have been modified include location and size of window and door openings and the installation of new doors and windows. In cases of subsequent additions or renovations, the stables and associated buildings still may have integrity if they retain the majority of their character-defining features, including building shape, roof design, exterior materials, overall pattern of openings, and relationship to associated buildings within the installation plan.



1909 Cavalry Stable at (Fort D.A. Russell) F.E. Warren AFB, Wyoming



1909 Cavalry Stable at (Fort D.A. Russell) F.E. Warren AFB, Wyoming

CONSTRUCTION DIVISION OF THE ARMY CANTONMENT GROUNDS TYPICAL LAYOUT - REMOUNT STATION FOR 7500 ANIMALS

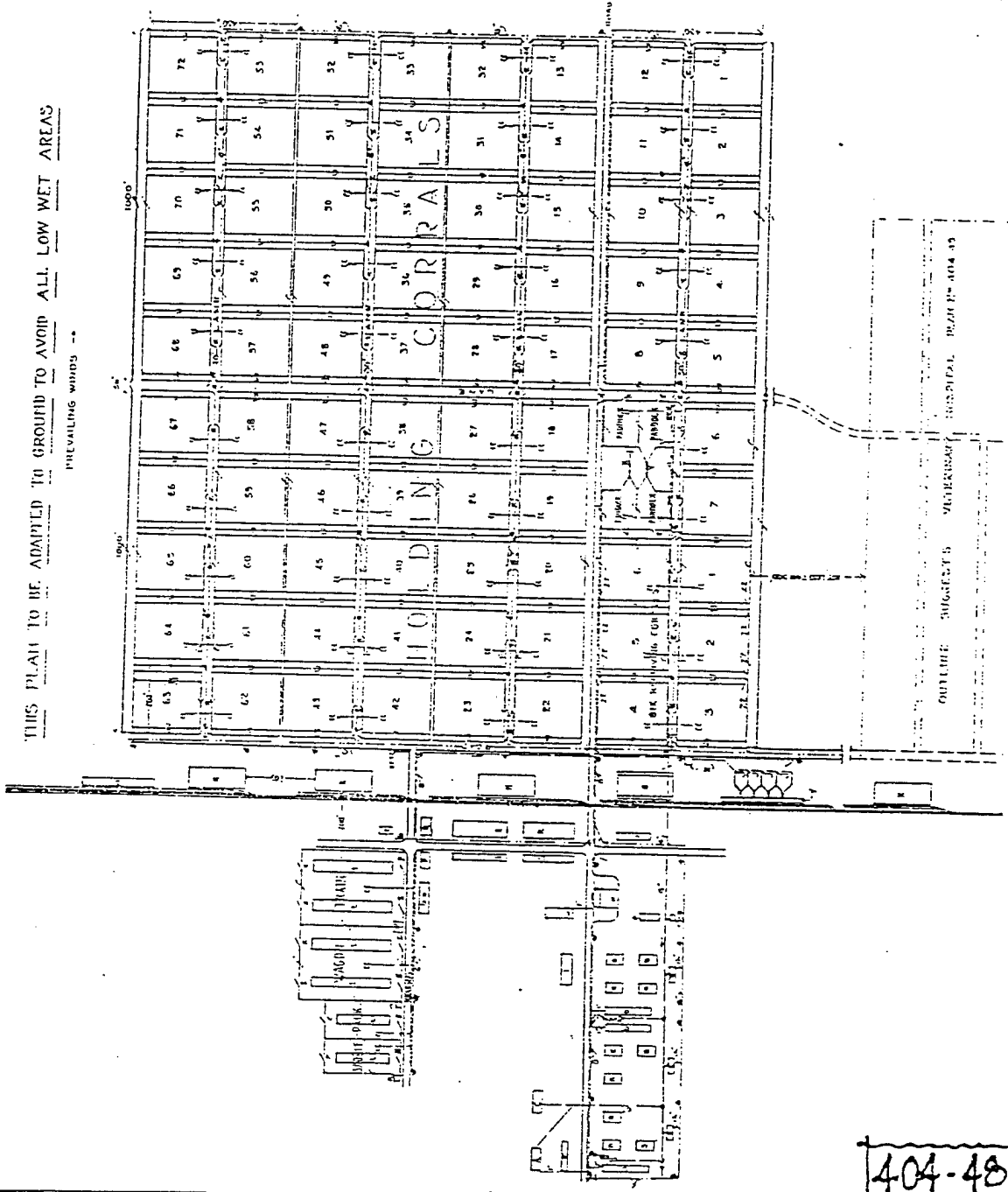

THIS PLAN TO BE ADAPTED TO GROUND TO AVOID ALL LOW WET AREAS

PREVAILING WINDS --

SCHEDULE OF BUILDINGS

NO.	DESCRIPTION	NO. OF BUILDINGS	AREA	VOLUME
1	OFFICES	1	1000	1000
2	OFFICES	1	1000	1000
3	OFFICES	1	1000	1000
4	OFFICES	1	1000	1000
5	OFFICES	1	1000	1000
6	OFFICES	1	1000	1000
7	OFFICES	1	1000	1000
8	OFFICES	1	1000	1000
9	OFFICES	1	1000	1000
10	OFFICES	1	1000	1000
11	OFFICES	1	1000	1000
12	OFFICES	1	1000	1000
13	OFFICES	1	1000	1000
14	OFFICES	1	1000	1000
15	OFFICES	1	1000	1000
16	OFFICES	1	1000	1000
17	OFFICES	1	1000	1000
18	OFFICES	1	1000	1000
19	OFFICES	1	1000	1000
20	OFFICES	1	1000	1000
21	OFFICES	1	1000	1000
22	OFFICES	1	1000	1000
23	OFFICES	1	1000	1000
24	OFFICES	1	1000	1000
25	OFFICES	1	1000	1000
26	OFFICES	1	1000	1000
27	OFFICES	1	1000	1000
28	OFFICES	1	1000	1000
29	OFFICES	1	1000	1000
30	OFFICES	1	1000	1000
31	OFFICES	1	1000	1000
32	OFFICES	1	1000	1000
33	OFFICES	1	1000	1000
34	OFFICES	1	1000	1000
35	OFFICES	1	1000	1000
36	OFFICES	1	1000	1000
37	OFFICES	1	1000	1000
38	OFFICES	1	1000	1000
39	OFFICES	1	1000	1000
40	OFFICES	1	1000	1000
41	OFFICES	1	1000	1000
42	OFFICES	1	1000	1000
43	OFFICES	1	1000	1000
44	OFFICES	1	1000	1000
45	OFFICES	1	1000	1000
46	OFFICES	1	1000	1000
47	OFFICES	1	1000	1000
48	OFFICES	1	1000	1000
49	OFFICES	1	1000	1000
50	OFFICES	1	1000	1000
51	OFFICES	1	1000	1000
52	OFFICES	1	1000	1000
53	OFFICES	1	1000	1000
54	OFFICES	1	1000	1000
55	OFFICES	1	1000	1000
56	OFFICES	1	1000	1000
57	OFFICES	1	1000	1000
58	OFFICES	1	1000	1000
59	OFFICES	1	1000	1000
60	OFFICES	1	1000	1000
61	OFFICES	1	1000	1000
62	OFFICES	1	1000	1000
63	OFFICES	1	1000	1000
64	OFFICES	1	1000	1000
65	OFFICES	1	1000	1000
66	OFFICES	1	1000	1000
67	OFFICES	1	1000	1000
68	OFFICES	1	1000	1000
69	OFFICES	1	1000	1000
70	OFFICES	1	1000	1000
71	OFFICES	1	1000	1000
72	OFFICES	1	1000	1000

LEGEND

- SERIES, SUPER, PROS.
- SERIES, MOUNTAIN
- GRASS, 100'
- BATH, OFFICERS
- WATER
- WINDMILL
- VALVE
- ROAD, 100'

SCALE 1"=100'

404-48

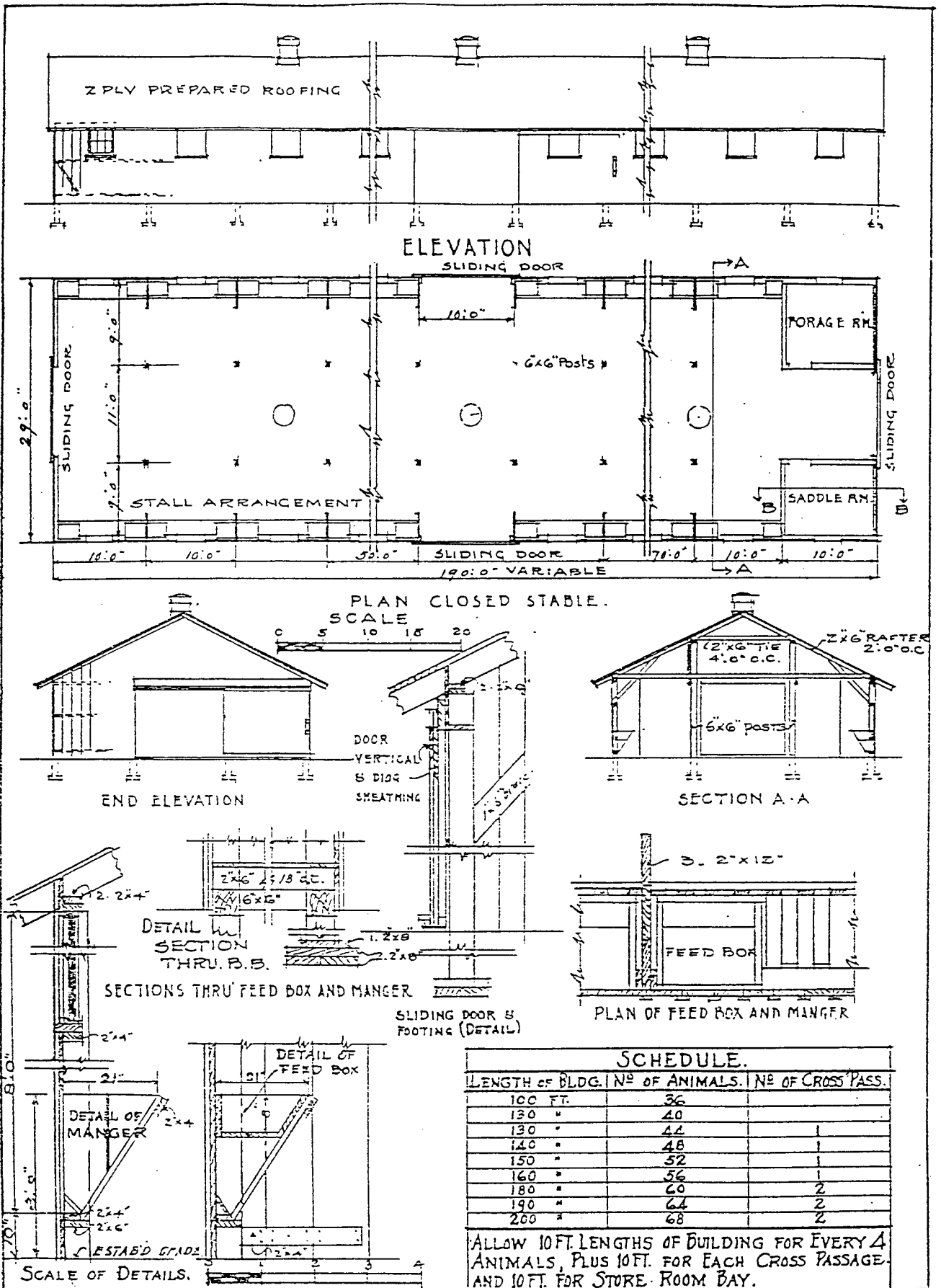

SCHEDULE.

LENGTH OF BLDG.	Nº OF ANIMALS.	Nº OF CROSS PASS.
100 FT.	36	
130 "	40	
130 "	44	
140 "	48	1
150 "	52	1
160 "	56	1
180 "	60	2
190 "	64	2
200 "	68	2

ALLOW 10 FT. LENGTHS OF BUILDING FOR EVERY 4 ANIMALS, PLUS 10 FT. FOR EACH CROSS PASSAGE AND 10 FT. FOR STORE ROOM BAY.

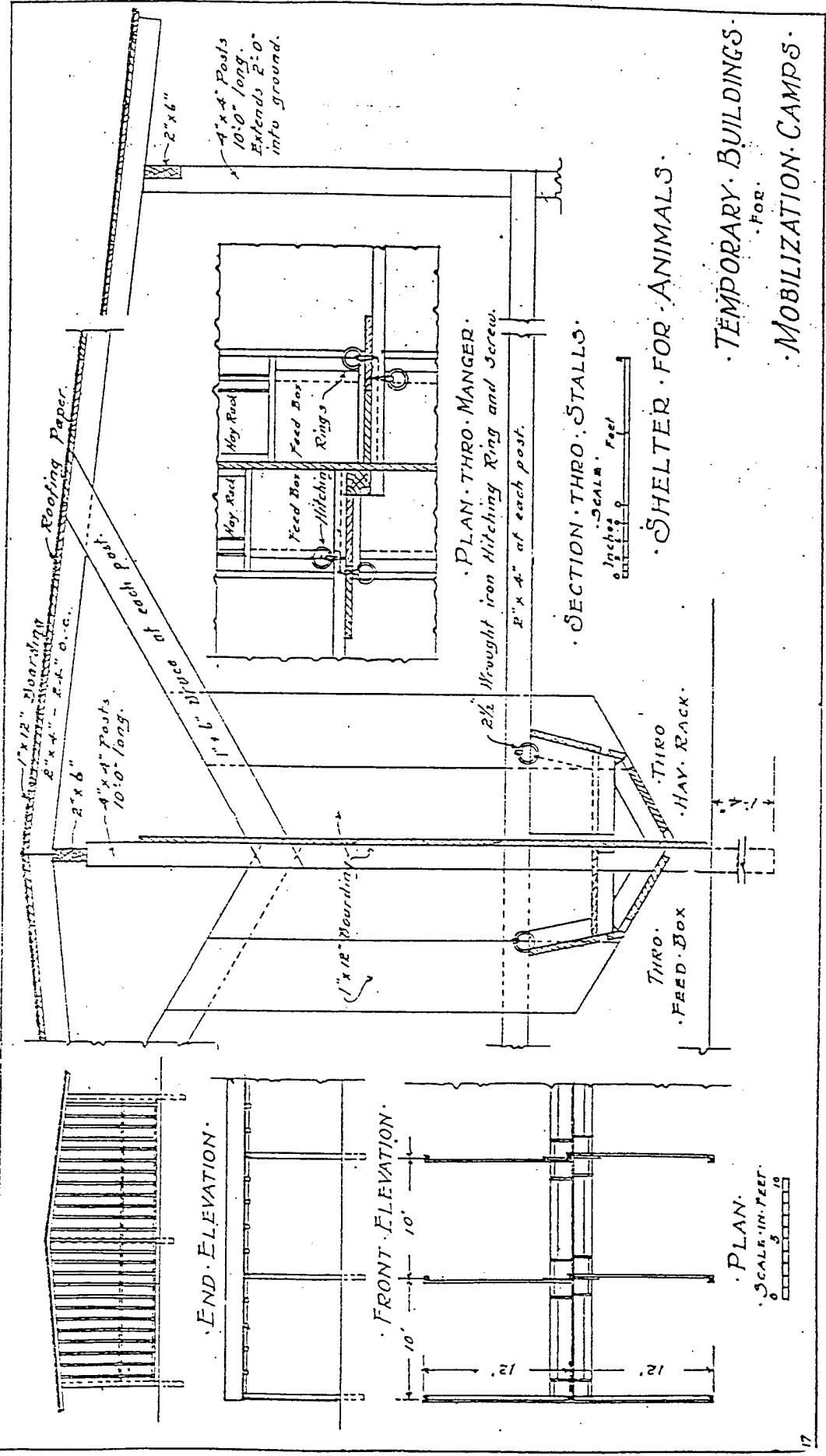

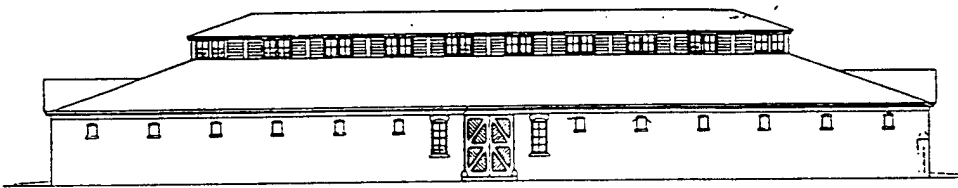

Side Elevation

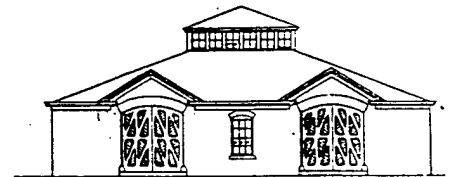

Front Elevation

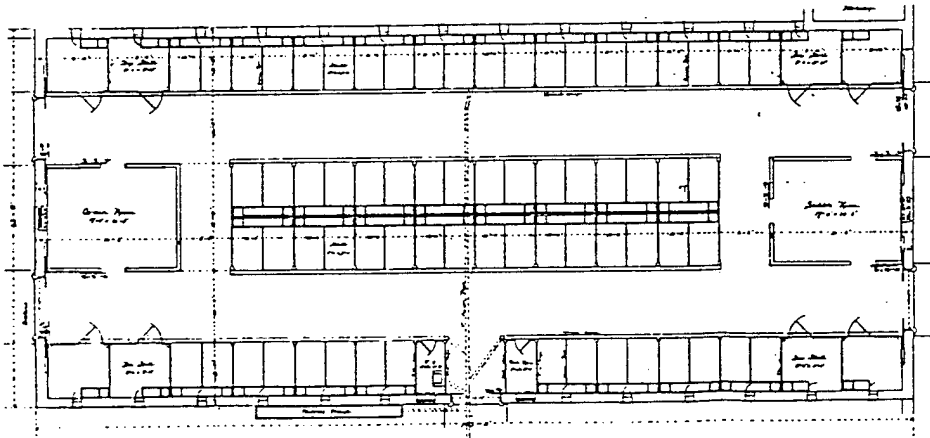

Ground Plan



Plan 1/4" = 1'

Cavalry Stables
 Fort Riley, Mo.
 Copy on 2d Hand.
 U.S. A. E. S. P.
 No. 10

Sheet 31
 U. S. A. E. S. P.

263 269 HANDED

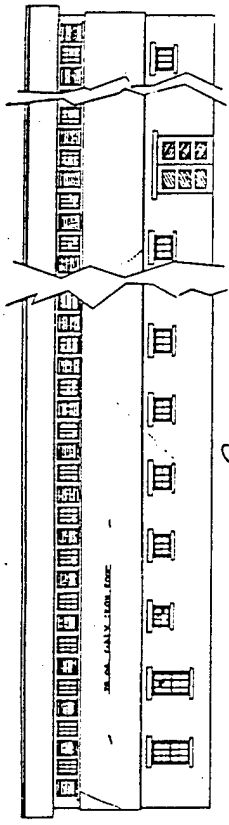

Schubert

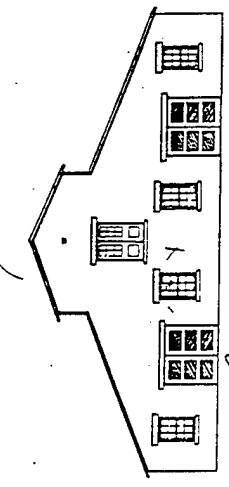

End ELEVATION

Schedule

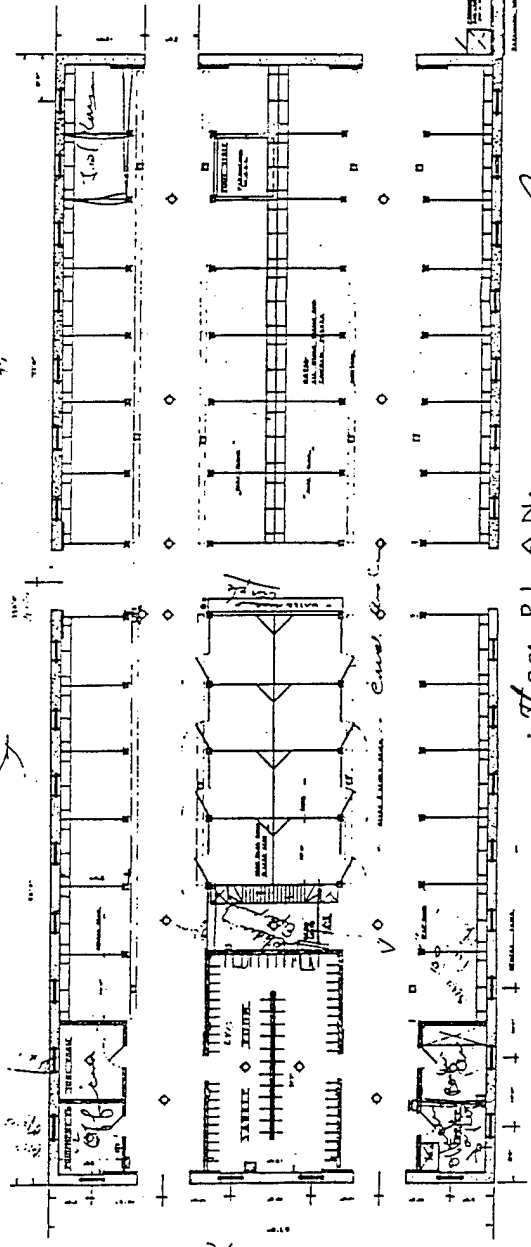

Floor PLAN

*State Terminal Co.
Typical Plan*

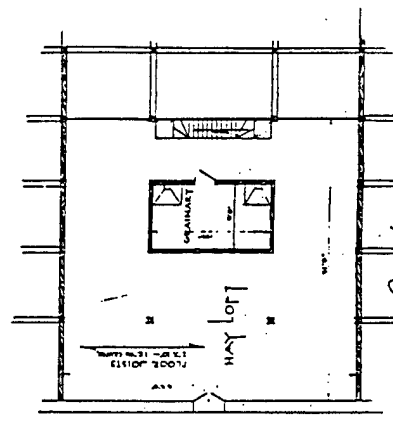

Loft PLAN

ONE	TWO	THREE	FOUR	FIVE	SIX	SEVEN	EIGHT	NINE	TEN
ONE	TWO	THREE	FOUR	FIVE	SIX	SEVEN	EIGHT	NINE	TEN
ONE	TWO	THREE	FOUR	FIVE	SIX	SEVEN	EIGHT	NINE	TEN
ONE	TWO	THREE	FOUR	FIVE	SIX	SEVEN	EIGHT	NINE	TEN

- WELL
- DRAIN
- CEILING OUTLET
- BEACON LIGHT
- WALL MOUNT
- TELEPHONE
- WALL SWITCH
- WATER TROUGH
- CONCRETE
- STONE
- CABINET
- SPINDLE

Legend

Battery Stables

Artillery Park, Two Rills, Stone.

Designed by Maj. J. B. Mitchell,
Capt. Gen. I. Park, 1862, U.S.A.
Scale, 1/4" = 1'

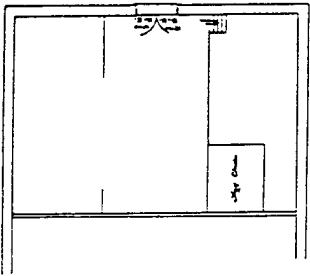

Plan of Low Entrance.

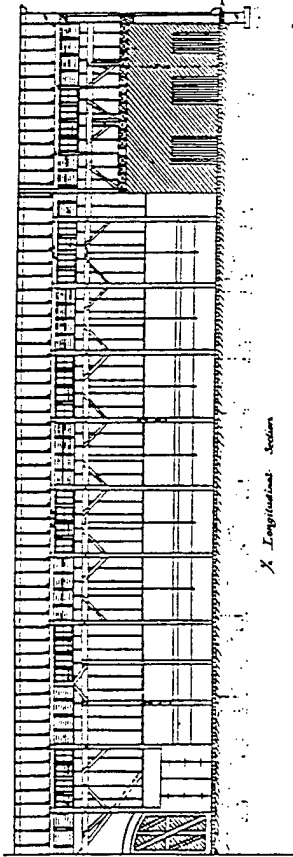

X Longitudinal Section.

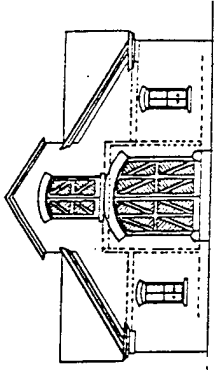

End Elevation.

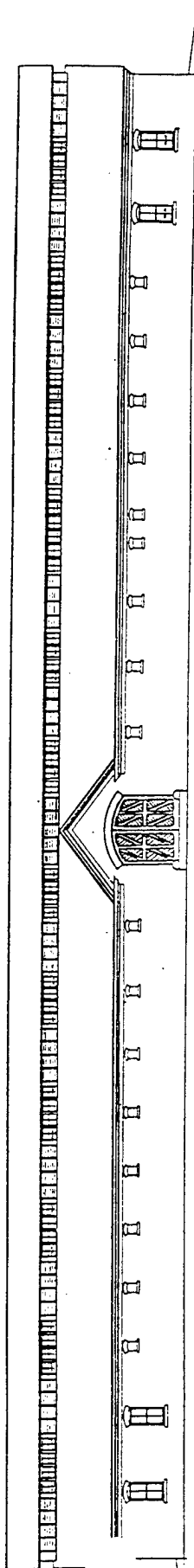

Side Elevation.

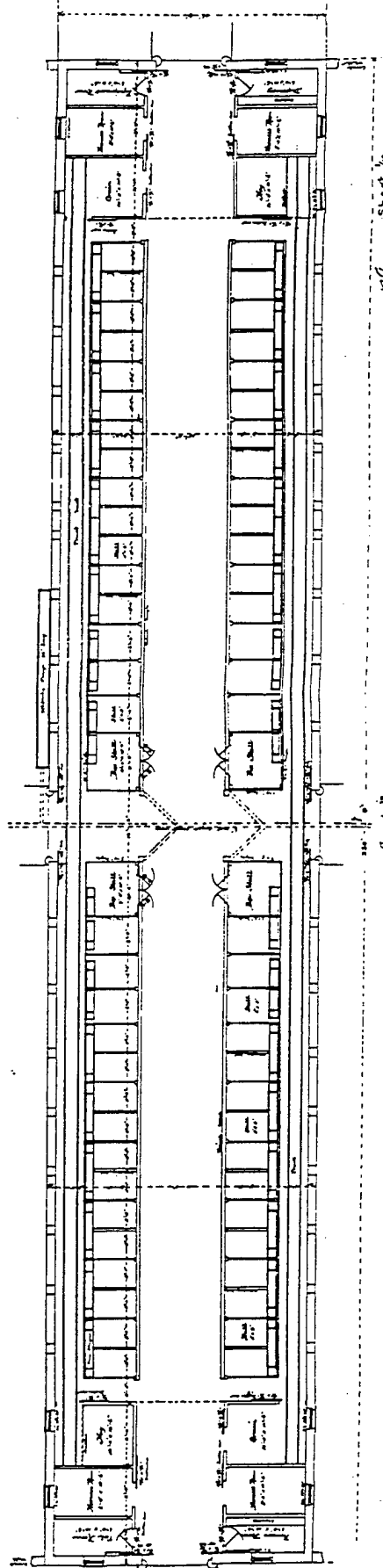

Ground Plan.

78
Sheet No.
U. File A11-19

1887 18822.M.C.T.

NO 362.01.c11

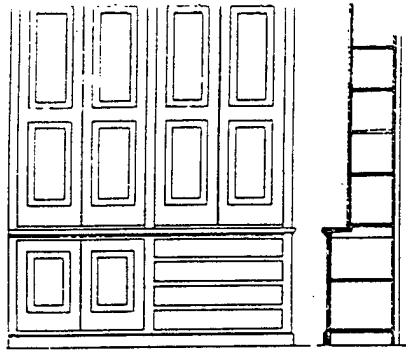

ELEVATION MEDICINE CLOSET
Scale 1/2" = 1'-0"

SECTION

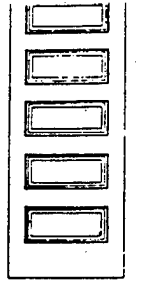

ELEVATION OF DOOR
Scale 1/2" = 1'-0"

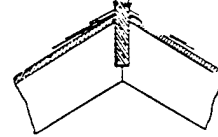

SECTION OF ROOF
Scale 1/2" = 1'-0"

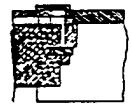

HORIZONTAL SECTION OF DOOR FRAME



SECTION OF DOOR FRAME
Scale 1/2" = 1'-0"

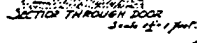

SECTION THROUGH DOOR
Scale 1/2" = 1'-0"

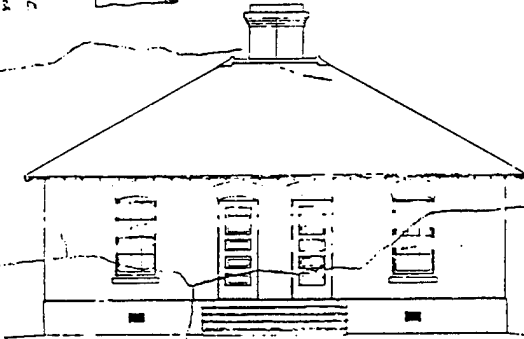
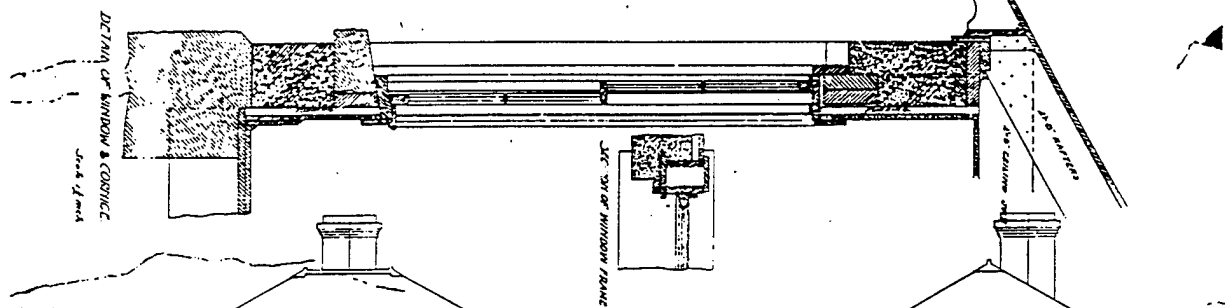

FRONT ELEVATION
Scale 1/2" = 1'-0"

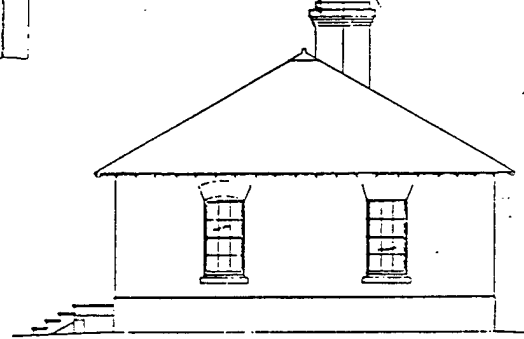

SIDE ELEVATION
Scale 1/2" = 1'-0"

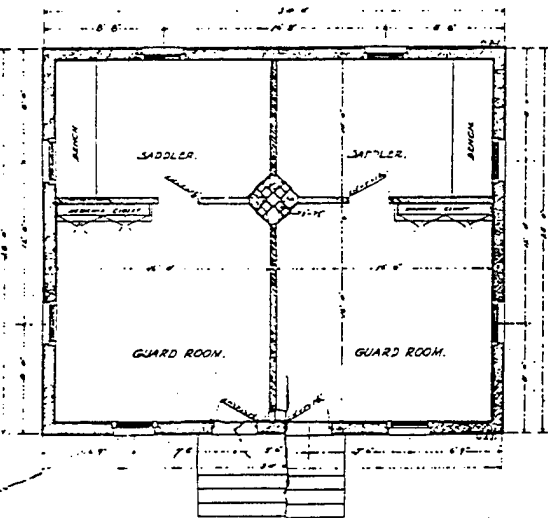

FIRST FLOOR PLAN
Scale 1/2" = 1'-0"

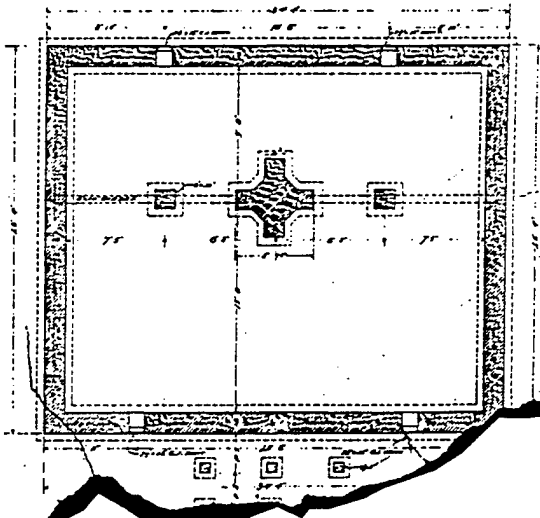

STABLE GUARD HOUSE
39 C
94 60
100 00

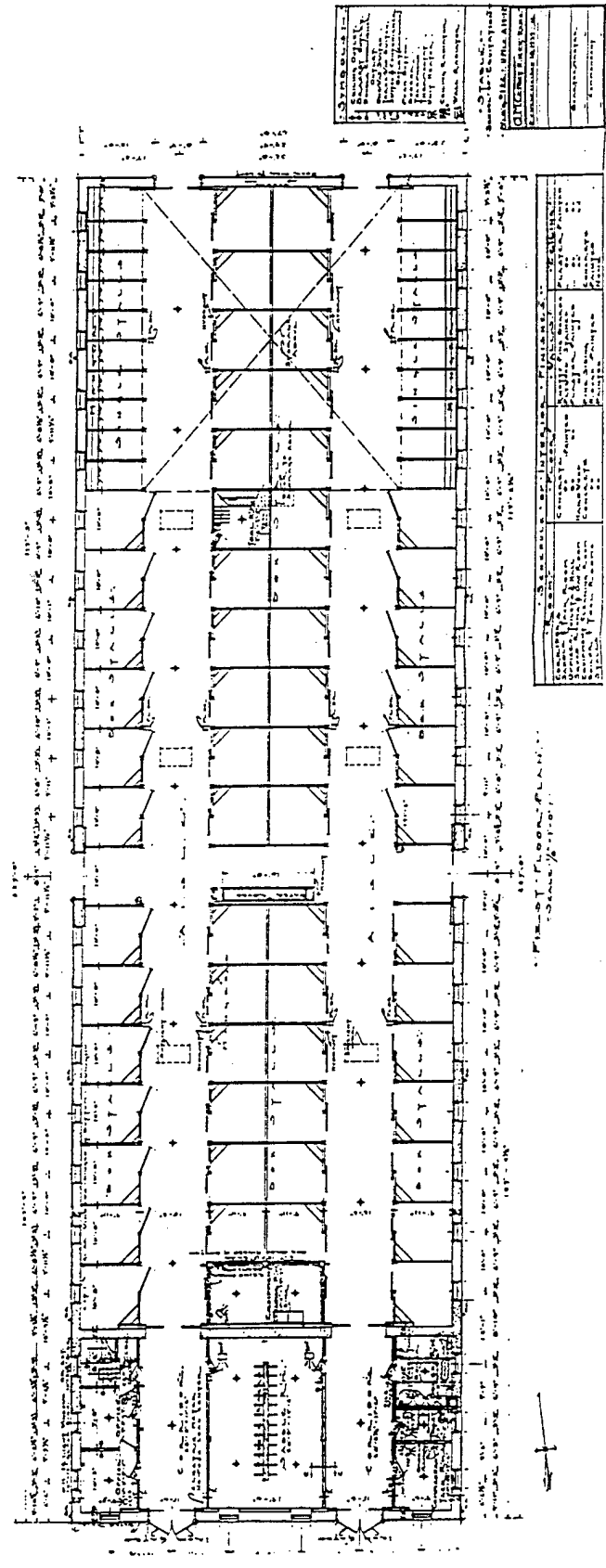
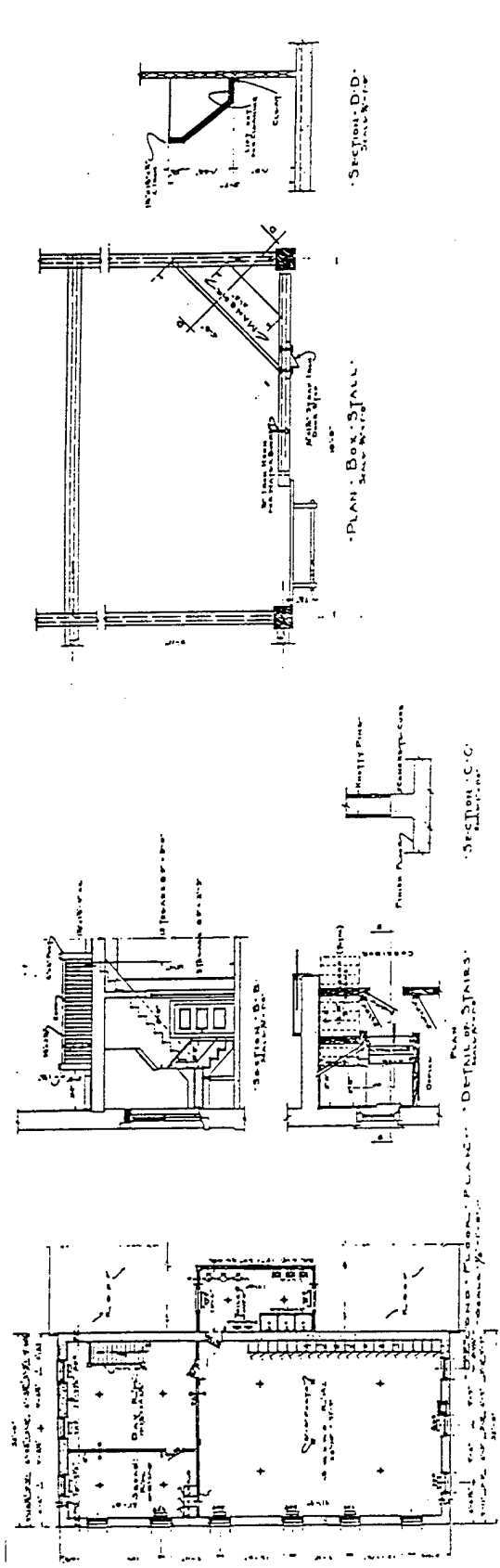

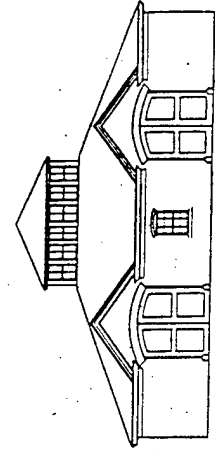

FRONT ELEVATION
SCALE 1/4" EQUALS 1'-0"

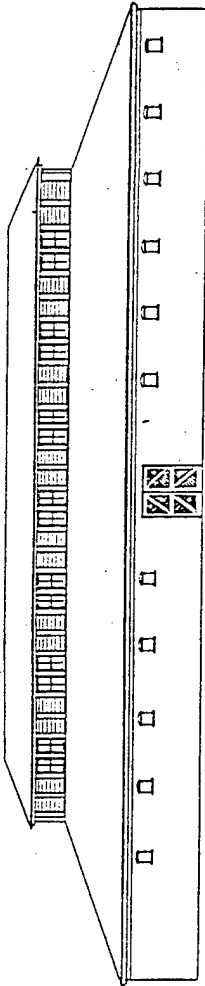

SIDE ELEVATION
SCALE 1/8" EQUALS 1'-0"

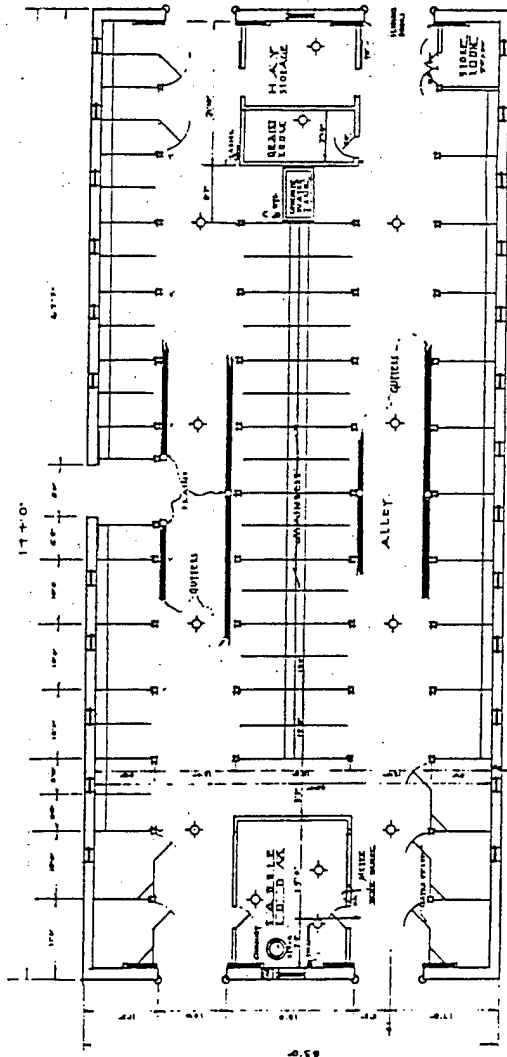

GROUND PLAN
SCALE 1/8" EQUALS 1'-0"



ENGINEER	SCALE	REV.
DATE	BY	NO.
PROJECT	DESCRIPTION	
LOCATION	DATE	
DESIGNER		
CHECKER		
APPROVER		

PROJ. 277-01.cit

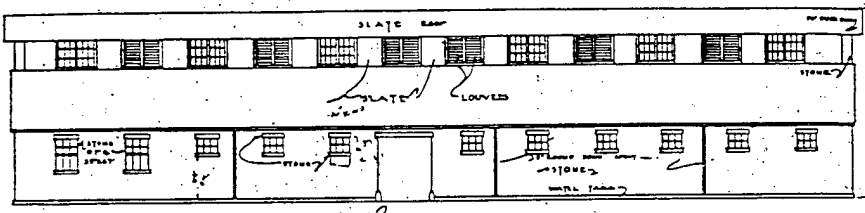

RIGHT SIDE ELEVATION

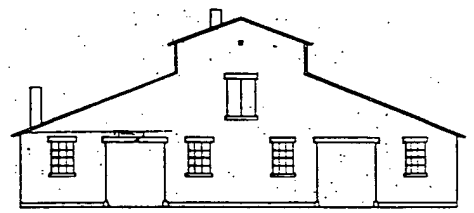

FRONT SIDE ELEVATION

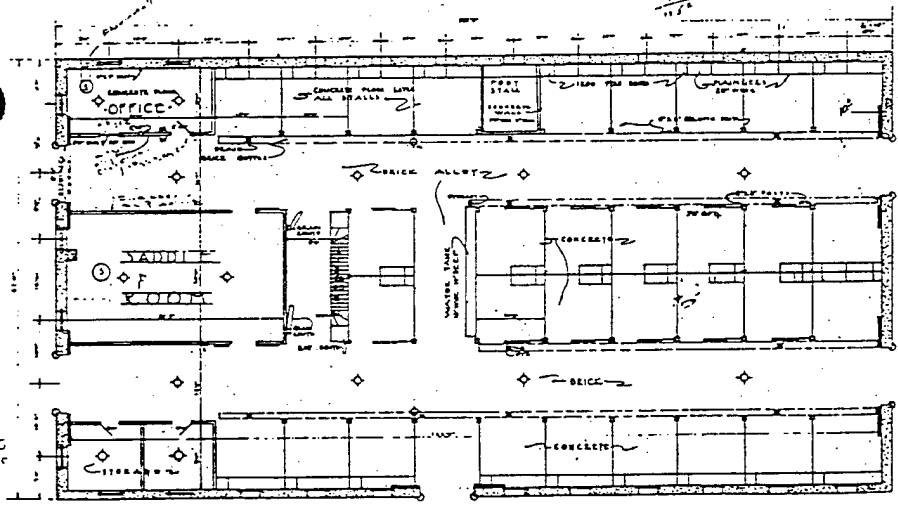

FLOOR PLAN
 SCALE 1/8" = 1'-0"
 DRAWING BY W. C. CO.

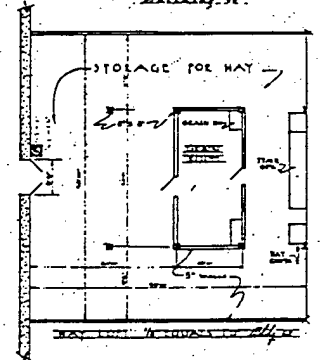

- LEGEND
- ◆ BRICK ALLOYS
 - ◆ CONCRETE
 - ◆ WIND BREAK
 - ◆ STORAGE FOR HAY
 - ◆ BEAM
 - ◆ WALL
 - ◆ DOOR
 - ◆ WINDOW
 - ◆ FLOOR
 - ◆ CEILING
 - ◆ ROOF
 - ◆ CHIMNEY

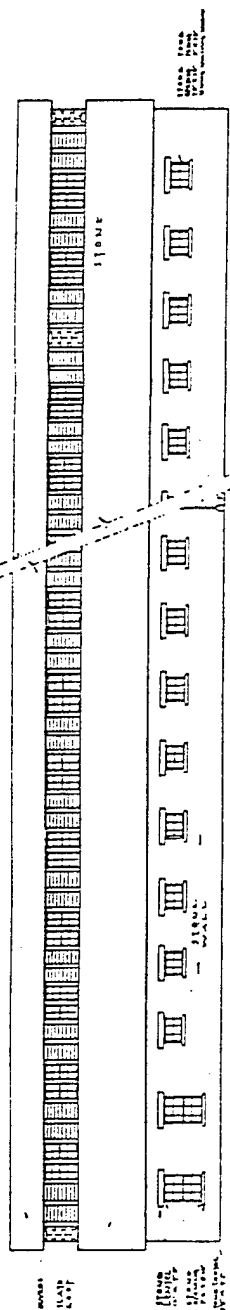

RIGHT Side ELEVATION
SCALE 1/8" = 1'-0"

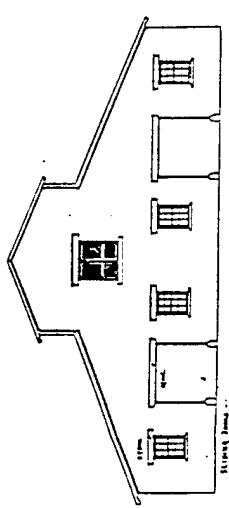

FRONT Side ELEVATION
SCALE 1/8" = 1'-0"

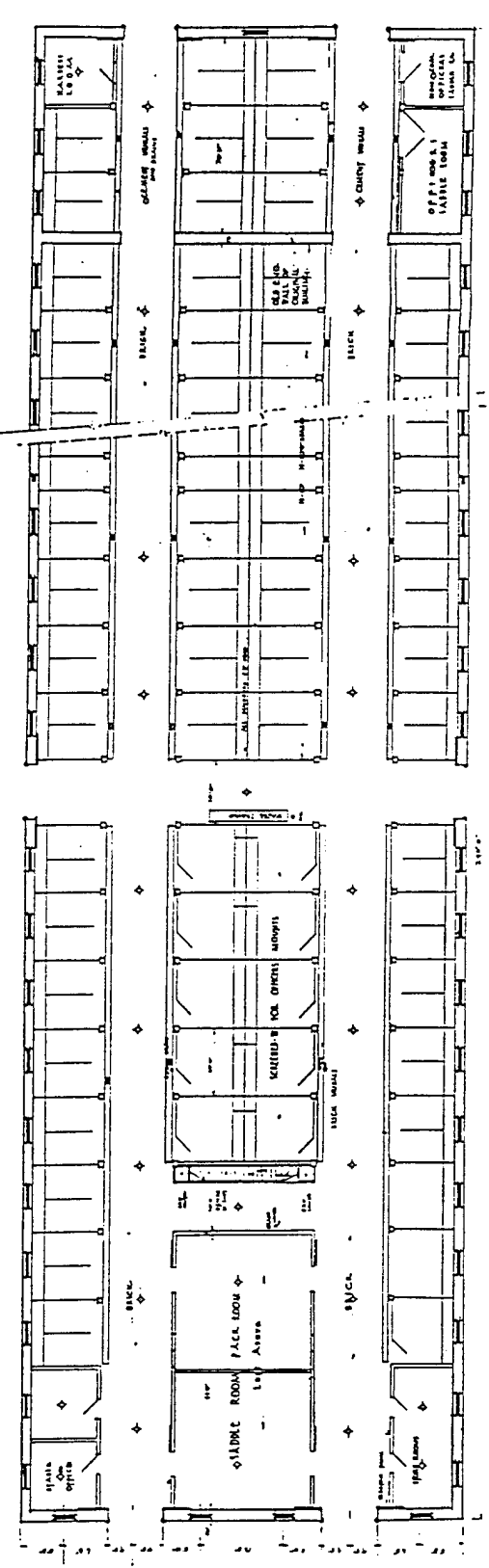

FLOOR PLAN
BUILDING No. 110 SCALE 1/8" = 1'-0"

GENERAL CONTRACTOR	...
ARCHITECT	...
ENGINEER	...
ELECTRICIAN	...
MECHANICAL	...

Category: TRANSPORTATION

Type 10 c-1: Vehicle-Related: Gas Stations

Description:

Gas stations first were constructed at military installations during the 1930s. The gas stations resembled small, civilian service stations of the same era. The typical gas station consisted of a small, one-story building with several gasoline pumps in front of the building. In some examples, a roof extended from the building over the pumps. Gas stations often were designed to match the prevailing architectural style of the installation, such as the Spanish Colonial Revival or the Georgian Colonial Revival. Gas stations constructed during the 1930s sometimes display the elements of the streamlined Moderne architectural style. Installations typically had only one gas station, usually located in a convenient, yet unobtrusive site.

Evolution:

Gas stations were constructed as minor support facilities during the wave of new construction of the late 1920s and 1930s when the Army modernized many of its posts and airfields. Gas stations of the inter-war period retain the same general appearance and do not display any major evolution in design. Most surviving examples of the early gas stations were constructed during the late 1930s; earlier examples may have been demolished to make way for more modern facilities. The small gas stations generally had only a few pumps and were designed to complement the design of the other buildings of the cantonment, particularly at installations built during the inter-war period. Post World War II gas stations are much larger than the pre-war facilities.

Association:

Gas stations are associated with the development of automobiles as a major mode of transportation. They were constructed at military installations during the inter-war period, when the military began to provide many of the same services found in cities to installation residents. Pre-1940 gas stations are typically found at military installations with large resident populations. Gas stations are minor building types that do not possess individual historic significance. However, they can be contributing elements to an historic district if the design of the gas station reflects the overall architectural character of the individual installation.

Integrity:

To possess integrity, gas stations should retain their location and most of their setting, design, workmanship, and materials from their periods of construction. Most gas stations constructed before 1940 are no longer used as gas stations, or have been altered so that their original design is unrecognizable. Where subsequent additions or renovations have occurred, the building still may have integrity if it retains the majority of its character-defining features, such as the basic shape of the building, projecting roof bay, exterior materials, pattern of openings, and design features that define its original architectural expression, such as revival or Moderne stylistic references.

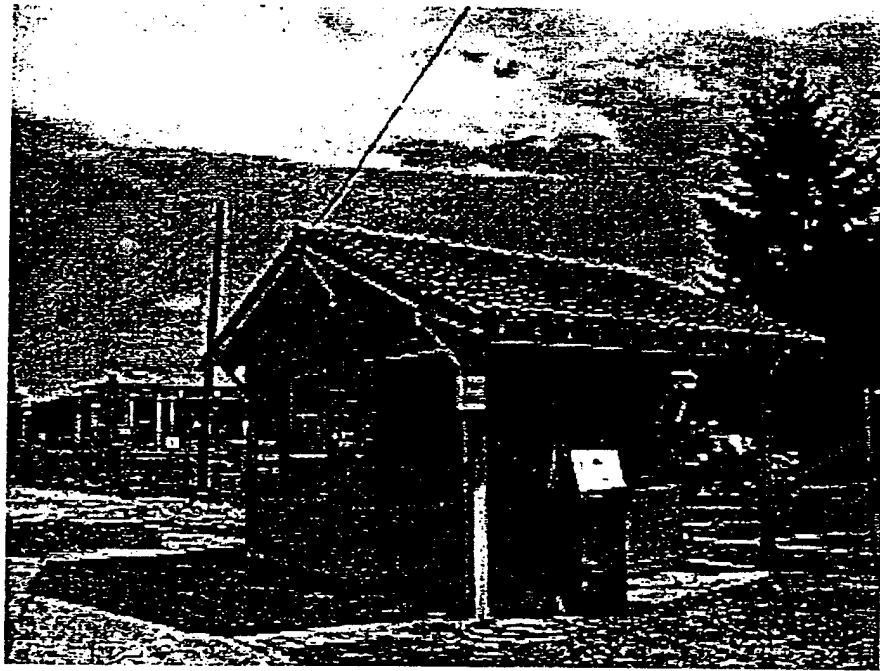

1939 Gasoline Station at Fort Lewis, WA

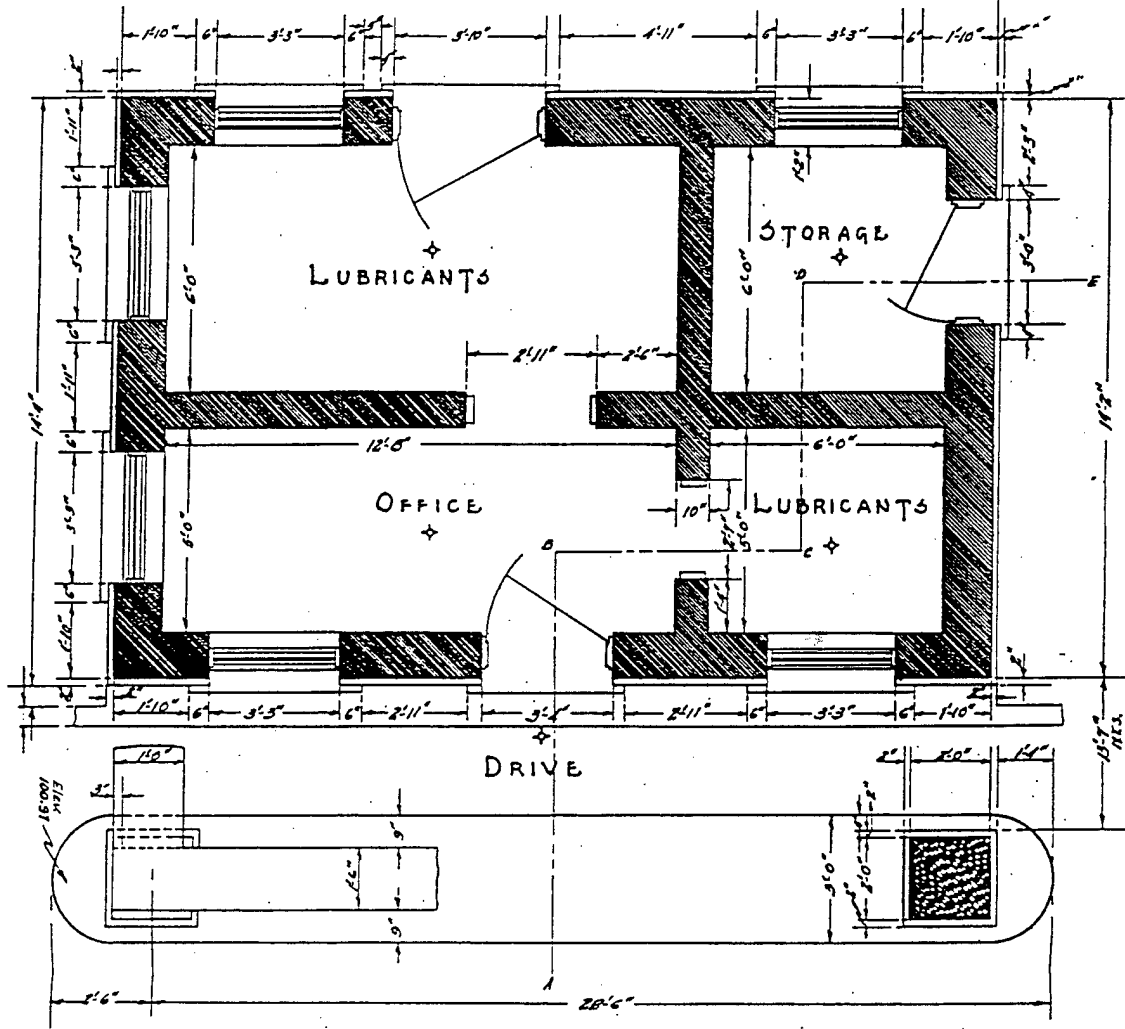

PLAN
SCALE 3/8" = 1'-0"

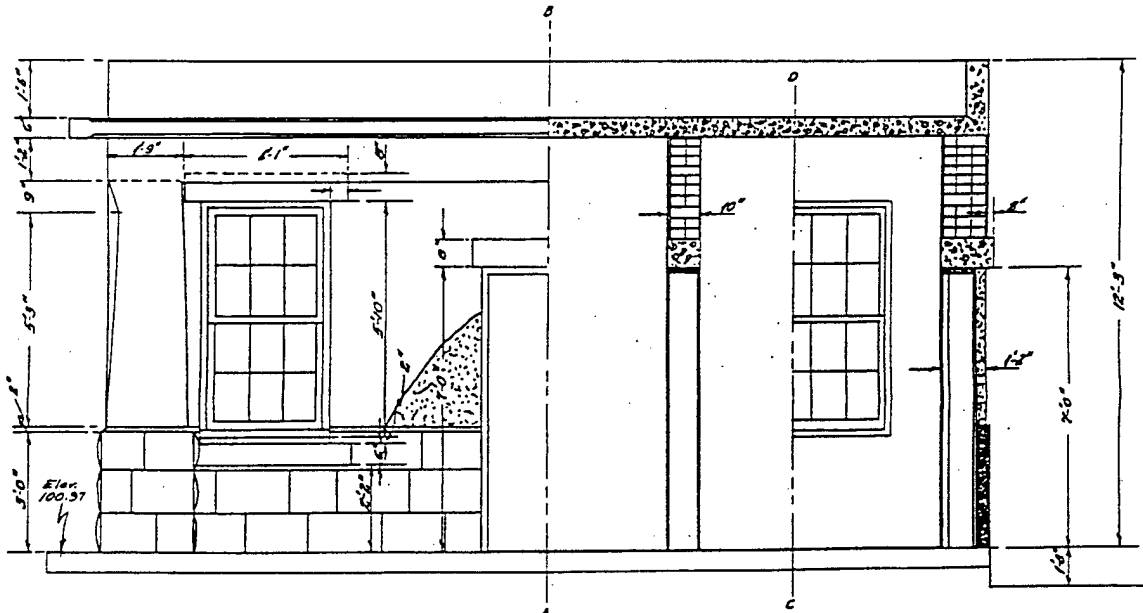

FRONT ELEV.
SCALE: 3/8" = 1'-0"

3 5 4

Q.M. GAS STATION - BLDG. 217
MAY 1932
U File AS-21
110354-01.CIT

Category: TRANSPORTATION

Type 10 c-2: Vehicle-Related: Motor Pools

Description:

The military, particularly the Army, began to construct facilities for motorized vehicles during the early twentieth century, when motorized vehicles began to replace trains and horses. Two types of motorized vehicle facilities were built: (1) motor pools to service and repair motorized vehicles that were used for logistical support and supply; and (2) separate facilities for tactical motorized vehicles. Garage and repair facilities were one-story, rectangular, masonry buildings with wide bands of industrial sash windows and parapeted gable ends; they resembled smaller versions of early 1930s gabled hangars. In some cases, larger motor pool facilities were constructed by joining several units of the basic building form. Motor pool facilities for tactical vehicles were larger than general motor pool facilities and typically consisted of buildings with one-story central portions flanked by block ends. Garage door bays lined the long sides of the center portion of the buildings. Motor pool facilities generally were located apart from the main cantonment area in a secondary service area.

Evolution:

The Army first used motorized vehicles in 1899; however, motorized transport did not prove itself until Pershing's expedition into Mexico in 1916 against Pancho Villa. Within three months of the expedition's start, the Army had 588 trucks, 57 motor tanks, 10 motor machine shop trucks, 6 wreckers, 75 automobiles, and 61 motorcycles.¹⁴

The Quartermaster Corps began to construct distinct motor pool areas, in the same way that earlier quartermasters had designed separate stable complexes. Motor pools of garages, storage facilities, and repair shops were located in a complex apart from the living and administrative areas of the post. The Quartermaster Corps may have based the designs for early motor pool buildings on stable designs; some early motor pool buildings have the monitor roof and shaped gable ends of some stable designs.

The typical motorized vehicle garage appears to have evolved from nineteenth-century vehicle storage sheds and gun sheds. Between the 1890s and 1917, the Quartermaster issued a series of standardized plans for sheds to store wagons and field artillery pieces. The typical vehicle shed was a horizontal, one-story building with wide, paired doors along the side elevation. Eventually, steel rolling doors on overhead tracks replaced the paired doors.¹⁵

Maintenance and repair shops for motorized vehicles generally were brick utilitarian structures with industrial sash windows. Most were constructed as part of the wave of new post construction and improvement during the 1930s. The Quartermaster Corps developed shop

¹⁴ Norman M. Cary, *The Use of the Motor Vehicle in the United States Army, 1899-1939*, Ph.D. diss., University of Georgia, 1980, 95-105.

¹⁵ NARA, Cartographic Branch, RG 77, Standard Plans of Army Post Buildings, 1891 - 1918, Plans 335, 396.

buildings as multiple-use building types. The same basic building design was constructed as utility buildings, general maintenance and repair shops, Army Air Corps shops, and general storehouse functions, in addition to its construction as maintenance and repair garages.

Specialized repair and maintenance facilities were developed to service tactical motorized vehicles, such as the early tanks developed for the mechanized cavalry. These facilities, which resembled the artillery stables also constructed during the 1930s, consisted of masonry, one-story, rectangular buildings flanked by blocks at the end elevations and with garage bay doors lining the side elevations. An important feature that distinguishes this building type from stables are the large expanses of industrial windows that provided interior light to aid repair work.

Some arsenals have vehicle repair shops that vary from the typical pattern. The technical branches often developed their own building plans instead of relying on Quartermaster plans. For example, the vehicle repair shop at Picatinny Arsenal, New Jersey, is a two-story, concrete structure with industrial, steel-sash windows; it resembles industrial designs for automotive shops and factories of the 1920s and 1930s.

Association:

Motor pools are associated with the adoption of mechanized vehicles for logistical support and as a tactical weapon during the inter-war period. These facilities are related to the themes of technology and transportation. Motorized vehicle facilities generally are utilitarian structures located in the support areas of an installation. They generally do not possess individual historic significance, but may be contributing elements to an historic district and can reflect, in a utilitarian fashion, the overall architectural character of an installation.

Integrity:

To possess integrity, motorized vehicle facilities should retain their location and most of their design, materials, setting, workmanship, and association from the period of significance of the historic district. Motor pool facilities often continue to serve as maintenance, repair, and storage facilities for military vehicles, or, at some installations, have been converted into storage or other utility shops. The size and location of openings may have changed; doors and windows often have been replaced. Where subsequent additions or renovations have occurred, the building may have integrity if it retains the majority of its character-defining features, including exterior construction materials, garage openings, metal sash windows, and relationship to associated buildings within the installation plan.

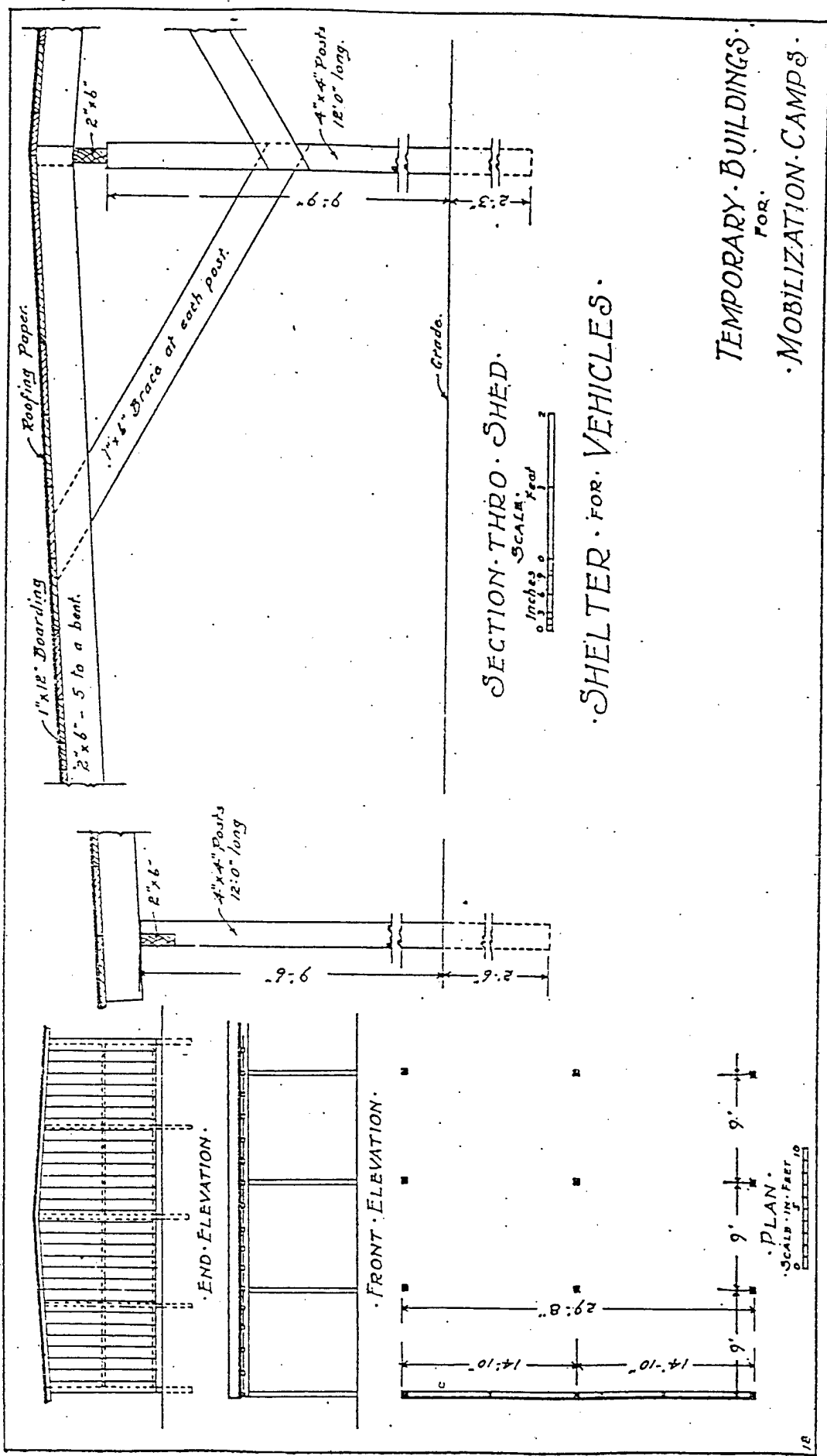

TEMPORARY BUILDINGS
FOR
MOBILIZATION CAMPS

SECTION THRO SHED

SHELTER FOR VEHICLES

SCALE
1/8" = 1'-0"

PLAN

SCALE 1/8" = 1'-0"

END ELEVATION

FRONT ELEVATION

Roofing Paper

1" x 12" Boarding

2" x 6" - 5 to a bent.

1/2" x 6" brace at each post.

4" x 4" Posts
12'-0" long.

6:6

Grade

4" x 4" Posts
12'-0" long.

2" x 6"

9:6

2:6

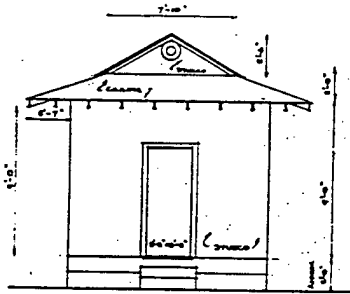

FRONT ELEVATION
SCALE 1/4"=1'-0"

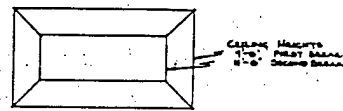

CEILING PLAN
SCALE 1/4"=1'-0"

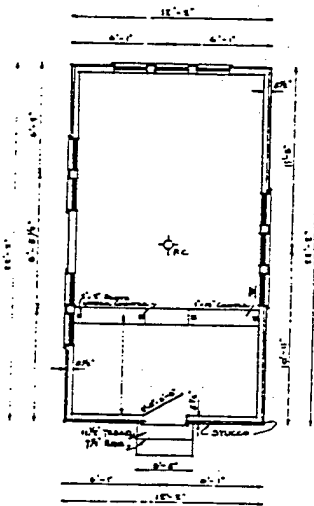

FLOOR PLAN
SCALE 1/4"=1'-0"

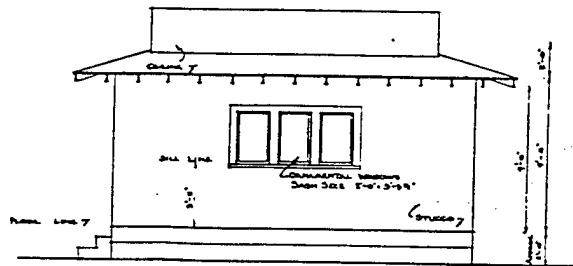

SIDE ELEVATION
SCALE 1/4"=1'-0"

DISPATCHER'S OFFICE
MOTOR TRANSPORT
GARAGE

BLDG # 154-A	UTILE A 154
PLANNING SECTION	
OFFICE OF THE QUARTERMASTER	
DESIGNED BY	JULY, 1934
FOR	ENGINEER
MADE BY	QUARTERMASTER
BY	COMMANDANT

MIDDLEBURY

333 882 NO 333_01.cit

Category: TRANSPORTATION

Type 10 d: Railroad-Related

Description:

The Army has been associated with planning and use of railroad facilities since their development in this country. A vital part of orchestrating the Army's logistics, the railroads have played an essential part in preparing to fight the nation's wars in the late nineteenth- and early twentieth centuries. Railroad facilities are still found at present day installations. Often disused, these facilities retain their historic significance and should be evaluated within the period of their historic design and use. An important consideration is the role railroads played in the development of circulation patterns and how those patterns are still used. Individual properties include spur lines, locomotive sheds, roundhouses, terminals, bridges and trestles.

Evolution:

The U.S. Army Corps of Engineers, as early as 1828, added surveys for railroads to their role mandated by the General Survey Act, passed by Congress in 1824. This act authorized the President "to cause the necessary surveys, plans, and estimates, to be made of the routes of such Roads and Canals as he may deem of national importance..." By the late 1830s, Congress felt federal assistance to railroads had gone far enough and the Corps went on to other work.¹

In the 1850s, the Army conducted surveys for transcontinental railroad routes, culminating in "the first four railroad lines after the Civil War."² Once established, the railroads and its workers profited from protection afforded by nearby Army posts. The Army benefited from cheap transportation that moved troops and supplies faster than wagons or barges. An increasingly complex Union Army evolved to fight the Civil War which required the ability to move large numbers of troops, supplies and equipment. The railroads furnished industry with raw materials and took finished products to depots. By 1862, the War Department was committed to using the railroads.

After the Civil War, the Army was again faced with high freight costs of supplying posts scattered across the American west. As the railroads extended their routes and developed their infrastructure, the Army brought together its small posts and started building permanent posts closer to the railroads. This logistical challenge was intensified during the Spanish American War when Army supplies bound for Cuba and shipped by railroad to Tampa flooded the port's capacity and "filled the sidings from Tampa to Columbia, South Carolina"³

In the later parts of the nineteenth- and the first decades of the twentieth centuries, the Army's needs increased yet again for reliable, low cost transportation. In World War I, the Army's size grew to over four million men. The Army's responsibilities also acquired an international

dimension: great numbers of troops, supplies, equipment and materials had to be moved about the country to ports of embarkation. Industry also needed access to railroad facilities to transport raw materials and finished goods for the Army and the Allies needs. Adding to the complexity, the country's requirements for select civilian shipping also had to be met.

Sites for permanent cantonments were selected in part because of accessibility to railroad lines. Where they were not immediately available, spur lines were built with the cantonments. Within these military settlements were railroad lines to move men, animals, guns, food, clothing and anything else the Army might need to ports of embarkation. Warehouses were built on either side of the spur lines for efficient loading and unloading, coal trestles were built to dump supplies of coal in a central location, hospitals had their own railroad spur lines for patients, the railroad spurs even extended to the stables and corrals of the cantonments. As a form of transportation, the railroads were considerably more advanced than wagons, and were developed in the brief span of years before the national highway system spread across the nation. During their time they were the leading edge of transportation technology.

Association:

The U.S. Army has contributed, with its sister services, to the development of America's railroad transportation system. The Army has also benefited from this association with lower transportation costs, the tactical ability to respond quickly to emergencies and use the railroads to move large quantities of troops and equipment at short notice. Development of the railroads was made possible, in part, by U.S. Army surveys. The railroad industry was nurtured by Army protection, and financially supported-in part-by movements of Army freight to nearby posts. Maintenance of the nation's standing Army and its logistical needs has spurred scientific and technical improvements for the railroads. The hard-earned lessons of logistics, developed in the Spanish American War and in World War I, allowed the Army to mobilize for international wars and opened the way for international commerce to learn the lessons of efficient, low cost shipping.

Integrity:

Properly considered a subtype of transportation, railroad related properties are increasingly rare on Army property because many railroad lines have been removed or so modified as to compromise their historic integrity. However, railroad property types still exist within Army bases and may be identified if the physical characteristics and associative qualities are recognized. The associative value of railroad related features identified at former Quartermaster depots is likely to be much greater than similar features identified at former Army Air Corps bases.

Individual properties include spur lines, locomotive sheds, roundhouses, terminals, bridges and trestles. An evaluation of their physical integrity is the first step toward determining if individual properties have historic significance. It is also important to remember that railroad-related properties may also be significant as a group. In this case deteriorated properties may retain integrity as a significant and distinguishable entity whose components lack individual distinction.

For example, a coal trestle and roadbed leading to the trestle may be historically significant, even if the rails and ties have been removed. Railroad properties may also retain their historic integrity, even with major modifications, as contributing elements in an historic district as supporting buildings related to an industrial or storage complex. Few railroad related facilities retain their original use although warehouses built adjacent to railroad lines are a possible exception as they often are still used as storage facilities.

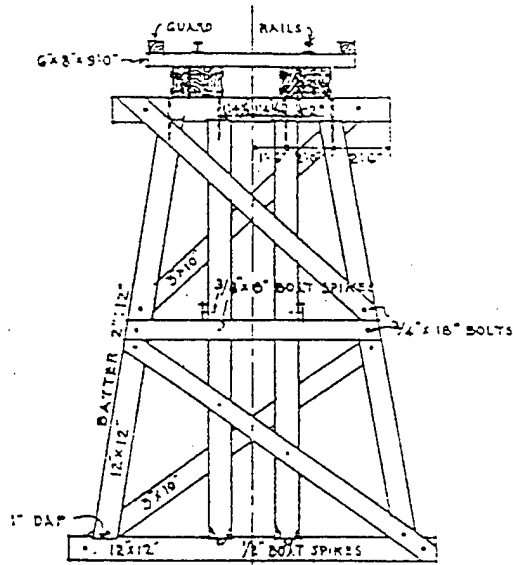

ELEVATION OF DENT

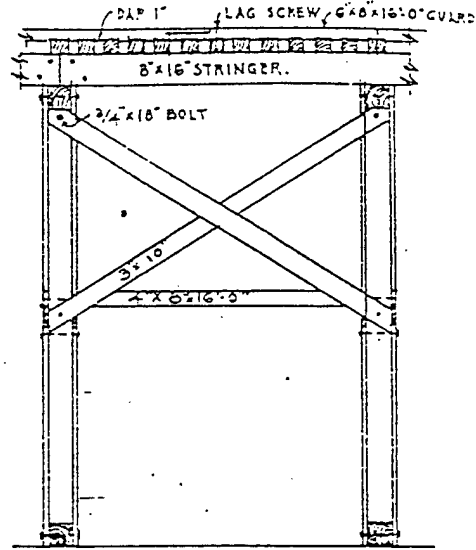

SIDE ELEVATION

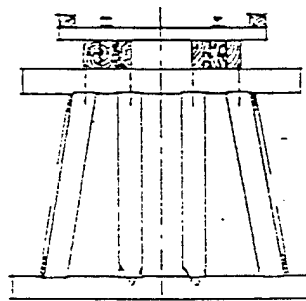

FOR HEIGHTS 10FT LESS.

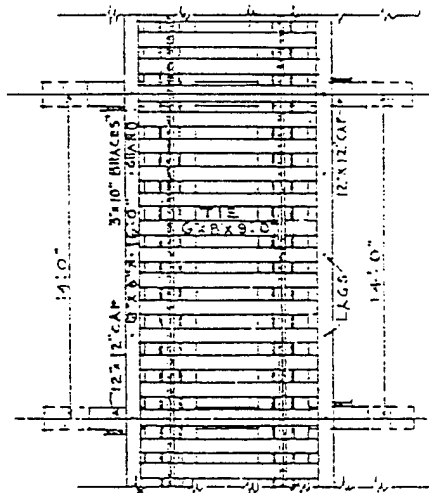

PLAN

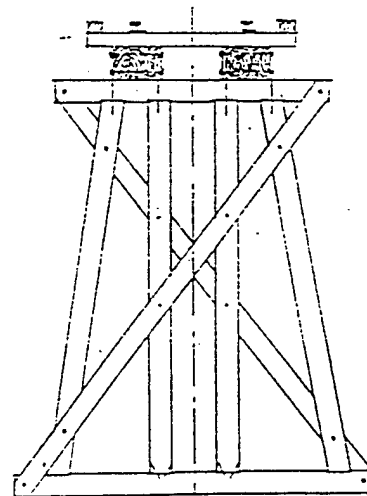

FOR HEIGHTS 10FT TO 18FT

RR-1

FOR DETAILS SEE DRAWING G17-26

CONSTRUCTION DIVISION OF THE ARMY STANDARD RAILWAY TRESTLE

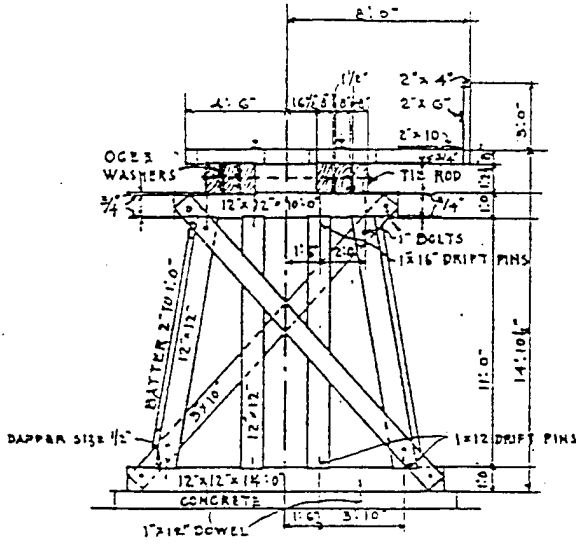

ELEVATION OF BENT

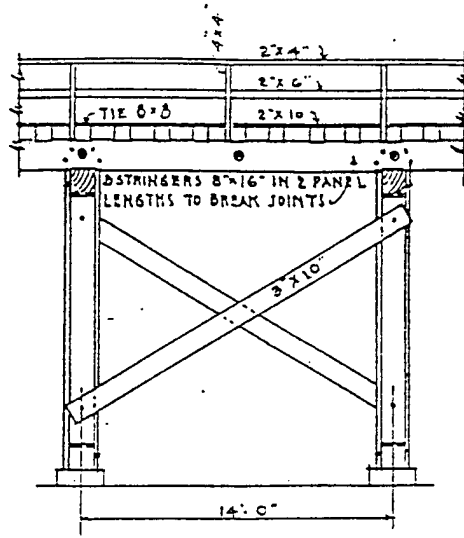

SIDE ELEVATION

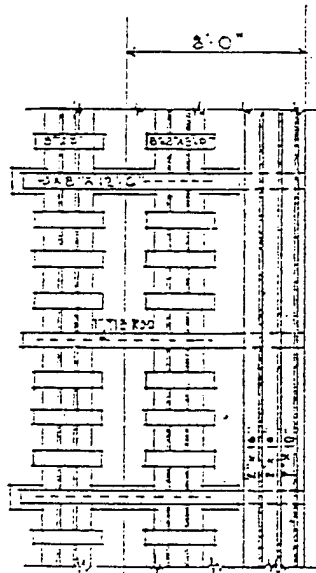

PLAN

NOTES

- POSTS SIZED OR DAPPED INTO CAPS AND SILLS.
- TIES FASTENED TO STRINGERS WITH 3/4x12 LAG SCREWS.
- STRINGERS FASTENED TO CAPS WITH 3/4x22 DRIFT PINS
- EVERY 3RD SPAN BRACED LONGITUDINALLY.
- USE 3-8x16 STRINGERS UNDER EACH RAIL
- FOR 12:0" OR 14:0" SPANS

RR-2

FOR DETAILS SEE DRAWING G17-24

CONSTRUCTION DIVISION OF THE ARMY
STANDARD RAILWAY COAL TRESTLE

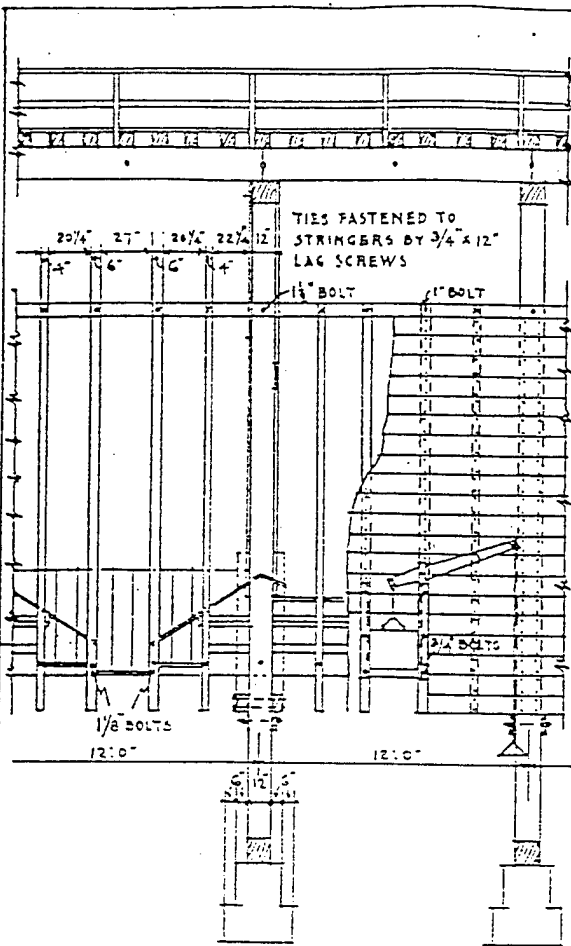

SIDE ELEVATION

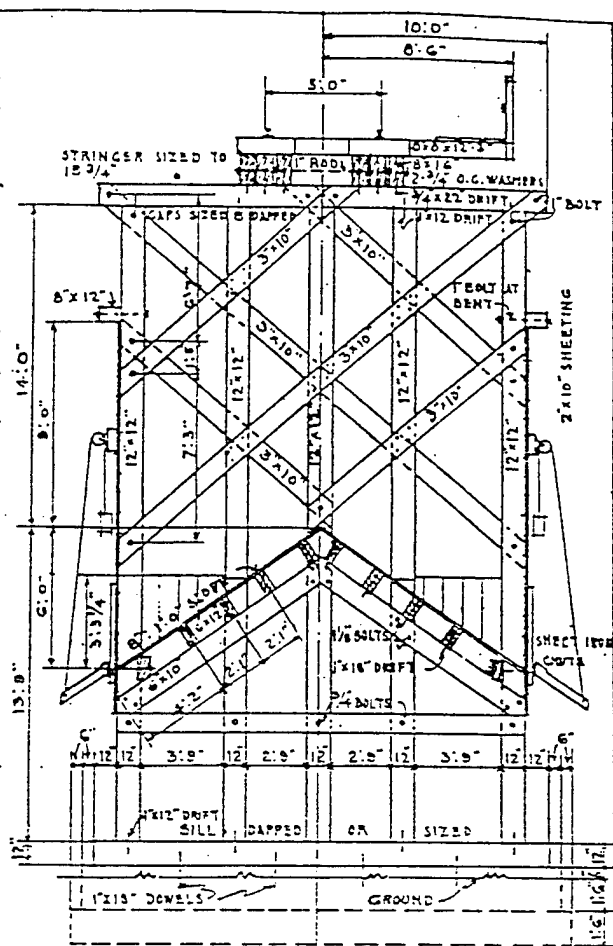

SECTION & ELEVATION

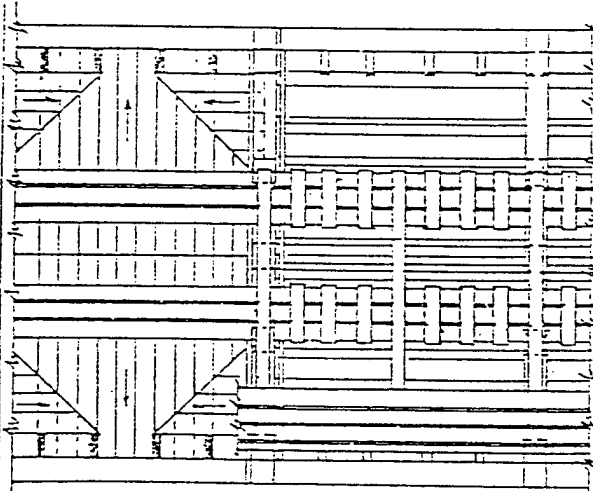

PLAN

CAPACITY:- 5.6 TDNS PER. FT.
 USE Ogee WASHERS FOR ALL BOLTS

RR-3

FOR DETAILS SEE DRAWING 617-25

CONSTRUCTION DIVISION OF THE ARMY
 STANDARD TIMBER COAL POCKET
 RAILROAD PLAN

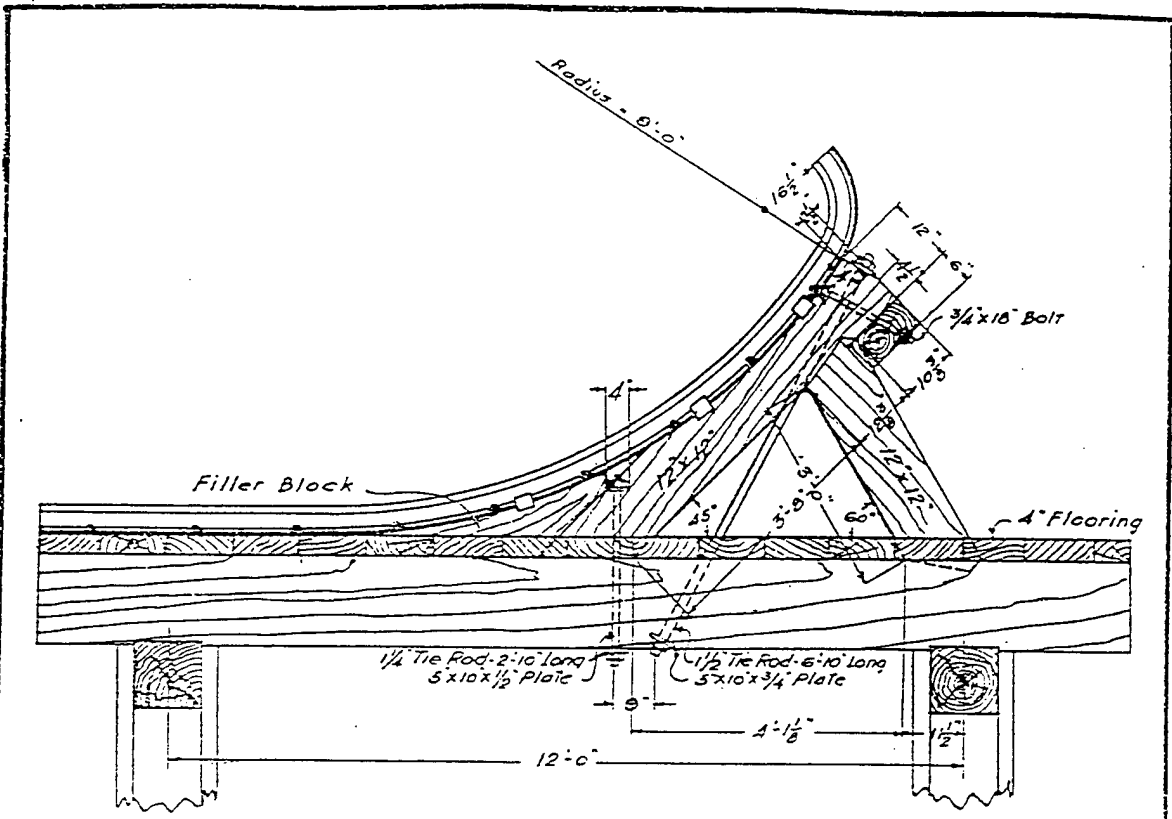

SIDE ELEVATION

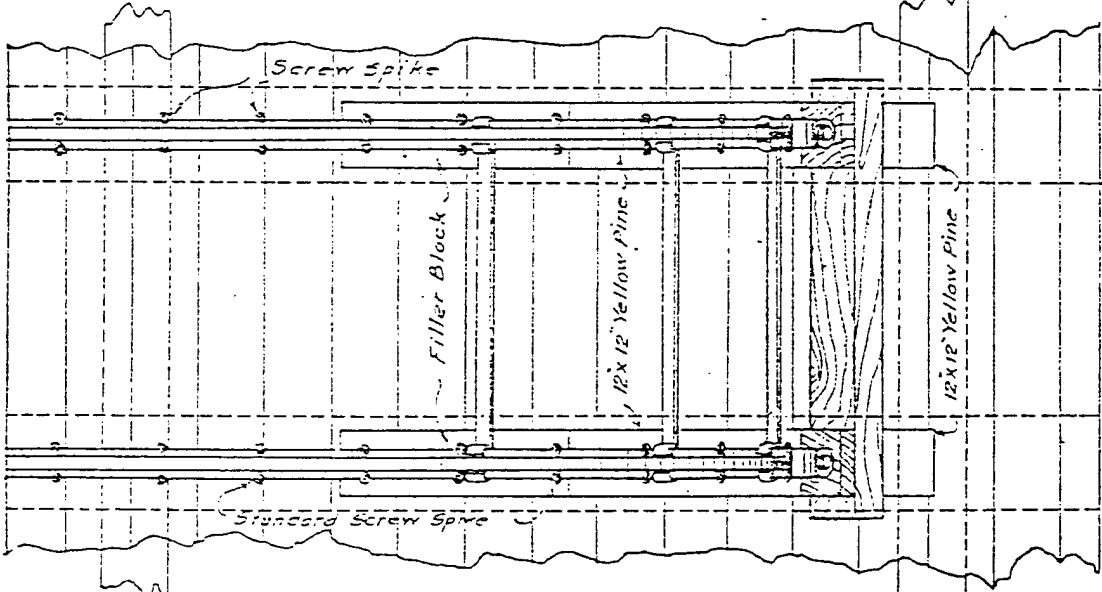

PLAN

RR-5

CONSTRUCTION DIVISION OF THE ARMY
STANDARD TRESTLE BUMPER
RAILWAYS

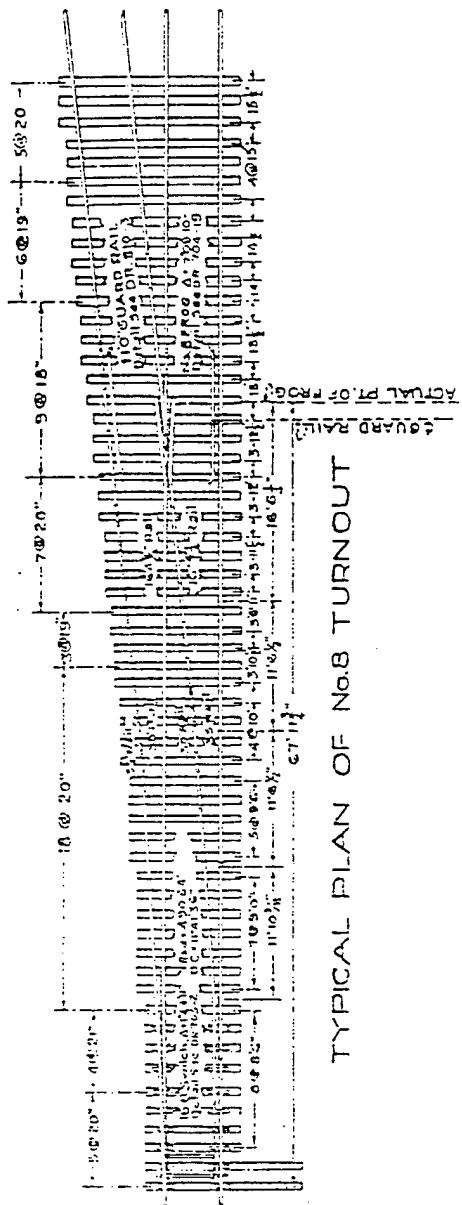

TYPICAL PLAN OF No.8 TURNOUT

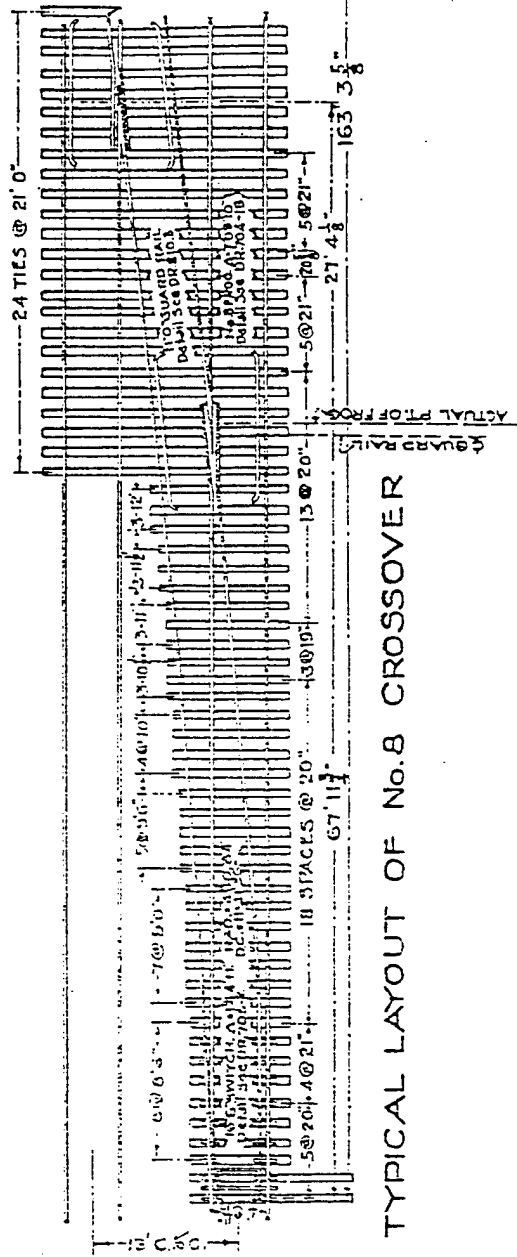

TYPICAL LAYOUT OF No.8 CROSSOVER

RR-4

CONSTRUCTION DIVISION OF THE ARMY
 No.8 TURNOUT AND CROSSOVER
 RAILWAYS

¹ Forest G. Hill, *Roads, Rails, & Waterways: The Army Engineers and Early Transportation* (Norman: University of Oklahoma, 1957), 44-131.

² Goodwin, R. Christopher and Associates, *National Historic Context for Department of Defense Installations, 1790-1940; Volume I* (Baltimore, MD: United States Army Corps of Engineers, 1995), 248.

³ Russell F. Weigley, *History of the United States Army* (Bloomington: Indiana University Press, 1984), 300-302.

Context Study of the United States Quartermaster General Standard Plans

DATABASE LISTING

Introduction

The following tables present a list of all the buildings in this study, sorted in a tabular database. This provides a means for locating a particular category or type of building. The buildings have been sorted by five defining characteristics (fields), each represented by a column in the database table:

- 1) BUILDING TYPE
- 2) STANDARD PLAN DRAWING NUMBER
- 3) INSTALLATION
- 4) BUILDING NAME
- 5) DATE

“Manual Cnstr Div” entries, under the Installation column, indicate that the building was identified from tables or drawings in the *Manual of the Construction Division of the Army* rather than from working plans from a specific installation. These tables immediately follow this introduction.

There are two additional fields in the database: “Date” and “Drwng”. The entries under the “Date” column were taken from the drawings or tables referred to in the drawings and are the dates upon which the drawing(s) were approved.

The entries under the column labeled “Drwng” designate whether a drawing for the building is included in the study. An “X” in the column means that a drawing was included. When a building is identified but no drawing is included, it means 1) that the building name, date, and number were located on one of the tables from the Construction Division Manual noted above, but no drawing was found, or 2) the building name, date, and number were supplied by information from an installation, but no drawing was included.

The ten different building types identified are those as defined for this study. The building name, drawing number, and date have been taken from the original drawings of the building, from the Construction Division Manual tables, or from information supplied by the installation where the building is located.

All Quartermaster Corps standard building plan numbers were taken either from drawings, from tables in the Quartermaster Corps Manuals, or from surveys and real estate data sheets provided by installations. Most Quartermaster Corps standard plans are numeric, some carry a letter designator, for example: 610-232 or 122-B. The Quartermaster Corps also constructed buildings to the specifications of the Surgeon General’s Office, these plans are identified by an “SGO-“

prefix. Two standard building plan types, shown in **Table 1**, were assigned prefixes because no standard plan number appeared on drawings in these categories.

TABLE 1: NEW PREFIXES FOR STANDARDIZED PLANS

Standardized Plan Number Prefix	Designation of Plans With this Prefix
LA-	Landscape Architecture
RR-	Railroad Related Property

By using the enclosed database tables, personnel can identify and compare the buildings at their own installations with those in this study to determine whether they may be part of the Quartermaster Standard Plans system. The information presented in the introduction to each building type can be then used to help determine the history, status, and context of each building. This allows personnel to better define the historical development of their installations and identify those buildings which may be valuable historic resources worthy of special attention or treatment.

Sorted by: TYPE

TYPE	BUILDING	DATE	INSTALLATI	DRWNG	STD_PLAN
1 a	Fire Station	1909	F.E. Warren AFB		98-E
1 a	Fire Station	1909	F.E. Warren AFB		98-G
1 a	Fire Station	1916	Fort Chaffee		800-800
1 a	Fire Station, 24'x77'	1918	Manual Cnstr Div		620-341
1 a	Fire Station, 31'x88'	1918	Manual Cnstr Div		620-365
1 a	Fire Station, 31'x88'	1918	Manual Cnstr Div		620-441
1 a	Fire Station, 31'x103	1918	Manual Cnstr Div		620-447
1 b	Guard House	1911	F.E. Warren AFB		206
1 b	Post Guard House	1901	F.E. Warren AFB		30-C
1 b	Unit Guardhouse	1916	Fort Chaffee		700-260
1 b	Unit Guardhouse	1916	Fort Chaffee		700-260.1
1 b	Guard House, 60x85	1891	Fort McPherson		9
1 b	Artillery Guard House	1908	Fort Riley, KS	X	A-13-9
1 b	Cavalry Stable Guard Building	1896	Fort Riley, KS	X	George Ruhlen
1 b	Guard house, Regimental 20'x56'	1918	Manual Cnstr Div		620-331
1 b	Guard House, Type 1, 20x56	1918	Manual Cnstr Div		652-214
1 b	Guard House, Mobilization Camps	1916	Manual for QMC	X	16-11
1 c	Post Headquarters	1909	F.E. Warren AFB		1-729 S.P.S.
1 c	Administration Building	1911	F.E. Warren AFB		112-F
1 c	Admin Building (Artillery)	1911	F.E. Warren AFB		122-F
1 c	Fld. Office	1916	Fort Chaffee		7093-451
1 c	Administration Bldg. (Hosp.)	1916	Fort Chaffee		800-1417
1 c	Administration Bldg.	1916	Fort Chaffee		800-204
1 c	Sta. HQ. Office	1916	Fort Chaffee		800-214
1 c	Sm Finance. Bldg.	1916	Fort Chaffee		800-219
1 c	Med. Detachment Admin. Bldg.	1916	Fort Chaffee		800-A101210
1 c	Admin Bldg? No Title	N.D.	Fort Riley, KS	X	6139-307
1 c	Administration Building	N.D.	Fort Riley, KS		Geo. E. Pond
1 c	Proposed Administration Building	N.D.	Fort Riley, KS		Geo. E. Pond
1 c	Admin. Building, 20' x 84'	1918	Manual Cnstr Div		620-327
1 c	Administration Building, 20'x49'	1918	Manual Cnstr Div		620-356
1 c	Welfare Bldg, 84x96	1918	Manual Cnstr Div		6399-120
1 c	Admin Building, Mobilization Camps	1916	Manual for QMC	X	16-10
1 c	Operations Building	1940	Marshall Field		613-9365
1 c	Operations Building	1940	Marshall Field,		6139-366
1 d	Post & Telegraph Office	1907	F.E. Warren AFB		177
1 d	Post Office	1916	Fort Chaffee		800-217
1 d	Post Office, Type PO-1	1937	Fort Riley, KS	X	700-298
1 d	Post Office Building, 32x51	1918	Manual Cnstr Div		620-374
2 a	Radio Range Bldg.	1916	Fort Chaffee		800-905
2 b	Tel. & TeL Bldg.	1916	Fort Chaffee		800-907
2 b	Tel. & Teleg. Bldg, 20x70	1918	Manual Cnstr Div		620-328
2 b	Telegraph office & Quarters, 20x110	1918	Manual Cnstr Div		620-418
3 a	Academic Building	1938	Fort Riley, KS	X	6139-310
3 a	Gas Instruction, 16x30	1918	Manual Cnstr Div		6143-2
3 a	Classroom Building, 30' x 60'	1918	Manual Cnstr Div		620-450

Sorted by: TYPE

TYPE	BUILDING	DATE	INSTALLATI	DRWNG	STD_PLAN
3 a	Classroom Building, 49'x150	1918	Manual Cnstr Div		620-469 & 470
3 a	Classroom Building, 30'x60'	1918	Manual Cnstr Div		620-507
3 b	Cavalry Drill Hall	1907	F.E. Warren AFB		97-A
4 a	Dispensary (Cavalry)	1909	F.E. Warren AFB		247
4 a	Dental Clinic	1916	Fort Chaffee		700-467
4 a	Clinic	1916	Fort Chaffee		700-476
4 a	Clinic	1916	Fort Chaffee		700-484
4 a	Infirmary	1916	Fort Chaffee		800-1429
4 a	Dental Clinic	1916	Fort Chaffee		800-1445
4 a	Clinic	1916	Fort Chaffee		800-1513
4 a	Dental Clnc & Cont. Ward, 34x130	1939	Fort McPherson		6217-65, 74, 76
4 a	Infirmary - Large	1940	Fort Riley, KS		700-279
4 a	Dispensary	N.D.	Fort Riley, KS	X	Geo. E. Pond
4 a	Infirmary - Medical, 30'x63'	1918	Manual Cnstr Div		620-302
4 a	Infirmary & Dental Ops Bldg. 30'x88	1918	Manual Cnstr Div		620-307 & 308
4 a	Infirm./Dntl Dorm Bldg, 30'x88'	1918	Manual Cnstr Div		620-310 & 311
4 a	Infirmary - Medical, Addition, 24'x	1918	Manual Cnstr Div		620-333
4 a	Infirmary - Medical, 30'x77'	1918	Manual Cnstr Div		620-368 to 375
4 a	Infirmary - Medical, 30'x105'	1918	Manual Cnstr Div		620-382
4 a	Infirmary - Medical, 30'x112'	1918	Manual Cnstr Div		620-383 & 384
4 a	Infirmary - Medical, 30'x98'	1918	Manual Cnstr Div		620-392 & 393
4 a	Infirmary - Medical, 30'x56'	1918	Manual Cnstr Div		620-449
4 a	Delousing Plant, 48x84	1918	Manual Cnstr Div		632-551
4 a	Delousing Plant, 60x204	1918	Manual Cnstr Div		632-552
4 a	Recruit Exam. Bldg / Shop	1918	Manual Cnstr Div	X	SB 19
4 a	Delousing Plant, 54x120	1918	Manual Cnstr Div	X	SB 21
4 b	Physiotherapy	1916	Fort Chaffee		700-348
4 b	X-Ray Building	1916	Fort Chaffee		700-462
4 b	Ward Combination	1916	Fort Chaffee		700-463
4 b	Recreation Bldg. Patients	1916	Fort Chaffee		700-520
4 b	Morgue	1916	Fort Chaffee		800-1454
4 b	Detention Ward	1916	Fort Chaffee		800-1424
4 b	Detention Hut, 20'x20'	1918	Manual Cnstr Div		620-326
4 b	Garage for Ambulances, 22'x47'	1918	Manual Cnstr Div		620-496
4 b	Hospital Typ Kitchen Layouts	1918	Manual Cnstr Div	X	SB 14
4 b	Layout: Hospital	1918	Manual Cnstr Div	X	SGO-A
4 b	Layout: Head House	1918	Manual Cnstr Div	X	SGO-A1
4 b	Typical Hosp Admin Bldg	1918	Manual Cnstr Div	X	SGO-B
4 b	Typical Hosp Laboratory Bldg	1918	Manual Cnstr Div	X	SGO-F
4 b	Typical Hosp Operating Pavillion	1918	Manual Cnstr Div	X	SGO-G
4 b	Typical Hosp General Mess & Kitchen	1918	Manual Cnstr Div	X	SGO-I1 & I32
4 b	Typical Hosp General Mess & Kitchen	1918	Manual Cnstr Div	X	SGO-I28
4 b	Typical Hosp Receiving Ward	1918	Manual Cnstr Div	X	SGO-J
4 b	Typical Hosp Single Wards	1918	Manual Cnstr Div	X	SGO-K1
4 b	Typical Hosp Single Wards	1918	Manual Cnstr Div	X	SGO-K34
4 b	Typical Hosp Single Wards	1918	Manual Cnstr Div	X	SGO-K35
4 b	Typ. Hosp Phys Thrpy & Amusmnt Hall	1918	Manual Cnstr Div	X	SGO-S & T
4 b	Hospital, Mobilization Camps	1916	Manual for QMC	X	16-13
4 b	Ward Building, Mobilization Camps	1916	Manual for QMC	X	16-14

Sorted by: TYPE

TYPE	BUILDING	DATE	INSTALLATI	DRWNG	STD_PLAN
5 a	Artillery Workshop	1904	F.E. Warren AFB		59-K
5 a	Artillery Shop	1908	F.E. Warren AFB		59-V
5 a	Ordnance Shop w/crane	1916	Fort Chaffee		652-419
5 a	Ordnance Shop Boiler House	1916	Fort Chaffee		652-423
5 a	C & E Repair Shop	1916	Fort Chaffee		800-1000
5 a	Q.M. Utility Shop	1916	Fort Chaffee		800-603
5 a	Shop Building	1916	Fort Riley, KS	X	407
5 a	Shop - Utilities	1937	Fort Riley, KS	X	700-317
5 a	Packing & Crating shop	1938	Fort Riley, KS	X	A-8-12
5 a	Battery Workshops	N.D.	Fort Riley, KS	X	Geo. E. Pond
5 a	Shop, 20x36	1918	Manual Cnstr Div		620-372
5 a	Shop, Clothing etc 30x102	1918	Manual Cnstr Div		620-381
5 a	Shop, QMaster, 2 bldgs each, 36x106	1918	Manual Cnstr Div		620-390
5 a	Stable Guard , 20x21	1918	Manual Cnstr Div		620-395
5 a	Shop, Cot repair, 40x36	1918	Manual Cnstr Div		620-436
5 a	Shop, Clothing, etc, 60x100	1918	Manual Cnstr Div		620-437
5 a	Shop, Tent Treating, 36x40	1918	Manual Cnstr Div		620-439
5 a	Shop, Tent Repair, 40x60	1918	Manual Cnstr Div		620-440
5 a	Shop, Clothing, etc 28x132, 28x162	1918	Manual Cnstr Div		620-467
5 a	Ordnance Repair Shop 30x106	1918	Manual Cnstr Div		620-508
5 a	Shop, Ordnance Repair, 30x80	1918	Manual Cnstr Div		652-19
5 b	Rendering Plant, 32x48	1918	Manual Cnstr Div		620-435
5 b	Coffee Roasting & Grinding Plant	1918	Manual Cnstr Div		620-490 & 491
5 b	Pyrotech Plant Type D, 20x35	1918	Manual Cnstr Div		652-152
5 b	Pyrotech Plant Type 1 & 2, 30x161	1918	Manual Cnstr Div		652-157
5 b	Pyrotech Plant Type J & J1, 20x35	1918	Manual Cnstr Div		652-158
5 b	Refrigerating & Ice Making Plant	1918	Manual Cnstr Div	X	SB 28
5 c1	Post Bakery	1903	F.E. Warren AFB		1-1180
5 c1	Bakery	1916	Fort Chaffee		800-682
5 c1	Bakery	1902	Fort Riley, KS	X	49H
5 c1	Bakery, 30'x70'	1918	Manual Cnstr Div		620-340
5 c1	Bakery, 40'x136 & 51'x62'	1918	Manual Cnstr Div		620-361 & 362
5 c1	Bakery, 40'x136'	1918	Manual Cnstr Div		620-379
5 c1	Bakery, 30'x50'	1918	Manual Cnstr Div		620-428
5 c1	Bakery 33'x51'	1918	Manual Cnstr Div		620-505
5 c1	Field Bakery, Mobilization Camps	1916	Manual for QMC	X	16-16
5 c2	Laundry	1911	F.E. Warren AFB		234-B
5 c2	Laundry	1911	F.E. Warren AFB		243-B
5 c2	Laundry	1916	Fort Chaffee		800-1029
5 c2	Laundry Steam Plant	1916	Fort Chaffee		800-1619
5 c2	Typical Dry Cleaning Plant	1930	Fort Riley, KS		633-165
5 c2	Laundry, 72x216, 5-10,000 men	1918	Manual Cnstr Div		633-130
5 c2	Laundry, 36x108, 1-2,000 men	1918	Manual Cnstr Div		633-140
5 c2	Standard Laundry, 10-20,000 men	1918	Manual Cnstr Div		SB 20
5 d1	Cavalry Granary	1909	F.E. Warren AFB		193-A
5 d1	Q.M. Forage Storehouse	1908	F.E. Warren AFB		53-A
5 d1	Coal Shed	1904	F.E. Warren AFB		67-B

Sorted by: TYPE

TYPE	BUILDING	DATE	INSTALLATI	DRWNG	STD_PLAN
5 d1	Coal Shed	1909	F.E. Warren AFB		67-J
5 d1	Cold Storage	1916	Fort Chaffee		700-1265R
5 d1	Storehouse	1916	Fort Chaffee		700-461
5 d1	Fld. Office Water Stg. Tank	1916	Fort Chaffee		7093-454.2
5 d1	Rm. & Storage Bays	1916	Fort Chaffee		800-607
5 d1	Salvage Warehouse	1916	Fort Chaffee		800-652
5 d1	Warehouse (Insulated)	1916	Fort Chaffee		800-654
5 d1	Storehouse	1916	Fort Chaffee		800-663
5 d1	Storehouse	1916	Fort Chaffee		800-664
5 d1	Ice Storage	1916	Fort Chaffee		800-777
5 d1	Ordnance Storehouse, 30x50	1897	Fort McPherson		103-A
5 d1	Subsistence Storehouse	1897	Fort McPherson		106
5 d1	Film Vault, size illegible	?	Fort McPherson		6217-127?
5 d1	Clinic 28 beds, 34x130, 9x30	1930	Fort McPherson		6217-36 to 45
5 d1	Granary	1907	Fort Riley, KS	X	193
5 d1	Cold Storage Bldg	?	Fort Riley, KS	X	800-1226
5 d1	Commissary Store House	1905	Fort Riley, KS	X	A-19-1
5 d1	Store House, Regmtl, 20xvar.	1918	Manual Cnstr Div		620-318
5 d1	Warehouse, Clothing, 60x100	1918	Manual Cnstr Div		620-385 & 386
5 d1	Store House, Salvage, 60x168	1918	Manual Cnstr Div		620-412 & 413
5 d1	Storage Depot/admin Bldg, 140x160	1918	Manual Cnstr Div		6271-7
5 d1	Storehouse, General, #1, 161x501	1918	Manual Cnstr Div		652-41
5 d1	Storehouse, General, #2	1918	Manual Cnstr Div		652-74
5 d1	Typ Em'gncy Str'g Whse Toilet Rms	1918	Manual Cnstr Div	X	SB 10
5 d1	Store House, Divisional, 60x168	1918	Manual Cnstr Div	X	SB 16
5 d1	Emg'ncy Whse C'prtmt & Group Plan	1918	Manual Cnstr Div	X	SB 25
5 d1	Typ. Em'gncy Str'g Whse Admin Bldg	1918	Manual Cnstr Div	X	SB 26
5 d1	Emg'ncy Whse, Open Shed	1918	Manual Cnstr Div	X	SB 27
5 d1	Store House, Mobilization Camps	1916	Manual for QMC	X	16-12
5 d1	Paint Oil & Dope House	1940	Marshall Field,	X	702-118
5 d2	Light Battery Gun Shed	1905	F.E. Warren AFB		104
5 d2	Light Battery Gun Shed	1908	F.E. Warren AFB		104-F
5 d2	Q.M. Store House, Artillery	1909	F.E. Warren AFB		198
5 d2	Artillery Gun Shed	1909	F.E. Warren AFB		209
5 d2	Ammunition Storehouse	1910	F.E. Warren AFB		262
5 d2	Powder Magazine	1910	F.E. Warren AFB		263
5 d2	Magazines igloo type	1916	Fort Chaffee		642-535
5 d2	Magazines igloo type	1916	Fort Chaffee		652-535
5 d2	Armament	1916	Fort Chaffee		800-210
5 d2	Magazine, Post Ordnance	1934	Fort Lewis, WA	X	19-2-70
5 d2	Magazine, 12x15, brick	1893	Fort McPherson		46
5 d2	Ordnance Store House	N.D.	Fort Riley, KS	X	Geo. E. Pond
5 d2	Magazine, Black P'wdr, 16x22	1918	Manual Cnstr Div		6196-104
5 d2	Shed - Wagon or Gun, 29xvar.	1918	Manual Cnstr Div		620-332
5 d2	Magazine, 20'x20'	1918	Manual Cnstr Div		620-370
5 d2	Magazine, 24'x60'	1918	Manual Cnstr Div		620-371
5 d2	Magazine, brick w/corr steel rf, 10	1918	Manual Cnstr Div		620-452
5 d2	Magazine, Smokeless pwdr, 32x96	1918	Manual Cnstr Div		652-146
5 d2	Shed, Dock, 60x122	1918	Manual Cnstr Div		652-165
5 d2	Magazine, Type 13, 26x42	1918	Manual Cnstr Div		652-169
5 d2	Primer & Fuse house #1, 32x96	1918	Manual Cnstr Div		652-173

Sorted by: TYPE

TYPE	BUILDING	DATE	INSTALLATI	DRWNG	STD_PLAN
5 d2	Primer & Fuse house #2, 32x96	1918	Manual Cnstr Div		652-174
5 d2	Magazine, Type 10, 49x208	1918	Manual Cnstr Div		652-179
5 d2	Magazine, Type 11, H.E. 26x42	1918	Manual Cnstr Div		652-180
5 d2	Magazine, Type 12, 26x42	1918	Manual Cnstr Div		652-31
5 d2	Magazine, Type 1 & Type 2	1918	Manual Cnstr Div	X	SB 23
6 a	Oil House 25x 49'	1916	Fort Chaffee		700-323
6 a	Oil Shed	1916	Fort Chaffee		700-384
6 a	Heating Plant	1916	Fort Chaffee		7093-501
6 a	Station QM Office Boiler Hs.	1916	Fort Chaffee		800-201
6 a	Boiler/Pump House	1905	Fort McPherson		132-H
6 a	Electric Sub Station, 10x12	1909	Fort McPherson		4-936
6 a	Oil house, 20x30	1918	Manual Cnstr Div		620-396
6 a	Boiler Houses	1918	Manual Cnstr Div		620-492
6 a	Transformer Sta. Type 1, 20x36	1918	Manual Cnstr Div		652-81
6 a	Elec Distrib Syst, Street Lighting	1918	Manual Cnstr Div	X	SB 11
6 a	Elec Distrib Syst, 2ndary Lines	1918	Manual Cnstr Div	X	SB 12
6 b	Utility Office	1931	F.E. Warren AFB		59-U
6 b	Water Tank (tower)	1903	F.E. Warren AFB		68-C
6 b	Hose House, 30x50	1898	Fort McPherson		Post
6 b	Sewage Treat. Plnt, Cntrl Hse	1942	Fort Riley, KS	X	408-204
6 b	Hose House (Type A & B) 6'x7'	1918	Manual Cnstr Div		620-445 & 446
6 c	Crematory	1908	F.E. Warren AFB		1-620-B
6 c	Incinerator - trash only	1939	F.E. Warren AFB		414-43-228
6 c	Incinerator	1916	Fort Chaffee		414/43/330
6 c	Crematory	1908	Fort D.A. Russel		1-620-B
6 c	Incinerator	1938	Fort Riley, KS		A-13-1
6 c	Waste & Transfer Station, 20x130	1918	Manual Cnstr Div		620-432
6 c	Standard Incinerator	1918	Manual Cnstr Div	X	SB 8
7 a	Recreational Bldg.	1916	Fort Chaffee		700-310
7 a	Nurses Recreation Room	1916	Fort Chaffee		800-451
7 a	Med. Detachment Recr.	1916	Fort Chaffee		800-459
7 a	Recreation Bldg.	1916	Fort Chaffee		800-460
7 a	Post Exchange & Gymnasium	1906	Fort Riley, KS	X	174
7 a	Post Exchange & Gymnasium	N.D.	Fort Riley, KS	X	Geo. E. Pond
7 a	Lecture Hall, 51x77	1918	Manual Cnstr Div		608-104
7 a	Auditorium, 200x300	1918	Manual Cnstr Div	X	SB 24
7 b	Sports Arena	1916	Fort Chaffee		800-465
7 b	Gymnasium	1940	Fort D.A. Russel		6560-145 - 179
7 c	Chapel	1916	Fort Chaffee		700-1800
7 d	Service Club	1916	Fort Chaffee		700-1775
7 d	Officers' Club	1916	Fort Chaffee		800-809
7 f	Artillery Exchange	1910	F.E. Warren AFB		122-B
7 f	Cavalry Post Exchange	1910	F.E. Warren AFB		122-b
7 f	Post Exchange	1905	F.E. Warren AFB		158

Sorted by: TYPE

TYPE	BUILDING	DATE	INSTALLATI	DRWNG	STD_PLAN
7 f	Commissary Building	1910	F.E. Warren AFB		186
7 f	Exchange	1916	Fort Chaffee		700-297
7 f	Post Exchange	1916	Fort Chaffee		800-1412
7 f	Post Exchange, 32x91	1918	Manual Cnstr Div		620-359
7 f	Post Exchange, Mobilization Camps	1916	Manual for QMC	X	16-15
7 g	War Dept Theatre	1939	F.E. Warren AFB		608-360 to 366
7 g	Band Stand, Cavalry & Artillery	1911	F.E. Warren AFB		64-B
7 g	Theatre w/Stage	1916	Fort Chaffee		700-1212.1
7 g	War Dept Theater	1939	Fort D.A. Russel		608-360 - 366
7 g	War Dept Theatre, 85x49	1939	Fort McPherson		6217-105 to 107
7 g	Theatre, Class a, 120x187	1918	Manual Cnstr Div		608-24
7 g	Theatre, Liberty, Class D	1918	Manual Cnstr Div		608-31to34&106
7 g	Liberty Theatre, 60x120	1918	Manual Cnstr Div		620-499 & 500
8 a	Lab Building for Vet Hosp	1907	Fort Riley, KS	X	A-14-16
9 a1	Nurses Quarters	1906	F.E. Warren AFB		152-E
9 a1	Bachelor Officers Quarters	1908	F.E. Warren AFB		152-G
9 a1	Bachelor Officers Quarters	1910	F.E. Warren AFB		152-L
9 a1	Nurses' Quarters	1916	Fort Chaffee		700-1240
9 a1	Guest House	1916	Fort Chaffee		700-1290
9 a1	BOQ, 33x140, 33x45, 12x33	1904	Fort McPherson	X	152-B
9 a1	Nurses Quarters, 13 nurses	1933	Fort McPherson		707-102 to 107
9 a1	B.O.Q	1902	Fort Riley, KS	X	152
9 a1	B.O.Q.	N.D.	Fort Riley, KS	X	188
9 a1	Officers Quarters, Lge, Mob. Camps	1916	Manual for QMC	X	16-2
9 a1	Officers Quarters, Sml, Mob. Camps	1916	Manual for QMC	X	16-3
9 a2	Artillery Barracks	1904	F.E. Warren AFB		150
9 a2	Artillery Barracks	1908	F.E. Warren AFB		181
9 a2	Teamsters Quarters	1910	F.E. Warren AFB		258
9 a2	Hospital Corps Barracks	1912	F.E. Warren AFB		276
9 a2	Q.M. Barracks for M.T.	1900	F.E. Warren AFB		53-D
9 a2	Cavalry Band Barracks	1909	F.E. Warren AFB		61-F
9 a2	Med Dcthmnt Bar (and 6560-140--142)	1939	F.E. Warren AFB		621-1325--1346
9 a2	Detachment Barracks	1931	F.E. Warren AFB		621-850 & 851
9 a2	Medical Detachment Bar	1939	F.E. Warren AFB		6560-140--142
9 a2	Cavalry Barracks	1910	F.E. Warren AFB		75-M
9 a2	Med. Detachment Barracks	1916	Fort Chaffee		700-1204
9 a2	Prisoner's Barracks	1916	Fort Chaffee		800-443
9 a2	Hosp Corps Bar.	1908	Fort D.A. Russel		1-729-S.P.S.
9 a2	Hospital Corps Barracks	1912	Fort D.A. Russel		2-76
9 a2	Med. Detachment Barracks	1939	Fort D.A. Russel		6560-140 - 142
9 a2	Double barracks, 39x150	1904	Fort McPherson		75-G
9 a2	Band Barracks	1907	Fort Riley, KS	X	61-F
9 a2	Cavalry Barracks	1902	Fort Riley, KS	X	75
9 a2	Barracks	1938	Fort Riley, KS		A-19-14
9 a2	Quarters for Packers	N.D.	Fort Riley, KS	X	A-2-17
9 a2	Artillery Barracks, 80 Men	1896	Fort Riley, KS	X	Geo. E. Pond
9 a2	Cavalry Barracks	N.D.	Fort Riley, KS	X	Geo. E. Pond
9 a2	Barrack, 30'x60'	1918	Manual Cnstr Div		620-313

Sorted by: TYPE

TYPE	BUILDING	DATE	INSTALLATI	DRWNG	STD_PLAN
9 a2	Barrack, 30'x50'	1918	Manual Cnstr Div		620-342
9 a2	Dtchmnt Bar., w/out mess 20' x var.	1918	Manual Cnstr Div		620-353
9 a2	Detach. Bar., w/mess 20' x var.	1918	Manual Cnstr Div		620-355
9 a2	Barrack, 30'x40'	1918	Manual Cnstr Div		620-366
9 a2	Prisoner's Barrack & Yard, 30'x9	1918	Manual Cnstr Div		620-373
9 a2	Guard Barrack, 30'x90'	1918	Manual Cnstr Div		620-373-A
9 a2	Barrack & lavatory, 43'x120'	1918	Manual Cnstr Div		620-457 & 458
9 a2	Dormitory for men, 28x113	1918	Manual Cnstr Div		6307-110
9 a2	Dormitory & Dining Room, 29x136	1918	Manual Cnstr Div		6339-111
9 a2	Dormitories w/Mess	1918	Manual Cnstr Div	X	SB 22
9 a2	Typical Barracks, 66 Men	1918	Manual Cnstr Div	X	SB 4
9 a2	NCO Barracks, Mobilization Camps	1916	Manual for QMC	X	16-4
9 a2	Barrack, Enl'std Men, Mob. Camps	1916	Manual for QMC	X	16-5
9 a2	Barracks	1938	Marshall Field,	X	621-1072
9 b1	Lavatory	1916	Fort Chaffee		700-285
9 b1	Outhouse for Cavalry Barracks	N.D.	Fort Riley, KS	X	Geo. E. Pond
9 b1	Lav. w/out shwrs: 17x14, 17x21, 17x	1918	Manual Cnstr Div		620-324
9 b1	Bath House, 9'x8' to 9'x32'	1918	Manual Cnstr Div		620-336
9 b1	Lavatory w/showers, 20x49	1918	Manual Cnstr Div		620-345
9 b1	Lavatory w/showers, 20x42	1918	Manual Cnstr Div		620-346
9 b1	Lavatory w/showers, 20x35	1918	Manual Cnstr Div		620-347
9 b1	Lavatory w/showers, 20x21, x28	1918	Manual Cnstr Div		620-348
9 b1	Lavatory w/showers, 14x14, 14x20	1918	Manual Cnstr Div		620-349
9 b1	Shower shelter & wash house, 20x80	1918	Manual Cnstr Div		620-451
9 b1	Lavatory w/showers, 20x50	1918	Manual Cnstr Div		620-523
9 b1	Typical Lavatories	1918	Manual Cnstr Div	X	SB 6
9 b1	Typical Lavatories Details	1918	Manual Cnstr Div	X	SB 7
9 b1	Latrine, Mobilization Camps	1916	Manual for QMC	X	16-8
9 b1	Bath House, Mobilization Camps	1916	Manual for QMC	X	16-9
9 b2	Officers Mess	1916	Fort Chaffee		700-1127
9 b2	Mess Patients	1916	Fort Chaffee		700-44+A476
9 b2	Medical Detachment Mess	1916	Fort Chaffee		700-446
9 b2	Officers' Mess	1916	Fort Chaffee		700-450
9 b2	Nurses' Mess	1916	Fort Chaffee		700-451
9 b2	152 Man Mess	1916	Fort Chaffee		7093-921
9 b2	112 Man Mess	1916	Fort Chaffee		800-847
9 b2	E.M. Mess	1916	Fort Chaffee		800-849
9 b2	E.M. Mess (M-248 less one 8'bay)	1916	Fort Chaffee		800-851
9 b2	Mess Hall, 144x177, 800 men	1893	Fort McPherson		42
9 b2	Kitchen & Mess, 24x100, 31x33	1930	Fort McPherson		6217-47 to 57
9 b2	Dbl Mess Hall & Kit, 140x42,	1906	Fort McPherson		93-K
9 b2	Meat Inspection Platform, 10'x66'	1918	Manual Cnstr Div		620-429
9 b2	Mess Building, 30x120 , x132, x144	1918	Manual Cnstr Div		620-442
9 b2	Refrigeration Plant, 20x72	1918	Manual Cnstr Div		620-471 & 472
9 b2	Regrigeration Cooling Tower,	1918	Manual Cnstr Div		620-473
9 b2	Cafeteria, 105x192	1918	Manual Cnstr Div		6209-113
9 b2	Cafeteria, 54x189	1918	Manual Cnstr Div		6339-131
9 b2	Cafeteria, 132x173	1918	Manual Cnstr Div		6370-106
9 b2	Cafeteria, 110x171	1918	Manual Cnstr Div		6383-110
9 b2	Cafeteria, 156x200	1918	Manual Cnstr Div		6403-111
9 b2	Typ Hospital Kitchen Layouts	1918	Manual Cnstr Div	X	SB 13

Sorted by: TYPE

TYPE	BUILDING	DATE	INSTALLATI	DRWNG	STD_PLAN
9 b2	Typical Mess Buildings	1918	Manual Cnstr Div	X	SB 15
9 b2	Det Hut & Kitchen, Det & Qrntrn Camp	1918	Manual Cnstr Div	X	SB 18
9 b2	Kit. & Dining Rm, 72 Men, Mob. Cmps	1916	Manual for QMC	X	15-6
9 b2	Mess Building, Mobilization Camps	1916	Manual for QMC	X	16-6
9 b2	Kitchen, Mobilization Camps	1916	Manual for QMC	X	16-7
9 c1	Double NCO Quarters, type B	1933	F.E. Warren AFB		625-2510 & 2518
9 c1	Double NCO Quarters, type A	1933	F.E. Warren AFB		625-2510 - 2511
9 c1	Double Set N.C.S.O. Quarters	1885	F.E. Warren AFB		82-D
9 c1	N.C.O. Quarters	1909	F.E. Warren AFB		82-K
9 c1	Civillian Employees Quarters	1911	F.E. Warren AFB		82-P
9 c1	Double NCO Quarters	1931	F.E. Warren AFB		8682-D
9 c1	Hospital Sergeant's Quarters	1905	F.E. Warren AFB		Unknown
9 c1	Double NCO Quarters	1931	Fort D.A. Russel		625-1543 & 1544
9 c1	Double NCO Quarters	1933	Fort D.A. Russel		625-2510 & 2511
9 c1	Quarters for Civilian Employees	1909	Fort Riley, KS	X	258
9 c1	Double NCO Quarters, 2 sty, brick	1930	Fort Riley, KS		625-1444
9 c1	Double NCO Quarters 2 sty, brick	1930	Fort Riley, KS	X	625-1530
9 c1	Double NCO Quarters, w sty, brick	1930	Fort Riley, KS		625-1543
9 c1	NCO Quarters - type c - brick	1932	Fort Riley, KS	X	625-1556
9 c1	Double NCO Quarters, 2 sty, stone	1938	Fort Riley, KS	X	625-3570-3
9 c1	Double NCO Quarters, 2 sty, brick	1935	Fort Riley, KS	X	625-3571
9 c1	Double NCO Quarters, 2 story, stone	1938	Fort Riley, KS	X	625-3571-3
9 c1	Double NCO Quarters, 2 sty, brick	1935	Fort Riley, KS	X	625-3572
9 c1	Double NCO Quarters, 2 story stone	1938	Fort Riley, KS	X	625-3572-3
9 c1	NCO Double Quarters	1930	Fort Riley, KS	X	625-541
9 c1	Four Set Civillian's Quarters	1909	Fort Riley, KS	X	82-N
9 c1	Quarters, no designation	1939	Fort Riley, KS	X	A-2-3
9 c1	Frame Quarters for NCO	1928	Fort Riley, KS	X	Geo. E. Pond
9 c1	Non-Commissioned Officers Quarters	N.D.	Fort Riley, KS	X	Geo. E. Pond
9 c1	Quarters for Steam Heating Engineer	N.D.	Fort Riley, KS	X	Geo. E. Pond
9 c1	Housing, 4 families, 38x53	1918	Manual Cnstr Div		6309-121
9 c1	Housing, 1 family, 24x30	1918	Manual Cnstr Div		6309-150
9 c1	Housing, Boarding, 27x38	1918	Manual Cnstr Div		6309-160
9 c1	Housing, 1 family, 24x36	1918	Manual Cnstr Div		6309-180
9 c1	Housing, 1 family, 24x32	1918	Manual Cnstr Div		6309-190
9 c1	Housing, 2 family, 25x36	1918	Manual Cnstr Div		6309-200
9 c2	Officers Quarters	1888	F.E. Warren AFB		(Illegible)2
9 c2	Double Set Officer's Quarters	1905	F.E. Warren AFB		120-C
9 c2	Double Set Officers Quarters	1905	F.E. Warren AFB		120-D
9 c2	Double Lieutenants Quarters	1909	F.E. Warren AFB		120-F
9 c2	Officers Quarters	1910	F.E. Warren AFB		120-H
9 c2	Company Ofcr 4 Set Apt	1931	F.E. Warren AFB		129
9 c2	Double Officers Quarters	1906	F.E. Warren AFB		142-A
9 c2	Double Officers Quarters	1909	F.E. Warren AFB		142-B
9 c2	Officers Quarters	1910	F.E. Warren AFB		142-D
9 c2	Field Officers Quarters	1905	F.E. Warren AFB		145
9 c2	Field Officers Quarters	1909	F.E. Warren AFB		145-D
9 c2	Field Officers Quarters	1910	F.E. Warren AFB		145-F
9 c2	Field Officers Quarters	1911	F.E. Warren AFB		235-A
9 c2	4 Set Officers Quarters	1911	F.E. Warren AFB		237-B

Sorted by: TYPE

TYPE	BUILDING	DATE	INSTALLATI	DRWNG	STD_PLAN
9 c2	Company Officer's Quarters	1932	F.E. Warren AFB		625-1486 & 87
9 c2	Double Set Officer's Quarters	1905	F.E. Warren AFB		90
9 c2	C.O.'s Quarters	1903	F.E. Warren AFB		95-A
9 c2	Officers' Quarters	1916	Fort Chaffee		700-1254
9 c2	Officers' Quarters	1916	Fort Chaffee		700-1257
9 c2	Officers Quarters	1916	Fort Chaffee		800-306
9 c2	Officers' Quarters	1916	Fort Chaffee		800-307
9 c2	Field Officers Qtrs	1909	Fort D.A. Russel		215
9 c2	4-Set Officers Qtrs	1911	Fort D.A. Russel		267-B
9 c2	Company Officers Qtrs	N.D.	Fort D.A. Russel		625-1486 & 1487
9 c2	Quarters for Two Lieutenants	1907	Fort Riley, KS	X	120-H
9 c2	Quarters for Field Officer	1905	Fort Riley, KS	X	145-D
9 c2	Officers Quarters 4 Officers	1909	Fort Riley, KS	X	237-A
9 c2	Field Officers Quarters	1932	Fort Riley, KS	X	625-1341
9 c2	4 Family Apt. House, Company Ofcrs	1928	Fort Riley, KS		625-803
9 c2	4 Family Apt. House, Company Ofcrs	1930	Fort Riley, KS	X	625-806
9 c2	Four Family Apartment House	1930	Fort Riley, KS	X	625-808
9 c2	Quarters, no designation	1939	Fort Riley, KS	X	A-4-7
9 c2	Quarters, no designation	1938	Fort Riley, KS	X	A-4-9
9 c2	Proposed Field Officers Quarters	N.D.	Fort Riley, KS	X	Geo. E. Pond
9 c2	Quarters for Commanding Officer	N.D.	Fort Riley, KS	X	Geo. E. Pond
9 c2	Double Quarters for Officer	1902	Fort Riley, KS	X	SPL 3-368
9 c2	Officers Quarters	1902	Fort Riley, KS		SPL 3-381
9 c2	Officers Quarters, 20x49	1918	Manual Cnstr Div		620-337
9 c2	Officers Quarters, 30xvar.	1918	Manual Cnstr Div		620-343
9 c2	Officers Quarters, 20x28	1918	Manual Cnstr Div		620-344
9 c2	Officers Quarters, 30xvar.	1918	Manual Cnstr Div		620-354
9 c2	Officers Quarters, 20xvar.	1918	Manual Cnstr Div		620-363
9 c2	Officers Quarters, 20xvar.	1918	Manual Cnstr Div		620-364
9 c2	Officer's Qtrs, 20x21 types A,B,C	1918	Manual Cnstr Div		620-369
9 c2	Typical 2 Story Officers Qtrs	1918	Manual Cnstr Div	X	SB 5
9 c2	Field Officers Quarters	1932	Marshall Field,	X	625-1301
9 c2	Field Officers Quarters	1933	Marshall Field,	X	625-1340
9 c2	Company Officers Quarters	1932	Marshall Field,	X	625-2491
9 d1	Revised Plan of Engineer Garage	1937	Fort Riley, KS	X	A-20-12
9 d1	NCO Garages	1940	Fort Riley, KS	X	A-20-7
9 d1	Garage, 50' x var.	1918	Manual Cnstr Div		620-301
9 d1	Garage, 65' x 108'	1918	Manual Cnstr Div		620-322 & 323
9 d1	Garage, 30' x var.	1918	Manual Cnstr Div		620-511
9 d1	Garage, open, 50'xvar.	1918	Manual Cnstr Div		620-524
9 d1	Garage, closed, 70'x180'	1918	Manual Cnstr Div		620-525
9 d1	Garage, Mechanical Repair, 140x144	1918	Manual Cnstr Div		6242-5
9 d1	Garage, 61x164	1918	Manual Cnstr Div		6311-105
9 d1	Garage, Ordinance, 50xvar.	1918	Manual Cnstr Div		652-17
10 a1	Air Corps Hangar	1930	Chief of Air Cor	X	695-272
10 a1	Air Corps Hangar, E Design	1931	Chief of Air Cor	X	695-284
10 a1	Standard All Steel Airplane Hangar	?	Chief of Air Ser	X	6342-158 ?
10 a1	Airplane Hangar	N.D.	Fort Riley, KS	X	Butler Mfg Co
10 a1	Standard Steel & Wood Hangars	1919	Manual Cnstr Div	X	SB 9
10 b1	Hay Shed	1926	F.E. Warren AFB		102-F

Sorted by: TYPE

TYPE	BUILDING	DATE	INSTALLATI	DRWNG	STD_PLAN
10 b1	Hay Shed	1909	F.E. Warren AFB		102-G
10 b1	Cavalry Stable	1906	F.E. Warren AFB		139
10 b1	Artillery Stables	1904	F.E. Warren AFB		139-C
10 b1	Artillery or Infantry Stables	1908	F.E. Warren AFB		139-K
10 b1	Stable for Inf. & Officers Mounts	1908	F.E. Warren AFB		139-Q
10 b1	Veterinary Hospital	1908	F.E. Warren AFB		166
10 b1	Stable Guard House, DBL Building	1905	F.E. Warren AFB	X	39-C
10 b1	Stable Guard House & Shops	1909	F.E. Warren AFB		39-G
10 b1	Stable Guard House	1909	F.E. Warren AFB		39-L
10 b1	Stable Guard & Shops	1909	F.E. Warren AFB		39-N
10 b1	Stable Guard & shops	1911	F.E. Warren AFB		39-Q
10 b1	Wagon Shed	1906	F.E. Warren AFB		60-G
10 b1	Quartermaster Stable, 129x67	1908	Fort McPherson		139-H
10 b1	Quartermaster Stable, 145x67	1910	Fort McPherson		139-L
10 b1	Stables	1938	Fort Riley, KS	X	14-7-illegible
10 b1	Stables	1938	Fort Riley, KS	X	14-9-illegible
10 b1	Stable Guard House	Ileg	Fort Riley, KS		39-C
10 b1	Stable - School of Equitation	1939	Fort Riley, KS	X	A-14-12
10 b1	Stable	1938	Fort Riley, KS		A-14-4
10 b1	Battery Stables	N.D.	Fort Riley, KS	X	E. B. Williston
10 b1	Cavalry Stables	N.D.	Fort Riley, KS	X	Geo. E. Pond
10 b1	Cantonment: R'mnt Sta 7500 Animals	1918	Manual Cnstr Div	X	404-48
10 b1	Stable - open 24xvar.	1918	Manual Cnstr Div		620-376
10 b1	Hay Shed, 60'x165'	1918	Manual Cnstr Div		620-378
10 b1	Stable - closed, 29xvar.	1918	Manual Cnstr Div	X	SB 17
10 b1	Animal Shelter, Mobilization Camps	1916	Manual for QMC	X	16-17
10 c1	Gas Sta. & Pump House	1916	Fort Chaffee		800-601
10 c1	Q.M. Gas Station	1932	Fort Riley, KS	X	A-5-21
10 c1	Auto & Mtr Serv Sta, 35'x41'	1918	Manual Cnstr Div		620-397
10c2	Road Cross Section, Typical	1918	Manual Cnstr Div	X	LA-1
10 c2	Vehicle Shed	1910	F.E. Warren AFB		60-H
10 c2	Motor Repair Shop	1916	Fort Chaffee		700-1390
10 c2	Motor School	1916	Fort Chaffee		700-374
10 c2	Motor Repair Shop	1916	Fort Chaffee		700+A42-374
10 c2	Grease Rack & Insp. Rack	1916	Fort Chaffee		800-1026
10 c2	Motor Repair Shop	1916	Fort Chaffee		800-606
10 c2	Dispatching House	1916	Fort Chaffee		800-661
10 c2	Dispatcher's Office	1939	Fort Riley, KS		A-19-4
10 c2	Shop, Motor Repair, 60x130	1918	Manual Cnstr Div		620-387 & 388
10 c2	Shop, Motor Repair, 75x96	1918	Manual Cnstr Div		620-478 & 479
10 c2	Storage, Vehicles # 3, 161xvar	1918	Manual Cnstr Div		652-188
10 c2	Storage, Vehicles, #1, 113x513	1918	Manual Cnstr Div		652-43
10 c2	Vehicle Shelter, Mobilization Camps	1916	Manual for QMC	X	16-18
10 d1	Trestle, Coal	1918	Fort Lewis, WA	X	RR 9
10 d1	Standard Railway Trestle	1918	Manual Cnstr Div	X	RR-1
10 d1	Std. Railway Coal Trestle	1918	Manual Cnstr Div	X	RR-2
10 d1	Std. Timber Coal Pocket	1918	Manual Cnstr Div	X	RR-3
10d1	Cantonment: RR Terminal	1918	Manual Cnstr Div	X	610-238
10 d1	Std. Trestle Bumper, Railways	1918	Manual Cnstr Div	X	RR-5

Sorted by: TYPE

TYPE	BUILDING	DATE	INSTALLATI	DRWNG	STD_PLAN
10 d2	Turnout & Crossover, Railways	1918	Manual Cnstr Div	X	RR-4
10 d2	Roadbed Sectons, Railways	1918	Manual Cnstr Div	X	RR-6
11 a	Cantonment: Div HQ	1918	Manual Cnstr Div	X	610-221 & 227
11 a	Cantonment: Rgmt Inf, Brigd HQ	1918	Manual Cnstr Div	X	610-222
11 a	Cantonment: Rgmt Lt Art'ly	1918	Manual Cnstr Div	X	610-225
11 a	Contonment: Rgmt Hvy Art'ly	1918	Manual Cnstr Div	X	610-226
11 a	Cantonment: Camp Center	1918	Manual Cnstr Div	X	610-232
11 a	Cantonment: Depot Brgd HQ	1918	Manual Cnstr Div	X	610-233
11 a	Cantonment: Qrnt'n Camp 1000 men	1918	Manual Cnstr Div	X	610-274
11 a	Typ L'scp Pl'tg: CO & Dbl CO Qtrs	1935	Office of QMG	X	630-100
11 a	Typical Street Tree Planting	1935	Office of QMG	X	630-102
11 a	Typ L'scp Pl'tg: Th'tre, Hosp, Chpl	1935	Office of QMG	X	630-103
11 a	Typ. L'scp Pl'tg: HQ, Admin, BOQ	1935	Office of QMG	X	630-Illegible
11a	Road Cross Sections, Typical	1918	Manual Cnstr Div	X	LA-2
11a	Northern & Southern Constr Zones	1918	Manual Cnstr Div	X	620-320-2-182
11a	Typical 1 Story Building	1918	Manual Cnstr Div	X	SB 1
11a	Typical 2 Story Building	1918	Manual Cnstr Div	X	SB 2
11a	Typical 2 Sty Building, Details	1918	Manual Cnstr Div	X	SB 3
11a	Temporary Bldgs for Mob Camps	1916	Manual for QMC	X	16-1
11a	Terminal General Plan	1918	Manual Cnstr Div	X	RR-7
11a	Terminals General Plans	1918	Manual Cnstr Div	X	RR-8

Sorted by: STANDARDIZED PLAN NUMBER

STD_PLAN	BUILDING	DATE	INSTALLATION	DRWNG	TYPE
(Illegible)2	Officers Quarters	1888	F.E. Warren AFB		9 c2
1-1180	Post Bakery	1903	F.E. Warren AFB		5 c1
1-620-B	Crematory	1908	F.E. Warren AFB		6 c
1-729 S.P.S.	Post Headquarters	1909	F.E. Warren AFB		1 c
1-729-S.P.S.	Hosp Corps Bar.	1908	Fort D.A. Russel		9 a2
102-F	Hay Shed	1926	F.E. Warren AFB		10 b1
102-G	Hay Shed	1909	F.E. Warren AFB		10 b1
103-A	Ordnance Storehouse, 30x50	1897	Fort McPherson		5 d1
104	Light Battery Gun Shed	1905	F.E. Warren AFB		5 d2
104-F	Light Battery Gun Shed	1908	F.E. Warren AFB		5 d2
106	Subsistence Storehouse	1897	Fort McPherson		5 d1
112-F	Administration Building	1911	F.E. Warren AFB		1 c
120-C	Double Set Officer's Quarters	1905	F.E. Warren AFB		9 c2
120-D	Double Set Officers Quarters	1905	F.E. Warren AFB		9 c2
120-F	Double Lieutenants Quarters	1909	F.E. Warren AFB		9 c2
120-H	Officers Quarters	1910	F.E. Warren AFB		9 c2
120-H	Quarters for Two Lieutanants	1907	Fort Riley, KS	X	9 c2
122-B	Artillery Exchange	1910	F.E. Warren AFB		7 f
122-b	Cavalry Post Exchange	1910	F.E. Warren AFB		7 f
122-F	Admin Building (Artillery)	1911	F.E. Warren AFB		1 c
129	Company Ofcr 4 Set Apt	1931	F.E. Warren AFB		9 c2
132-E	Pump House (& N.C.O. Quarters)	1905	F.E. Warren AFB		6 b
132-H	Boiler/Pump House	1905	Fort McPherson		6 a
139	Cavalry Stable	1906	F.E. Warren AFB		10 b1
139-C	Artillery Stables	1904	F.E. Warren AFB		10 b1
139-H	Quartermaster Stable, 129x67	1908	Fort McPherson		10 b1
139-K	Artillery or Infantry Stables	1908	F.E. Warren AFB		10 b1
139-L	Quartermaster Stable, 145x67	1910	Fort McPherson		10 b1
139-Q	Stable for Inf. & Officers Mounts	1908	F.E. Warren AFB		10 b1
14-7-illegible	Stables	1938	Fort Riley, KS	X	10 b1
14-9-illegible	Stables	1938	Fort Riley, KS	X	10 b1
142-A	Double Officers Quarters	1906	F.E. Warren AFB		9 c2
142-B	Double Officers Quarters	1909	F.E. Warren AFB		9 c2
142-D	Officers Quarters	1910	F.E. Warren AFB		9 c2
145	Field Officers Quarters	1905	F.E. Warren AFB		9 c2
145-D	Field Officers Quarters	1909	F.E. Warren AFB		9 c2
145-D	Quarters for Field Officer	1905	Fort Riley, KS	X	9 c2
145-F	Field Officers Quarters	1910	F.E. Warren AFB		9 c2
15-6	Kit. & Dining Rm, 72 Men, Mob. Cmps	1916	Manual for QMC	X	9 b2
150	Artillery Barracks	1904	F.E. Warren AFB		9 a2
152	B.O.Q	1902	Fort Riley, KS	X	9 a1
152-B	BOQ, 33x140, 33x45, 12x33	1904	Fort McPherson	X	9 a1
152-E	Nurses Quarters	1906	F.E. Warren AFB		9 a1
152-G	Bachelor Officers Quarters	1908	F.E. Warren AFB		9 a1
152-L	Bachelor Officers Quarters	1910	F.E. Warren AFB		9 a1
158	Post Exchange	1905	F.E. Warren AFB		7 f
16-1	Temporary Bldgs for Mob Camps	1916	Manual for QMC	X	11 a
16-10	Admin Building, Mobilization Camps	1916	Manual for QMC	X	1 c
16-11	Guard House, Mobilization Camps	1916	Manual for QMC	X	1 b
16-12	Store House, Mobilization Camps	1916	Manual for QMC	X	5 d1
16-13	Hospital, Mobilization Camps	1916	Manual for QMC	X	4 b

Sorted by: STANDARDIZED PLAN NUMBER

STD_PLAN	BUILDING	DATE	INSTALLATION	DRWNG	TYPE
16-14	Ward Building, Mobilization Camps	1916	Manual for QMC	X	4
16-15	Post Exchange, Mobilization Camps	1916	Manual for QMC	X	7
16-16	Field Bakery, Mobilization Camps	1916	Manual for QMC	X	5 c1
16-17	Animal Shelter, Mobilization Camps	1916	Manual for QMC	X	10 b1
16-18	Vehicle Shelter, Mobilization Camps	1916	Manual for QMC	X	10 c2
16-2	Officers Quarters, Lge, Mob. Camps	1916	Manual for QMC	X	9 a1
16-3	Officers Quarters, Sml, Mob. Camps	1916	Manual for QMC	X	9 a1
16-4	NCO Barracks, Mobilization Camps	1916	Manual for QMC	X	9 a2
16-5	Barrack, Enl'std Men, Mob. Camps	1916	Manual for QMC	X	9 a2
16-6	Mess Building, Mobilization Camps	1916	Manual for QMC	X	9 b2
16-7	Kitchen, Mobilization Camps	1916	Manual for QMC	X	9 b2
16-8	Latrine, Mobilization Camps	1916	Manual for QMC	X	9 b1
16-9	Bath House, Mobilization Camps	1916	Manual for QMC	X	9 b1
166	Veterinary Hospital	1908	F.E. Warren AFB		10 b1
174	Post Exchange & Gymnasium	1906	Fort Riley, KS	X	7 a
177	Post & Telegraph Office	1907	F.E. Warren AFB		1 d
181	Artillery Barracks	1908	F.E. Warren AFB		9 a2
186	Commissary Building	1910	F.E. Warren AFB		7 f
188	B.O.Q.	N.D.	Fort Riley, KS	X	9 a1
19-2-70	Magazine, Post Ordnance	1934	Fort Lewis, WA	X	5 d2
193	Granary	1907	Fort Riley, KS	X	5 d1
193-A	Cavalry Granary	1909	F.E. Warren AFB		5 d1
196-A	Ice House	1910	F.E. Warren AFB		6 b
198	Q.M. Store House, Artillery	1909	F.E. Warren AFB		5 d2
2-76	Hospital Corps Barracks	1912	Fort D.A. Russel		9 a
206	Guard House	1911	F.E. Warren AFB		1 b
209	Artillery Gun Shed	1909	F.E. Warren AFB		5 d2
215	Field Officers Qtrs	1909	Fort D.A. Russel		9 c2
234-B	Laundry	1911	F.E. Warren AFB		5 c2
235-A	Field Officers Quarters	1911	F.E. Warren AFB		9 c2
237-A	Officers Quarters 4 Officers	1909	Fort Riley, KS	X	9 c2
237-B	4 Set Officers Quarters	1911	F.E. Warren AFB		9 c2
243-B	Laundry	1911	F.E. Warren AFB		5 c2
247	Dispensary (Cavalry)	1909	F.E. Warren AFB		4 a
258	Teamsters Quarters	1910	F.E. Warren AFB		9 a2
258	Quarters for Civilian Employees	1909	Fort Riley, KS	X	9 c1
262	Ammunition Storehouse	1910	F.E. Warren AFB		5 d2
263	Powder Magazine	1910	F.E. Warren AFB		5 d2
267-B	4-Set Officers Qtrs	1911	Fort D.A. Russel		9 c2
276	Hospital Corps Barracks	1912	F.E. Warren AFB		9 a2
30-C	Post Guard House	1901	F.E. Warren AFB		1 b
39-C	Stable Guard House, DBL Building	1905	F.E. Warren AFB	X	10 b1
39-C	Stable Guard House	lleg	Fort Riley, KS		10 b1
39-G	Stable Guard House & Shops	1909	F.E. Warren AFB		10 b1
39-L	Stable Guard House	1909	F.E. Warren AFB		10 b1
39-N	Stable Guard & Shops	1909	F.E. Warren AFB		10 b1
39-Q	Stable Guard & shops	1911	F.E. Warren AFB		10 b
4-936	Electric Sub Station, 10x12	1909	Fort McPherson		6 a

Sorted by: STANDARDIZED PLAN NUMBER

STD_PLAN	BUILDING	DATE	INSTALLATION	DRWNG	TYPE
404-48	Cantonment: R'mnt Sta 7500 Animals	1918	Manual Cnstr Div	X	10 b1
407	Shop Building	1916	Fort Riley, KS	X	5 a
408-204	Sewage Treat. Plnt, Cntrl Hse	1942	Fort Riley, KS	X	6 b
414-43-228	Incinerator - trash only	1939	F.E. Warren AFB		6 c
414/43/330	Incinerator	1916	Fort Chaffee		6 c
42	Mess Hall, 144x177, 800 men	1893	Fort McPherson		9 b2
46	Magazine, 12x15, brick	1893	Fort McPherson		5 d2
49H	Bakery	1902	Fort Riley, KS	X	5 c1
53-A	Q.M. Forage Storehouse	1908	F.E. Warren AFB		5 d1
53-D	Q.M. Barracks for M.T.	1900	F.E. Warren AFB		9 a2
59-K	Artillery Workshop	1904	F.E. Warren AFB		5 a
59-U	Utility Office	1931	F.E. Warren AFB		6 b
59-V	Artillery Shop	1908	F.E. Warren AFB		5 a
60-G	Wagon Shed	1906	F.E. Warren AFB		10 b1
60-H	Vehicle Shed	1910	F.E. Warren AFB		10 c2
608-104	Lecture Hall, 51x77	1918	Manual Cnstr Div		7 a
608-24	Theatre, Class a, 120x187	1918	Manual Cnstr Div		7 g
608-31to34&106	Theatre, Liberty, Class D	1918	Manual Cnstr Div		7 g
608-360 - 366	War Dept Theater	1939	Fort D.A. Russel		7 g
608-360 to 366	War Dept Theatre	1939	F.E. Warren AFB		7 g
61-F	Cavalry Band Barracks	1909	F.E. Warren AFB		9 a2
61-F	Band Barracks	1907	Fort Riley, KS	X	9 a2
610-221 & 227	Cantonment: Div HQ	1918	Manual Cnstr Div	X	11 a
610-222	Cantonment: Rgmt Inf, Brigd HQ	1918	Manual Cnstr Div	X	11 a
610-225	Cantonment: Rgmt Lt Art'ly	1918	Manual Cnstr Div	X	11 a
610-226	Contonment: Rgmt Hvy Art'ly	1918	Manual Cnstr Div	X	11 a
610-232	Cantonment: Camp Center	1918	Manual Cnstr Div	X	11 a
610-233	Cantonment: Depot Brgd HQ	1918	Manual Cnstr Div	X	11 a
610-238	Cantonment: RR Terminal	1918	Manual Cnstr Div	X	10d1
610-274	Cantonment: Qrnt'n Camp 1000 men	1918	Manual Cnstr Div	X	11 a
613-9365	Operations Building	1940	Marshall Field		1 c
6139-307	Admin Bldg? No Title	N.D.	Fort Riley, KS	X	1 c
6139-310	Academic Building	1938	Fort Riley, KS	X	3 a
6139-366	Operations Building	1940	Marshall Field,		1 c
6143-2	Gas Instruction, 16x30	1918	Manual Cnstr Div		3 a
6196-104	Magazine, Black P'wdr, 16x22	1918	Manual Cnstr Div		5 d2
620-301	Garage, 50' x var.	1918	Manual Cnstr Div		9 d1
620-302	Infirmery - Medical, 30'x63'	1918	Manual Cnstr Div		4 a
620-307 & 308	Infirmery & Dental Ops Bldg. 30'x88	1918	Manual Cnstr Div		4 a
620-310 & 311	Infirm./Dntl Dorm Bldg, 30'x88'	1918	Manual Cnstr Div		4 a
620-313	Barrack, 30'x60'	1918	Manual Cnstr Div		9 a2
620-318	Store House, Regmtl, 20xvar.	1918	Manual Cnstr Div		5 d1
620-320-2-182	Northern & Southern Constr Zones	1918	Manual Cnstr Div	X	11a
620-322 & 323	Garage, 65' x 108'	1918	Manual Cnstr Div		9 d1
620-324	Lav. w/out shwrs: 17x14, 17x21, 17x	1918	Manual Cnstr Div		9 b1
620-326	Detention Hut, 20'x20'	1918	Manual Cnstr Div		4 b
620-327	Admin. Building, 20' x 84'	1918	Manual Cnstr Div		1 c
620-328	Tel. & Teleg. Bldg, 20x70	1918	Manual Cnstr Div		2 b
620-331	Guard house, Regimental 20'x56'	1918	Manual Cnstr Div		1 b

Sorted by: STANDARDIZED PLAN NUMBER

STD_PLAN	BUILDING	DATE	INSTALLATION	DRWNG	TYPE
620-332	Shed - Wagon or Gun, 29xvar.	1918	Manual Cnstr Div		5 d2
620-333	Infirmary - Medical, Addition, 24'x	1918	Manual Cnstr Div		4 a
620-336	Bath House, 9'x8' to 9'x32'	1918	Manual Cnstr Div		9 b1
620-337	Officers Quarters, 20x49	1918	Manual Cnstr Div		9 c2
620-340	Bakery, 30'x70'	1918	Manual Cnstr Div		5 c1
620-341	Fire Station, 24'x77'	1918	Manual Cnstr Div		1 a
620-342	Barrack, 30'x50'	1918	Manual Cnstr Div		9 a2
620-343	Officers Quarters, 30xvar.	1918	Manual Cnstr Div		9 c2
620-344	Officers Quarters, 20x28	1918	Manual Cnstr Div		9 c2
620-345	Lavatory w/showers, 20x49	1918	Manual Cnstr Div		9 b1
620-346	Lavatory w/showers, 20x42	1918	Manual Cnstr Div		9 b1
620-347	Lavatory w/showers, 20x35	1918	Manual Cnstr Div		9 b1
620-348	Lavatory w/showers, 20x21, x28	1918	Manual Cnstr Div		9 b1
620-349	Lavatory w/showers, 14x14, 14x20	1918	Manual Cnstr Div		9 b1
620-353	Dtchmnt Bar., w/out mess 20' x var.	1918	Manual Cnstr Div		9 a2
620-354	Officers Quarters, 30xvar.	1918	Manual Cnstr Div		9 c2
620-355	Detach. Bar., w/mess 20' x var.	1918	Manual Cnstr Div		9 a2
620-356	Administration Building, 20'x49'	1918	Manual Cnstr Div		1 c
620-359	Post Exchange, 32x91	1918	Manual Cnstr Div		7 f
620-361 & 362	Bakery, 40'x136 & 51'x62'	1918	Manual Cnstr Div		5 c1
620-363	Officers Quarters, 20xvar.	1918	Manual Cnstr Div		9 c2
620-364	Officers Quarters, 20xvar.	1918	Manual Cnstr Div		9 c2
620-365	Fire Station, 31'x88'	1918	Manual Cnstr Div		1 a
620-366	Barrack, 30'x40'	1918	Manual Cnstr Div		9 a2
620-368 to 375	Infirmary - Medical, 30'x77'	1918	Manual Cnstr Div		4 a
620-369	Officer's Qtrs, 20x21 types A,B,C	1918	Manual Cnstr Div		9 c2
620-370	Magazine, 20'x20'	1918	Manual Cnstr Div		5 d2
620-371	Magazine, 24'x60'	1918	Manual Cnstr Div		5 d2
620-372	Shop, 20x36	1918	Manual Cnstr Div		5 a
620-373	Prisoner's Barrack & Yard, 30'x9	1918	Manual Cnstr Div		9 a2
620-373-A	Guard Barrack, 30'x90'	1918	Manual Cnstr Div		9 a2
620-374	Post Office Building, 32x51	1918	Manual Cnstr Div		1 d
620-376	Stable - open 24xvar.	1918	Manual Cnstr Div		10 b1
620-378	Hay Shed, 60'x165'	1918	Manual Cnstr Div		10 b1
620-379	Bakery, 40'x136'	1918	Manual Cnstr Div		5 c1
620-381	Shop, Clothing etc 30x102	1918	Manual Cnstr Div		5 a
620-382	Infirmary - Medical, 30'x105'	1918	Manual Cnstr Div		4 a
620-383 & 384	Infirmary - Medical, 30'x112'	1918	Manual Cnstr Div		4 a
620-385 & 386	Warehouse, Clothing, 60x100	1918	Manual Cnstr Div		5 d1
620-387 & 388	Shop, Motor Repair, 60x130	1918	Manual Cnstr Div		10 c2
620-390	Shop, QMaster, 2 bldgs each, 36x106	1918	Manual Cnstr Div		5 a
620-392 & 393	Infirmary - Medical, 30'x98'	1918	Manual Cnstr Div		4 a
620-395	Stable Guard , 20x21	1918	Manual Cnstr Div		5 a
620-396	Oil house, 20x30	1918	Manual Cnstr Div		6 a
620-397	Auto & Mtr Serv Sta, 35'x41'	1918	Manual Cnstr Div		10 c1
620-412 & 413	Store House, Salvage, 60x168	1918	Manual Cnstr Div		5 d1
620-418	Telegraph office & Quarters, 20x110	1918	Manual Cnstr Div		2 b
620-428	Bakery, 30'x50'	1918	Manual Cnstr Div		5 c1
620-429	Meat Inspection Platform, 10'x66'	1918	Manual Cnstr Div		9 b2
620-432	Waste & Transfer Station, 20x130	1918	Manual Cnstr Div		6 c
620-435	Rendering Plant, 32x48	1918	Manual Cnstr Div		5 b

Sorted by: STANDARDIZED PLAN NUMBER

STD_PLAN	BUILDING	DATE	INSTALLATION	DRWNG	TYPE
620-436	Shop, Cot repair, 40x36	1918	Manual Cnstr Div		5 a
620-437	Shop, Clothing, etc, 60x100	1918	Manual Cnstr Div		5 a
620-439	Shop, Tent Treating, 36x40	1918	Manual Cnstr Div		5 a
620-440	Shop, Tent Repair, 40x60	1918	Manual Cnstr Div		5 a
620-441	Fire Station, 31'x88'	1918	Manual Cnstr Div		1 a
620-442	Mess Building, 30x120 , x132, x144	1918	Manual Cnstr Div		9 b2
620-445 & 446	Hose House (Type A & B) 6'x7'	1918	Manual Cnstr Div		6 b
620-447	Fire Station, 31'x103	1918	Manual Cnstr Div		1 a
620-449	Infirmery - Medical, 30'x56'	1918	Manual Cnstr Div		4 a
620-450	Classroom Building, 30' x 60'	1918	Manual Cnstr Div		3 a
620-451	Shower shelter & wash house, 20x80	1918	Manual Cnstr Div		9 b1
620-452	Magazine, brick w/corr steel rf, 10	1918	Manual Cnstr Div		5 d2
620-457 & 458	Barrack & lavatory, 43'x120'	1918	Manual Cnstr Div		9 a2
620-467	Shop, Clothing, etc 28x132, 28x162	1918	Manual Cnstr Div		5 a
620-469 & 470	Classroom Building, 49'x150	1918	Manual Cnstr Div		3 a
620-471 & 472	Refrigeration Plant, 20x72	1918	Manual Cnstr Div		9 b2
620-473	Regrigeration Cooling Tower,	1918	Manual Cnstr Div		9 b2
620-478 & 479	Shop, Motor Repair, 75x96	1918	Manual Cnstr Div		10 c2
620-490 & 491	Coffee Roasting & Grinding Plant	1918	Manual Cnstr Div		5 b
620-492	Boiler Houses	1918	Manual Cnstr Div		6 a
620-496	Garage for Ambulances, 22'x47'	1918	Manual Cnstr Div		4 b
620-499 & 500	Liberty Theatre, 60x120	1918	Manual Cnstr Div		7 g
620-505	Bakery 33'x51'	1918	Manual Cnstr Div		5 c1
620-507	Classroom Building, 30'x60'	1918	Manual Cnstr Div		3 a
620-508	Ordnance Repair Shop 30x106	1918	Manual Cnstr Div		5 a
620-511	Garage, 30' x var.	1918	Manual Cnstr Div		9 d1
620-523	Lavatory w/showers, 20x50	1918	Manual Cnstr Div		9 b1
620-524	Garage, open, 50'xvar.	1918	Manual Cnstr Div		9 d1
620-525	Garage, closed, 70'x180'	1918	Manual Cnstr Div		9 d1
6209-113	Cafeteria, 105x192	1918	Manual Cnstr Div		9 b2
621-1072	Barracks	1938	Marshall Field,	X	9 a2
621-1325--1346	Med Dtchmnt Bar (and 6560-140--142)	1939	F.E. Warren AFB		9 a2
621-850 & 851	Detachment Barracks	1931	F.E. Warren AFB		9 a2
6217-105 to 107	War Dept Theatre, 85x49	1939	Fort McPherson		7 g
6217-127?	Film Vault, size illegible	?	Fort McPherson		5 d1
6217-36 to 45	Clinic 28 beds, 34x130, 9x30	1930	Fort McPherson		5 d1
6217-47 to 57	Kitchen & Mess, 24x100, 31x33	1930	Fort McPherson		9 b2
6217-65, 74, 76	Dental Cinc & Cont. Ward, 34x130	1939	Fort McPherson		4 a
6242-5	Garage, Mechanical Repair, 140x144	1918	Manual Cnstr Div		9 d1
625-1301	Field Officers Quarters	1932	Marshall Field,	X	9 c2
625-1340	Field Officers Quarters	1933	Marshall Field,	X	9 c2
625-1341	Field Officers Quarters	1932	Fort Riley, KS	X	9 c2
625-1444	Double NCO Quarters, 2 sty, brick	1930	Fort Riley, KS		9 c1
625-1486 & 87	Company Officer's Quarters	1932	F.E. Warren AFB		9 c2
625-1486 & 1487	Company Officrs Qtrs	N.D.	Fort D.A. Russel		9 c2
625-1530	Double NCO Quarters 2 sty, brick	1930	Fort Riley, KS	X	9 c1
625-1543	Double NCO Quarters, w sty, brick	1930	Fort Riley, KS		9 c1
625-1543 & 1544	Double NCO Quarters	1931	Fort D.A. Russel		9 c1
625-1556	NCO Quarters - type c - brick	1932	Fort Riley, KS	X	9 c1
625-2491	Company Officers Quarters	1932	Marshall Field,	X	9 c2
625-2510 & 2511	Double NCO Quarters	1933	Fort D.A. Russel		9 c1

Sorted by: STANDARDIZED PLAN NUMBER

STD_PLAN	BUILDING	DATE	INSTALLATION	DRWNG	TYPE
625-2510 & 2518	Double NCO Quarters, type B	1933	F.E. Warren AFB		9 c1
625-2510 - 2511	Double NCO Quarters, type A	1933	F.E. Warren AFB		9 c1
625-3570-3	Double NCO Quarters, 2 sty, stone	1938	Fort Riley, KS	X	9 c1
625-3571	Double NCO Quarters, 2 sty, brick	1935	Fort Riley, KS	X	9 c1
625-3571-3	Double NCO Quarters, 2 story, stone	1938	Fort Riley, KS	X	9 c1
625-3572	Double NCO Quarters, 2 sty, brick	1935	Fort Riley, KS	X	9 c1
625-3572-3	Double NCO Quarters, 2 story stone	1938	Fort Riley, KS	X	9 c1
625-541	NCO Double Quarters	1930	Fort Riley, KS	X	9 c1
625-803	4 Family Apt. House, Company Ofcrs	1928	Fort Riley, KS		9 c2
625-806	4 Family Apt. House, Company Ofcrs	1930	Fort Riley, KS	X	9 c2
625-808	Four Family Apartment House	1930	Fort Riley, KS	X	9 c2
6271-7	Storage Depot/admin Bldg, 140x160	1918	Manual Cnstr Div		5 d1
630-100	Typ L'scp Pl'tg: CO & Dbl CO Qtrs	1935	Office of QMG	X	11 a
630-102	Typical Street Tree Planting	1935	Office of QMG	X	11 a
630-103	Typ L'scp Pl'tg: Th'tre, Hosp, Chpl	1935	Office of QMG	X	11 a
630-Illegible	Typ. L'scp Pl'tg: HQ, Admin, BOQ	1935	Office of QMG	X	11 a
6307-110	Dormitory for men, 28x113	1918	Manual Cnstr Div		9 a2
6309-121	Housing, 4 families, 38x53	1918	Manual Cnstr Div		9 c1
6309-150	Housing, 1 family, 24x30	1918	Manual Cnstr Div		9 c1
6309-160	Housing, Boarding, 27x38	1918	Manual Cnstr Div		9 c1
6309-180	Housing, 1 family, 24x36	1918	Manual Cnstr Div		9 c1
6309-190	Housing, 1 family, 24x32	1918	Manual Cnstr Div		9 c1
6309-200	Housing, 2 family, 25x36	1918	Manual Cnstr Div		9 c1
6311-105	Garage, 61x164	1918	Manual Cnstr Div		9 d1
632-551	Delousing Plant, 48x84	1918	Manual Cnstr Div		4 a
632-552	Delousing Plant, 60x204	1918	Manual Cnstr Div		4 a
633-130	Laundry, 72x216, 5-10,000 men	1918	Manual Cnstr Div		5 c2
633-140	Laundry, 36x108, 1-2,000 men	1918	Manual Cnstr Div		5 c2
633-165	Typical Dry Cleaning Plant	1930	Fort Riley, KS		5 c2
6339-111	Dormitory & Dining Room, 29x136	1918	Manual Cnstr Div		9 a2
6339-131	Cafeteria, 54x189	1918	Manual Cnstr Div		9 b2
6342-158 ?	Standard All Steel Airplane Hangar	?	Chief of Air Ser	X	10 a1
6370-106	Cafeteria, 132x173	1918	Manual Cnstr Div		9 b2
6383-110	Cafeteria, 110x171	1918	Manual Cnstr Div		9 b2
6399-120	Welfare Bldg, 84x96	1918	Manual Cnstr Div		1 c
64-B	Band Stand, Cavalry & Artillery	1911	F.E. Warren AFB		7 g
6403-111	Cafeteria, 156x200	1918	Manual Cnstr Div		9 b2
642-535	Magazines igloo type	1916	Fort Chaffee		5 d2
652-146	Magazine, Smokeless pwdr, 32x96	1918	Manual Cnstr Div		5 d2
652-152	Pyrotech Plant Type D, 20x35	1918	Manual Cnstr Div		5 b
652-157	Pyrotech Plant Type 1 & 2, 30x161	1918	Manual Cnstr Div		5 b
652-158	Pyrotech Plant Type J & J1, 20x35	1918	Manual Cnstr Div		5 b
652-165	Shed, Dock, 60x122	1918	Manual Cnstr Div		5 d2
652-169	Magazine, Type 13, 26x42	1918	Manual Cnstr Div		5 d2
652-17	Garage, Ordinance, 50xvar.	1918	Manual Cnstr Div		9 d1
652-173	Primer & Fuse house #1, 32x96	1918	Manual Cnstr Div		5 d2
652-174	Primer & Fuse house #2, 32x96	1918	Manual Cnstr Div		5 d2
652-179	Magazine, Type 10, 49x208	1918	Manual Cnstr Div		5 d2
652-180	Magazine, Type 11, H.E. 26x42	1918	Manual Cnstr Div		5 d2
652-188	Storage, Vehicles # 3, 161xvar	1918	Manual Cnstr Div		10 c
652-19	Shop, Ordinance Repair, 30x80	1918	Manual Cnstr Div		5 a

Sorted by: STANDARDIZED PLAN NUMBER

STD_PLAN	BUILDING	DATE	INSTALLATION	DRWNG	TYPE
652-214	Guard House, Type 1, 20x56	1918	Manual Cnstr Div		1 b
652-31	Magazine, Type 12, 26x42	1918	Manual Cnstr Div		5 d2
652-41	Storehouse, General, #1, 161x501	1918	Manual Cnstr Div		5 d1
652-419	Ordnance Shop w/crane	1916	Fort Chaffee		5 a
652-423	Ordnance Shop Boiler House	1916	Fort Chaffee		5 a
652-43	Storage, Vehicles, #1, 113x513	1918	Manual Cnstr Div		10 c2
652-535	Magazines igloo type	1916	Fort Chaffee		5 d2
652-74	Storehouse, General, #2	1918	Manual Cnstr Div		5 d1
652-81	Transformer Sta. Type 1, 20x36	1918	Manual Cnstr Div		6 a
6560-140 - 142	Med. Detachment Barracks	1939	Fort D.A. Russel		9 a2
6560-140--142	Medical Detachment Bar	1939	F.E. Warren AFB		9 a2
6560-145 - 179	Gymnasium	1940	Fort D.A. Russel		7 b
67-B	Coal Shed	1904	F.E. Warren AFB		5 d1
67-J	Coal Shed	1909	F.E. Warren AFB		5 d1
68-C	Water Tank (tower)	1903	F.E. Warren AFB		6 b
695-272	Air Corps Hangar	1930	Chief of Air Cor	X	10 a1
695-284	Air Corps Hangar, E Design	1931	Chief of Air Cor	X	10 a1
700-1127	Officers Mess	1916	Fort Chaffee		9 b2
700-1204	Med. Detachment Barracks	1916	Fort Chaffee		9 a2
700-1212.1	Theatre w/Stage	1916	Fort Chaffee		7 g
700-1240	Nurses' Quarters	1916	Fort Chaffee		9 a1
700-1254	Officers' Quarters	1916	Fort Chaffee		9 c2
700-1257	Officers' Quarters	1916	Fort Chaffee		9 c2
700-1265R	Cold Storage	1916	Fort Chaffee		5 d1
700-1290	Guest House	1916	Fort Chaffee		9 a1
700-1390	Motor Repair Shop	1916	Fort Chaffee		10 c2
700-1800	Chapel	1916	Fort Chaffee		7 c
700-260	Unit Guardhouse	1916	Fort Chaffee		1 b
700-260.1	Unit Guardhouse	1916	Fort Chaffee		1 b
700-279	Infirmary - Large	1940	Fort Riley, KS		4 a
700-285	Lavatory	1916	Fort Chaffee		9 b1
700-297	Exchange	1916	Fort Chaffee		7 f
700-298	Post Office, Type PO-1	1937	Fort Riley, KS	X	1 d
700-310	Recreational Bldg.	1916	Fort Chaffee		7 a
700-317	Shop - Utilities	1937	Fort Riley, KS	X	5 a
700-323	Oil House 25x 49'	1916	Fort Chaffee		6 a
700-348	Physiotherapy	1916	Fort Chaffee		4 b
700-374	Motor School	1916	Fort Chaffee		10 c2
700-384	Oil Shed	1916	Fort Chaffee		6 a
700-44+A476	Mess Patients	1916	Fort Chaffee		9 b2
700-446	Medical Detachment Mess	1916	Fort Chaffee		9 b2
700-450	Officers' Mess	1916	Fort Chaffee		9 b2
700-451	Nurses' Mess	1916	Fort Chaffee		9 b2
700-461	Storehouse	1916	Fort Chaffee		5 d1
700-462	X-Ray Building	1916	Fort Chaffee		4 b
700-463	Ward Combination	1916	Fort Chaffee		4 b
700-467	Dental Clinic	1916	Fort Chaffee		4 a
700-476	Clinic	1916	Fort Chaffee		4 a
700-484	Clinic	1916	Fort Chaffee		4 a
700-520	Recreation Bldg. Patients	1916	Fort Chaffee		4 b

Sorted by: STANDARDIZED PLAN NUMBER

STD_PLAN	BUILDING	DATE	INSTALLATION	DRWNG	TYPE
702-118	Paint Oil & Dope House	1940	Marshall Field,	X	5 d1
707-102 to 107	Nurses Quarters, 13 nurses	1933	Fort McPherson		9 a
7093-451	Fld. Office	1916	Fort Chaffee		1 c
7093-454.2	Fld. Office Water Stg. Tank	1916	Fort Chaffee		5 d1
7093-501	Heating Plant	1916	Fort Chaffee		6 a
7093-921	152 Man Mess	1916	Fort Chaffee		9 b2
75	Cavalry Barracks	1902	Fort Riley, KS	X	9 a2
75-G	Double barracks, 39x150	1904	Fort McPherson		9 a2
75-M	Cavalry Barracks	1910	F.E. Warren AFB		9 a2
700+A42-374	Motor Repair Shop	1916	Fort Chaffee		10 c2
700-1775	Service Club	1916	Fort Chaffee		7 d
800-1000	C & E Repair Shop	1916	Fort Chaffee		5 a
800-1026	Grease Rack & Insp. Rack	1916	Fort Chaffee		10 c2
800-1029	Laundry	1916	Fort Chaffee		5 c2
800-1226	Cold Storage Bldg	?	Fort Riley, KS	X	5 d1
800-1412	Post Exchange	1916	Fort Chaffee		7 f
800-1417	Administration Bldg. (Hosp.)	1916	Fort Chaffee		1 c
800-1429	Infirmary	1916	Fort Chaffee		4 a
800-1445	Dental Clinic	1916	Fort Chaffee		4 a
800-1454	Morgue	1916	Fort Chaffee		4 b
800-1513	Clinic	1916	Fort Chaffee		4 a
800-1619	Laundry Steam Plant	1916	Fort Chaffee		5 c2
800-201	Station QM Office Boiler Hs.	1916	Fort Chaffee		6 a
800-204	Administration Bldg.	1916	Fort Chaffee		1 c
800-210	Armament	1916	Fort Chaffee		5 d
800-214	Sta. HQ. Office	1916	Fort Chaffee		1 c
800-217	Post Office	1916	Fort Chaffee		1 d
800-219	Sm Finance. Bldg.	1916	Fort Chaffee		1 c
800-306	Officers Quarters	1916	Fort Chaffee		9 c2
800-307	Officers' Quarters	1916	Fort Chaffee		9 c2
800-443	Prisoner's Barracks	1916	Fort Chaffee		9 a2
800-451	Nurses Recreation Room	1916	Fort Chaffee		7 a
800-459	Med. Detachment Recr.	1916	Fort Chaffee		7 a
800-460	Recreation Bldg.	1916	Fort Chaffee		7 a
800-465	Sports Arena	1916	Fort Chaffee		7 b
800-601	Gas Sta. & Pump House	1916	Fort Chaffee		10 c1
800-603	Q.M. Utility Shop	1916	Fort Chaffee		5 a
800-606	Motor Repair Shop	1916	Fort Chaffee		10 c2
800-607	Rm. & Storage Bays	1916	Fort Chaffee		5 d1
800-652	Salvage Warehouse	1916	Fort Chaffee		5 d1
800-654	Warehouse (Insulated)	1916	Fort Chaffee		5 d1
800-661	Dispatching House	1916	Fort Chaffee		10 c2
800-663	Storehouse	1916	Fort Chaffee		5 d1
800-664	Storehouse	1916	Fort Chaffee		5 d1
800-682	Bakery	1916	Fort Chaffee		5 c1
800-777	Ice Storage	1916	Fort Chaffee		5 d1
800-800	Fire Station	1916	Fort Chaffee		1 a
800-809	Officers' Club	1916	Fort Chaffee		7 d
800-847	112 Man Mess	1916	Fort Chaffee		9 b2
800-849	E.M. Mess	1916	Fort Chaffee		9 b2

Sorted by: STANDARDIZED PLAN NUMBER

STD_PLAN	BUILDING	DATE	INSTALLATION	DRWNG	TYPE
800-851	E.M. Mess (M-248 less one 8'bay)	1916	Fort Chaffee		9 b2
800-905	Radio Range Bldg.	1916	Fort Chaffee		2 a
800-907	Tel. & Tel Bldg.	1916	Fort Chaffee		2 b
800-A101210	Med. Detachment Admin. Bldg.	1916	Fort Chaffee		1 c
800.-1424	Detention Ward	1916	Fort Chaffee		4 b
82-D	Double Set N.C.S.O. Quarters	1885	F.E. Warren AFB		9 c1
82-K	N.C.O. Quarters	1909	F.E. Warren AFB		9 c1
82-N	Four Set Civillian's Quarters	1909	Fort Riley, KS	X	9 c1
82-P	Civillian Employees Quarters	1911	F.E. Warren AFB		9 c1
8682-D	Double NCO Quarters	1931	F.E. Warren AFB		9 c1
9	Guard House, 60x85	1891	Fort McPherson		1 b
90	Double Set Officer's Quarters	1905	F.E. Warren AFB		9 c2
93-K	Dbl Mess Hall & Kit, 140x42,	1906	Fort McPherson		9 b2
95-A	C.O.'s Quarters	1903	F.E. Warren AFB		9 c2
97-A	Cavalry Drill Hall	1907	F.E. Warren AFB		3 b
98-E	Fire Station	1909	F.E. Warren AFB		1 a
98-G	Fire Station	1909	F.E. Warren AFB		1 a
A-13-1	Incinerator	1938	Fort Riley, KS		6 c
A-13-9	Artillery Guard House	1908	Fort Riley, KS	X	1 b
A-14-12	Stable - School of Equitation	1939	Fort Riley, KS	X	10 b1
A-14-16	Lab Building for Vet Hosp	1907	Fort Riley, KS	X	8 a
A-14-4	Stable	1938	Fort Riley, KS		10 b1
A-19-1	Commissary Store House	1905	Fort Riley, KS	X	5 d1
A-19-14	Barracks	1938	Fort Riley, KS		9 a2
A-19-4	Dispatcher's Office	1939	Fort Riley, KS		10 c2
A-2-17	Quarters for Packers	N.D.	Fort Riley, KS	X	9 a2
A-2-3	Quarters, no designation	1939	Fort Riley, KS	X	9 c1
A-20-12	Revised Plan of Engineer Garage	1937	Fort Riley, KS	X	9 d1
A-20-7	NCO Garages	1940	Fort Riley, KS	X	9 d1
A-4-7	Quarters, no designation	1939	Fort Riley, KS	X	9 c2
A-4-9	Quarters, no designation	1938	Fort Riley, KS	X	9 c2
A-5-21	Q.M. Gas Station	1932	Fort Riley, KS	X	10 c1
A-8-12	Packing & Crating shop	1938	Fort Riley, KS	X	5 a
Butler Mfg Co	Airplane Hangar	N.D.	Fort Riley, KS	X	10 a1
E.B. Williston	Battery Stables	N.D.	Fort Riley, KS	X	10 b1
Geo. E. Pond	Administration Building	N.D.	Fort Riley, KS		1 c
Geo. E. Pond	Proposed Administration Building	N.D.	Fort Riley, KS		1 c
Geo. E. Pond	Cavalry Stables	N.D.	Fort Riley, KS	X	10 b1
Geo. E. Pond	Dispensary	N.D.	Fort Riley, KS	X	4 a
Geo. E. Pond	Battery Workshops	N.D.	Fort Riley, KS	X	5 a
Geo. E. Pond	Ordnance Store House	N.D.	Fort Riley, KS	X	5 d2
Geo. E. Pond	Post Exchange & Gymnasium	N.D.	Fort Riley, KS	X	7 a
Geo. E. Pond	Artillery Barracks, 80 Men	1896	Fort Riley, KS	X	9 a2
Geo. E. Pond	Cavalry Barracks	N.D.	Fort Riley, KS	X	9 a2
Geo. E. Pond	Outhouse for Cavalry Barracks	N.D.	Fort Riley, KS	X	9 b1

Sorted by: STANDARDIZED PLAN NUMBER

STD_PLAN	BUILDING	DATE	INSTALLATION	DRWNG	TYPE
Geo. E. Pond	Frame Quarters for NCO	1928	Fort Riley, KS	X	9 c1
Geo. E. Pond	Non-Commissioned Officers Quarters	N.D.	Fort Riley, KS	X	9 c1
Geo. E. Pond	Quarters for Steam Heating Engineer	N.D.	Fort Riley, KS	X	9 c1
Geo. E. Pond	Proposed Field Officers Quarters	N.D.	Fort Riley, KS	X	9 c2
Geo. E. Pond	Quarters for Commanding Officer	N.D.	Fort Riley, KS	X	9 c2
George Ruhlen	Cavalry Stable Guard Building	1896	Fort Riley, KS	X	1 b
I-620-B	Crematory	1908	Fort D.A. Russel		6 c
LA-1	Road Cross Section, Typical	1918	Manual Cnstr Div	X	10c2
LA-2	Road Cross Sections, Typical	1918	Manual Cnstr Div	X	10c2
Post	Hose House, 30x50	1898	Fort McPherson		6 b
RR 9	Trestle, Coal	1918	Fort Lewis, WA	X	10 d1
RR-1	Standard Railway Trestle	1918	Manual Cnstr Div	X	10 d1
RR-2	Std. Railway Coal Trestle	1918	Manual Cnstr Div	X	10 d1
RR-3	Std. Timber Coal Pocket	1918	Manual Cnstr Div	X	10 d1
RR-4	Turnout & Crossover, Railways	1918	Manual Cnstr Div	X	10 d2
RR-5	Std. Trestle Bumper, Railways	1918	Manual Cnstr Div	X	10 d1
RR-6	Roadbed Sectons, Railways	1918	Manual Cnstr Div	X	10 d2
RR-7	Terminal General Plan	1918	Manual Cnstr Div	X	11a
RR-8	Terminals General Plans	1918	Manual Cnstr Div	X	11a
SB 1	Typical 1 Story Building	1918	Manual Cnstr Div	X	11a
SB 10	Typ Em'gncy Str'g Whse Toilet Rms	1918	Manual Cnstr Div	X	5 d1
SB 11	Elec Distrib Syst, Street Lighting	1918	Manual Cnstr Div	X	6a
SB 12	Elec Distrib Syst, 2ndary Lines	1918	Manual Cnstr Div	X	6a
SB 13	Typ Hospital Kitchen Layouts	1918	Manual Cnstr Div	X	9 b2
SB 14	Hospital Typ Kitchen Layouts	1918	Manual Cnstr Div	X	4 b
SB 15	Typical Mess Buildings	1918	Manual Cnstr Div	X	9 b2
SB 16	Store House, Divisional, 60x168	1918	Manual Cnstr Div	X	5 d1
SB 17	Stable - closed, 29xvar.	1918	Manual Cnstr Div	X	10 b1
SB 18	Det Hut & Kitchen, Det & Qrntn Camp	1918	Manual Cnstr Div	X	9 b2
SB 19	Recruit Exam. Bldg / Shop	1918	Manual Cnstr Div	X	4 a
SB 2	Typical 2 Story Building	1918	Manual Cnstr Div	X	11a
SB 20	Standard Laundry, 10-20,000 men	1918	Manual Cnstr Div		5 c2
SB 21	Delousing Plant, 54x120	1918	Manual Cnstr Div	X	4 a
SB 22	Dormitories w/Mess	1918	Manual Cnstr Div	X	9 a2
SB 23	Magazine, Type 1 & Type 2	1918	Manual Cnstr Div	X	5 d2
SB 24	Auditorium, 200x300	1918	Manual Cnstr Div	X	7 a
SB 25	Em'gncy Whse C'prtmt & Group Plan	1918	Manual Cnstr Div	X	5 d1
SB 26	Typ. Em'gncy Str'g Whse Admin Bldg	1918	Manual Cnstr Div	X	5 d1
SB 27	Em'gncy Whse, Open Shed	1918	Manual Cnstr Div	X	5 d1
SB 28	Refrigerating & Ice Making Plant	1918	Manual Cnstr Div	X	5 b
SB 3	Typical 2 Sty Building, Details	1918	Manual Cnstr Div	X	11a
SB 4	Typical Barracks, 66 Men	1918	Manual Cnstr Div	X	9 a2
SB 5	Typical 2 Story Officers Qtrs	1918	Manual Cnstr Div	X	9 c2
SB 6	Typical Lavatories	1918	Manual Cnstr Div	X	9 b1
SB 7	Typical Lavatories Details	1918	Manual Cnstr Div	X	9 b1

Sorted by: STANDARDIZED PLAN NUMBER

STD_PLAN	BUILDING	DATE	INSTALLATION	DRWNG	TYPE
SB 8	Standard Incinerator	1918	Manual Cnstr Div	X	6 c
SB 9	Standard Steel & Wood Hangars	1919	Manual Cnstr Div	X	10 a1
SGO-A	Layout: Hospital	1918	Manual Cnstr Div	X	4 b
SGO-A1	Layout: Head House	1918	Manual Cnstr Div	X	4 b
SGO-B	Typical Hosp Admin Bldg	1918	Manual Cnstr Div	X	4 b
SGO-F	Typical Hosp Laboratory Bldg	1918	Manual Cnstr Div	X	4 b
SGO-G	Typical Hosp Operating Pavillion	1918	Manual Cnstr Div	X	4 b
SGO-I1 & I32	Typical Hosp General Mess & Kitchen	1918	Manual Cnstr Div	X	4 b
SGO-I28	Typical Hosp General Mess & Kitchen	1918	Manual Cnstr Div	X	4 b
SGO-J	Typical Hosp Receiving Ward	1918	Manual Cnstr Div	X	4 b
SGO-K1	Typical Hosp Single Wards	1918	Manual Cnstr Div	X	4 b
SGO-K34	Typical Hosp Single Wards	1918	Manual Cnstr Div	X	4 b
SGO-K35	Typical Hosp Single Wards	1918	Manual Cnstr Div	X	4 b
SGO-S & T	Typ. Hosp Phys Thrpy & Amusmnt Hall	1918	Manual Cnstr Div	X	4 b
SPL 3-368	Double Quarters for Officer	1902	Fort Riley, KS	X	9 c2
SPL 3-381	Officers Quarters	1902	Fort Riley, KS		9 c2
Unknown	Hospital Sergant's Quarters	1905	F.E. Warren AFB		9 c1

Sorted by: INSTALLATION

INSTALLATION	BUILDING	DATE	STD_PLAN	DRWNG	TYPE
Chief of Air Cor	Air Corps Hangar	1930	695-272	X	10
Chief of Air Cor	Air Corps Hangar, E Design	1931	695-284	X	10 a1
Chief of Air Ser	Standard All Steel Airplane Hangar	?	6342-158 ?	X	10 a1
F.E. Warren AFB	Officers Quarters	1888	(Illegible)2		9 c2
F.E. Warren AFB	Post Bakery	1903	1-1180		5 c1
F.E. Warren AFB	Crematory	1908	1-620-B		6 c
F.E. Warren AFB	Post Headquarters	1909	1-729 S.P.S.		1 c
F.E. Warren AFB	Hay Shed	1926	102-F		10 b1
F.E. Warren AFB	Hay Shed	1909	102-G		10 b1
F.E. Warren AFB	Light Battery Gun Shed	1905	104		5 d2
F.E. Warren AFB	Light Battery Gun Shed	1908	104-F		5 d2
F.E. Warren AFB	Administration Building	1911	112-F		1 c
F.E. Warren AFB	Double Set Officer's Quarters	1905	120-C		9 c2
F.E. Warren AFB	Double Set Officers Quarters	1905	120-D		9 c2
F.E. Warren AFB	Double Lieutenants Quarters	1909	120-F		9 c2
F.E. Warren AFB	Officers Quarters	1910	120-H		9 c2
F.E. Warren AFB	Artillery Exchange	1910	122-B		7 f
F.E. Warren AFB	Cavalry Post Exchange	1910	122-b		7 f
F.E. Warren AFB	Admin Building (Artillery)	1911	122-F		1 c
F.E. Warren AFB	Company Ofcr 4 Set Apt	1931	129		9 c2
F.E. Warren AFB	Pump House (& N.C.O. Quarters)	1905	132-E		6 b
F.E. Warren AFB	Cavalry Stable	1906	139		10 b1
F.E. Warren AFB	Artillery Stables	1904	139-C		10
F.E. Warren AFB	Artillery or Infantry Stables	1908	139-K		10 b1
F.E. Warren AFB	Stable for Inf. & Officers Mounts	1908	139-Q		10 b1
F.E. Warren AFB	Double Officers Quarters	1906	142-A		9 c2
F.E. Warren AFB	Double Officers Quarters	1909	142-B		9 c2
F.E. Warren AFB	Officers Quarters	1910	142-D		9 c2
F.E. Warren AFB	Field Officers Quarters	1905	145		9 c2
F.E. Warren AFB	Field Officers Quarters	1909	145-D		9 c2
F.E. Warren AFB	Field Officers Quarters	1910	145-F		9 c2
F.E. Warren AFB	Artillery Barracks	1904	150		9 a2
F.E. Warren AFB	Nurses Quarters	1906	152-E		9 a1
F.E. Warren AFB	Bachelor Officers Quarters	1908	152-G		9 a1
F.E. Warren AFB	Bachelor Officers Quarters	1910	152-L		9 a1
F.E. Warren AFB	Post Exchange	1905	158		7 f
F.E. Warren AFB	Veterinary Hospital	1908	166		10 b1
F.E. Warren AFB	Post & Telegraph Office	1907	177		1 d
F.E. Warren AFB	Artillery Barracks	1908	181		9 a2
F.E. Warren AFB	Commissary Building	1910	186		7 f
F.E. Warren AFB	Cavalry Granary	1909	193-A		5 d1
F.E. Warren AFB	Ice House	1910	196-A		6 b
F.E. Warren AFB	Q.M. Store House, Artillery	1909	198		5 d2
F.E. Warren AFB	Guard House	1911	206		1 b
F.E. Warren AFB	Artillery Gun Shed	1909	209		5 d2
F.E. Warren AFB	Laundry	1911	234-B		5 c2
F.E. Warren AFB	Field Officers Quarters	1911	235-A		9 c2
F.E. Warren AFB	4 Set Officers Quarters	1911	237-B		9 c2
F.E. Warren AFB	Laundry	1911	243-B		5 c2

Sorted by: INSTALLATION

INSTALLATION	BUILDING	DATE	STD_PLAN	DRWNG	TYPE
F.E. Warren AFB	Dispensary (Cavalry)	1909	247		4 a
F.E. Warren AFB	Teamsters Quarters	1910	258		9 a2
F.E. Warren AFB	Ammunition Storehouse	1910	262		5 d2
F.E. Warren AFB	Powder Magazine	1910	263		5 d2
F.E. Warren AFB	Hospital Corps Barracks	1912	276		9 a2
F.E. Warren AFB	Post Guard House	1901	30-C		1 b
F.E. Warren AFB	Stable Guard House, DBL Building	1905	39-C	X	10 b1
F.E. Warren AFB	Stable Guard House & Shops	1909	39-G		10 b1
F.E. Warren AFB	Stable Guard House	1909	39-L		10 b1
F.E. Warren AFB	Stable Guard & Shops	1909	39-N		10 b1
F.E. Warren AFB	Stable Guard & shops	1911	39-Q		10 b1
F.E. Warren AFB	Incinerator - trash only	1939	414-43-228		6 c
F.E. Warren AFB	Q.M. Forage Storehouse	1908	53-A		5 d1
F.E. Warren AFB	Q.M. Barracks for M.T.	1900	53-D		9 a2
F.E. Warren AFB	Artillery Workshop	1904	59-K		5 a
F.E. Warren AFB	Utility Office	1931	59-U		6 b
F.E. Warren AFB	Artillery Shop	1908	59-V		5 a
F.E. Warren AFB	Wagon Shed	1906	60-G		10 b1
F.E. Warren AFB	Vehicle Shed	1910	60-H		10 c2
F.E. Warren AFB	War Dept Theatre	1939	608-360 to 366		7 g
F.E. Warren AFB	Cavalry Band Barracks	1909	61-F		9 a2
F.E. Warren AFB	Med Dctmnt Bar (and 6560-140--142)	1939	621-1325--1346		9 a2
F.E. Warren AFB	Detachment Barracks	1931	621-850 & 851		9 a2
F.E. Warren AFB	Company Officer's Quarters	1932	625-1486 & 87		9 c2
F.E. Warren AFB	Double NCO Quarters, type B	1933	625-2510 & 2518		9 c1
F.E. Warren AFB	Double NCO Quarters, type A	1933	625-2510 - 2511		9 c1
F.E. Warren AFB	Band Stand, Cavalry & Artillery	1911	64-B		7 g
F.E. Warren AFB	Medical Detachment Bar	1939	6560-140--142		9 a2
F.E. Warren AFB	Coal Shed	1904	67-B		5 d1
F.E. Warren AFB	Coal Shed	1909	67-J		5 d1
F.E. Warren AFB	Water Tank (tower)	1903	68-C		6 b
F.E. Warren AFB	Cavalry Barracks	1910	75-M		9 a2
F.E. Warren AFB	Double Set N.C.S.O. Quarters	1885	82-D		9 c1
F.E. Warren AFB	N.C.O. Quarters	1909	82-K		9 c1
F.E. Warren AFB	Civillian Employees Quarters	1911	82-P		9 c1
F.E. Warren AFB	Double NCO Quarters	1931	8682-D		9 c1
F.E. Warren AFB	Double Set Officer's Quarters	1905	90		9 c2
F.E. Warren AFB	C.O.'s Quarters	1903	95-A		9 c2
F.E. Warren AFB	Cavalry Drill Hall	1907	97-A		3 b
F.E. Warren AFB	Fire Station	1909	98-E		1 a
F.E. Warren AFB	Fire Station	1909	98-G		1 a
F.E. Warren AFB	Hospital Sergeant's Quarters	1905	Unknown		9 c1
Fort Chaffee	Incinerator	1916	414/43/330		6 c
Fort Chaffee	Magazines igloo type	1916	642-535		5 d2
Fort Chaffee	Ordnance Shop w/crane	1916	652-419		5 a
Fort Chaffee	Ordnance Shop Boiler House	1916	652-423		5 a
Fort Chaffee	Magazines igloo type	1916	652-535		5 d2
Fort Chaffee	Officers Mess	1916	700-1127		9 b2
Fort Chaffee	Med. Detachment Barracks	1916	700-1204		9 a2
Fort Chaffee	Theatre w/Stage	1916	700-1212.1		7 g
Fort Chaffee	Nurses' Quarters	1916	700-1240		9 a1

Sorted by: INSTALLATION

INSTALLATION	BUILDING	DATE	STD_PLAN	DRWNG	TYPE
Fort Chaffee	Officers' Quarters	1916	700-1254		9 c2
Fort Chaffee	Officers' Quarters	1916	700-1257		9 c2
Fort Chaffee	Cold Storage	1916	700-1265R		5 d1
Fort Chaffee	Guest House	1916	700-1290		9 a1
Fort Chaffee	Motor Repair Shop	1916	700-1390		10 c2
Fort Chaffee	Chapel	1916	700-1800		7 c
Fort Chaffee	Unit Guardhouse	1916	700-260		1 b
Fort Chaffee	Unit Guardhouse	1916	700-260.1		1 b
Fort Chaffee	Lavatory	1916	700-285		9 b1
Fort Chaffee	Exchange	1916	700-297		7 f
Fort Chaffee	Recreational Bldg.	1916	700-310		7 a
Fort Chaffee	Oil House 25x 49'	1916	700-323		6 a
Fort Chaffee	Physiotherapy	1916	700-348		4 b
Fort Chaffee	Motor School	1916	700-374		10 c2
Fort Chaffee	Oil Shed	1916	700-384		6 a
Fort Chaffee	Mess Patients	1916	700-44+A476		9 b2
Fort Chaffee	Medical Detachment Mess	1916	700-446		9 b2
Fort Chaffee	Officers' Mess	1916	700-450		9 b2
Fort Chaffee	Nurses' Mess	1916	700-451		9 b2
Fort Chaffee	Storehouse	1916	700-461		5 d1
Fort Chaffee	X-Ray Building	1916	700-462		4 b
Fort Chaffee	Ward Combination	1916	700-463		4 b
Fort Chaffee	Dental Clinic	1916	700-467		4 a
Fort Chaffee	Clinic	1916	700-476		4 a
Fort Chaffee	Clinic	1916	700-484		4 a
Fort Chaffee	Recreation Bldg. Patients	1916	700-520		4 a
Fort Chaffee	Fld. Office	1916	7093-451		1 c
Fort Chaffee	Fld. Office Water Stg. Tank	1916	7093-454.2		5 d1
Fort Chaffee	Heating Plant	1916	7093-501		6 a
Fort Chaffee	152 Man Mess	1916	7093-921		9 b2
Fort Chaffee	Motor Repair Shop	1916	700+A42-374		10 c2
Fort Chaffee	Service Club	1916	700-1775		7 d
Fort Chaffee	C & E Repair Shop	1916	800-1000		5 a
Fort Chaffee	Grease Rack & Insp. Rack	1916	800-1026		10 c2
Fort Chaffee	Laundry	1916	800-1029		5 c2
Fort Chaffee	Post Exchange	1916	800-1412		7 f
Fort Chaffee	Administration Bldg. (Hosp.)	1916	800-1417		1 c
Fort Chaffee	Infirmary	1916	800-1429		4 a
Fort Chaffee	Dental Clinic	1916	800-1445		4 a
Fort Chaffee	Morgue	1916	800-1454		4 b
Fort Chaffee	Clinic	1916	800-1513		4 a
Fort Chaffee	Laundry Steam Plant	1916	800-1619		5 c2
Fort Chaffee	Station QM Office Boiler Hs.	1916	800-201		6 a
Fort Chaffee	Administration Bldg.	1916	800-204		1 c
Fort Chaffee	Armament	1916	800-210		5 d2
Fort Chaffee	Sta. HQ. Office	1916	800-214		1 c
Fort Chaffee	Post Office	1916	800-217		1 d
Fort Chaffee	Sm Finance. Bldg.	1916	800-219		1 c
Fort Chaffee	Officers Quarters	1916	800-306		9 c2
Fort Chaffee	Officers' Quarters	1916	800-307		9 c2
Fort Chaffee	Prisoner's Barracks	1916	800-443		9 a2
Fort Chaffee	Nurses Recreation Room	1916	800-451		7 a

Sorted by: INSTALLATION

INSTALLATION	BUILDING	DATE	STD_PLAN	DRWNG	TYPE
Fort Chaffee	Med. Detachment Recr.	1916	800-459		7 a
Fort Chaffee	Recreation Bldg.	1916	800-460		7 a
Fort Chaffee	Sports Arena	1916	800-465		7 b
Fort Chaffee	Gas Sta. & Pump House	1916	800-601		10 c1
Fort Chaffee	Q.M. Utility Shop	1916	800-603		5 a
Fort Chaffee	Motor Repair Shop	1916	800-606		10 c2
Fort Chaffee	Rm. & Storage Bays	1916	800-607		5 d1
Fort Chaffee	Salvage Warehouse	1916	800-652		5 d1
Fort Chaffee	Warehouse (Insulated)	1916	800-654		5 d1
Fort Chaffee	Dispatching House	1916	800-661		10 c2
Fort Chaffee	Storehouse	1916	800-663		5 d1
Fort Chaffee	Storehouse	1916	800-664		5 d1
Fort Chaffee	Bakery	1916	800-682		5 c1
Fort Chaffee	Ice Storage	1916	800-777		5 d1
Fort Chaffee	Fire Station	1916	800-800		1 a
Fort Chaffee	Officers' Club	1916	800-809		7 d
Fort Chaffee	112 Man Mess	1916	800-847		9 b2
Fort Chaffee	E.M. Mess	1916	800-849		9 b2
Fort Chaffee	E.M. Mess (M-248 less one 8' bay)	1916	800-851		9 b2
Fort Chaffee	Radio Range Bldg.	1916	800-905		2 a
Fort Chaffee	Tel. & Tel. Bldg.	1916	800-907		2 b
Fort Chaffee	Med. Detachment Admin. Bldg.	1916	800-A101210		1 c
Fort Chaffee	Detention Ward	1916	800.-1424		4 b
Fort D.A. Russel	Hosp Corps Bar.	1908	1-729-S.P.S.		9 a2
Fort D.A. Russel	Hospital Corps Barracks	1912	2-76		9 a2
Fort D.A. Russel	Field Officers Qtrs	1909	215		9 c2
Fort D.A. Russel	4-Set Officers Qtrs	1911	267-B		9 c2
Fort D.A. Russel	War Dept Theater	1939	608-360 - 366		7 g
Fort D.A. Russel	Company Officers Qtrs	N.D.	625-1486 & 1487		9 c2
Fort D.A. Russel	Double NCO Quarters	1931	625-1543 & 1544		9 c1
Fort D.A. Russel	Double NCO Quarters	1933	625-2510 & 2511		9 c1
Fort D.A. Russel	Med. Detachment Barracks	1939	6560-140 - 142		9 a2
Fort D.A. Russel	Gymnasium	1940	6560-145 - 179		7 b
Fort D.A. Russel	Crematory	1908	I-620-B		6 c
Fort Lewis, WA	Magazine, Post Ordnance	1934	19-2-70	X	5 d2
Fort Lewis, WA	Trestle, Coal	1918	RR 9	X	10 d1
Fort McPherson	Ordnance Storehouse, 30x50	1897	103-A		5 d1
Fort McPherson	Subsistence Storehouse	1897	106		5 d1
Fort McPherson	Boiler/Pump House	1905	132-H		6 a
Fort McPherson	Quartermaster Stable, 129x67	1908	139-H		10 b1
Fort McPherson	Quartermaster Stable, 145x67	1910	139-L		10 b1
Fort McPherson	BOQ, 33x140, 33x45, 12x33	1904	152-B	X	9 a1
Fort McPherson	Electric Sub Station, 10x12	1909	4-936		6 a
Fort McPherson	Mess Hall, 144x177, 800 men	1893	42		9 b2
Fort McPherson	Magazine, 12x15, brick	1893	46		5 d2
Fort McPherson	War Dept Theatre, 85x49	1939	6217-105 to 107		7 g
Fort McPherson	Film Vault, size illegible	?	6217-127?		5 d1
Fort McPherson	Clinic 28 beds, 34x130, 9x30	1930	6217-36 to 45		5 d1
Fort McPherson	Kitchen & Mess, 24x100, 31x33	1930	6217-47 to 57		9 b2

Sorted by: INSTALLATION

INSTALLATION	BUILDING	DATE	STD_PLAN	DRWNG	TYPE
Fort McPherson	Dental Clnic & Cont. Ward, 34x130	1939	6217-65, 74, 76		4 a
Fort McPherson	Nurses Quarters, 13 nurses	1933	707-102 to 107		9
Fort McPherson	Double barracks, 39x150	1904	75-G		9 a2
Fort McPherson	Guard House, 60x85	1891	9		1 b
Fort McPherson	DbI Mess Hall & Kit, 140x42,	1906	93-K		9 b2
Fort McPherson	Hose House, 30x50	1898	Post		6 b
Fort Riley, KS	Quarters for Two Lieutanants	1907	120-H	X	9 c2
Fort Riley, KS	Stables	1938	14-7-illegible	X	10 b1
Fort Riley, KS	Stables	1938	14-9-illegible	X	10 b1
Fort Riley, KS	Quarters for Field Officer	1905	145-D	X	9 c2
Fort Riley, KS	B.O.Q	1902	152	X	9 a1
Fort Riley, KS	Post Exchange & Gymnasium	1906	174	X	7 a
Fort Riley, KS	B.O.Q.	N.D.	188	X	9 a1
Fort Riley, KS	Granary	1907	193	X	5 d1
Fort Riley, KS	Officers Quarters 4 Officers	1909	237-A	X	9 c2
Fort Riley, KS	Quarters for Civilian Employees	1909	258	X	9 c1
Fort Riley, KS	Stable Guard House	lleg	39-C		10 b1
Fort Riley, KS	Shop Building	1916	407	X	5 a
Fort Riley, KS	Sewage Treat. Plnt, Cntrl Hse	1942	408-204	X	6 b
Fort Riley, KS	Bakery	1902	49H	X	5 c1
Fort Riley, KS	Band Barracks	1907	61-F	X	9 a2
Fort Riley, KS	Admin Bldg? No Title	N.D.	6139-307	X	1 c
Fort Riley, KS	Academic Building	1938	6139-310	X	3 a
Fort Riley, KS	Field Officers Quarters	1932	625-1341	X	9 c2
Fort Riley, KS	Double NCO Quarters, 2 sty, brick	1930	625-1444		9
Fort Riley, KS	Double NCO Quarters 2 sty, brick	1930	625-1530	X	9 c1
Fort Riley, KS	Double NCO Quarters, w sty, brick	1930	625-1543		9 c1
Fort Riley, KS	NCO Quarters - type c - brick	1932	625-1556	X	9 c1
Fort Riley, KS	Double NCO Quarters, 2 sty, stone	1938	625-3570-3	X	9 c1
Fort Riley, KS	Double NCO Quarters, 2 sty, brick	1935	625-3571	X	9 c1
Fort Riley, KS	Double NCO Quarters, 2 story, stone	1938	625-3571-3	X	9 c1
Fort Riley, KS	Double NCO Quarters, 2 sty, brick	1935	625-3572	X	9 c1
Fort Riley, KS	Double NCO Quarters, 2 story stone	1938	625-3572-3	X	9 c1
Fort Riley, KS	NCO Double Quarters	1930	625-541	X	9 c1
Fort Riley, KS	4 Family Apt. House, Company Ofcrs	1928	625-803		9 c2
Fort Riley, KS	4 Family Apt. House, Company Ofcrs	1930	625-806	X	9 c2
Fort Riley, KS	Four Family Apartment House	1930	625-808	X	9 c2
Fort Riley, KS	Typical Dry Cleaning Plant	1930	633-165		5 c2
Fort Riley, KS	Infirmary - Large	1940	700-279		4 a
Fort Riley, KS	Post Office, Type PO-1	1937	700-298	X	1 d
Fort Riley, KS	Shop - Utilities	1937	700-317	X	5 a
Fort Riley, KS	Cavalry Barracks	1902	75	X	9 a2
Fort Riley, KS	Cold Storage Bldg	?	800-1226	X	5 d1
Fort Riley, KS	Four Set Civillian's Quarters	1909	82-N	X	9 c1
Fort Riley, KS	Incinerator	1938	A-13-1		6 c
Fort Riley, KS	Artillery Guard House	1908	A-13-9	X	1 b
Fort Riley, KS	Stable - School of Equitation	1939	A-14-12	X	10 b1
Fort Riley, KS	Lab Building for Vet Hosp	1907	A-14-16	X	8 a
Fort Riley, KS	Stable	1938	A-14-4		10
Fort Riley, KS	Commissary Store House	1905	A-19-1	X	5 d1
Fort Riley, KS	Barracks	1938	A-19-14		9 a2

Sorted by: INSTALLATION

INSTALLATION	BUILDING	DATE	STD_PLAN	DRWNG	TYPE
Fort Riley, KS	Dispatcher's Office	1939	A-19-4		10 c2
Fort Riley, KS	Quarters for Packers	N.D.	A-2-17	X	9 a2
Fort Riley, KS	Quarters, no designation	1939	A-2-3	X	9 c1
Fort Riley, KS	Revised Plan of Engineer Garage	1937	A-20-12	X	9 d1
Fort Riley, KS	NCO Garages	1940	A-20-7	X	9 d1
Fort Riley, KS	Quarters, no designation	1939	A-4-7	X	9 c2
Fort Riley, KS	Quarters, no designation	1938	A-4-9	X	9 c2
Fort Riley, KS	Q.M. Gas Station	1932	A-5-21	X	10 c1
Fort Riley, KS	Packing & Crating shop	1938	A-8-12	X	5 a
Fort Riley, KS	Airplane Hangar	N.D.	Butler Mfg Co	X	10 a1
Fort Riley, KS	Battery Stables	N.D.	E.B. Williston	X	10 b1
Fort Riley, KS	Administration Building	N.D.	Geo. E. Pond		1 c
Fort Riley, KS	Proposed Administration Building	N.D.	Geo. E. Pond		1 c
Fort Riley, KS	Cavalry Stables	N.D.	Geo. E. Pond	X	10 b1
Fort Riley, KS	Dispensary	N.D.	Geo. E. Pond	X	4 a
Fort Riley, KS	Battery Workshops	N.D.	Geo. E. Pond	X	5 a
Fort Riley, KS	Ordnance Store House	N.D.	Geo. E. Pond	X	5 d2
Fort Riley, KS	Post Exchange & Gymnasium	N.D.	Geo. E. Pond	X	7 a
Fort Riley, KS	Artillery Barracks, 80 Men	1896	Geo. E. Pond	X	9 a2
Fort Riley, KS	Cavalry Barracks	N.D.	Geo. E. Pond	X	9 a2
Fort Riley, KS	Outhouse for Cavalry Barracks	N.D.	Geo. E. Pond	X	9 b1
Fort Riley, KS	Frame Quarters for NCO	1928	Geo. E. Pond	X	9 c1
Fort Riley, KS	Non-Commissioned Officers Quarters	N.D.	Geo. E. Pond	X	9 c1
Fort Riley, KS	Quarters for Steam Heating Engineer	N.D.	Geo. E. Pond	X	9 c1
Fort Riley, KS	Proposed Field Officers Quarters	N.D.	Geo. E. Pond	X	9 c2
Fort Riley, KS	Quarters for Commanding Officer	N.D.	Geo. E. Pond	X	9 c2
Fort Riley, KS	Cavalry Stable Guard Building	1896	George Ruhlen	X	1 b
Fort Riley, KS	Double Quarters for Officer	1902	SPL 3-368	X	9 c2
Fort Riley, KS	Officers Quarters	1902	SPL 3-381		9 c2
Manual Cnstr Div	Cantonment: R'mnt Sta 7500 Animals	1918	404-48	X	10 b1
Manual Cnstr Div	Lecture Hall, 51x77	1918	608-104		7 a
Manual Cnstr Div	Theatre, Class a, 120x187	1918	608-24		7 g
Manual Cnstr Div	Theatre, Liberty, Class D	1918	608-31to34&106		7 g
Manual Cnstr Div	Cantonment: Div HQ	1918	610-221 & 227	X	11 a
Manual Cnstr Div	Cantonment: Rgmt Inf, Brigd HQ	1918	610-222	X	11 a
Manual Cnstr Div	Cantonment: Rgmt Lt Art'ly	1918	610-225	X	11 a
Manual Cnstr Div	Cantonment: Rgmt Hvy Art'ly	1918	610-226	X	11 a
Manual Cnstr Div	Cantonment: Camp Center	1918	610-232	X	11 a
Manual Cnstr Div	Cantonment: Depot Brgd HQ	1918	610-233	X	11 a
Manual Cnstr Div	Cantonment: RR Terminal	1918	610-238	X	10d1
Manual Cnstr Div	Cantonment: Qrnt'n Camp 1000 men	1918	610-274	X	11 a
Manual Cnstr Div	Gas Instruction, 16x30	1918	6143-2		3 a
Manual Cnstr Div	Magazine, Black P'wdr, 16x22	1918	6196-104		5 d2
Manual Cnstr Div	Garage, 50' x var.	1918	620-301		9 d1
Manual Cnstr Div	Infirmary - Medical, 30'x63'	1918	620-302		4 a
Manual Cnstr Div	Infirmary & Dental Ops Bldg. 30'x88	1918	620-307 & 308		4 a
Manual Cnstr Div	Infirm./Dntl Dorm Bldg, 30'x88'	1918	620-310 & 311		4 a
Manual Cnstr Div	Barrack, 30'x60'	1918	620-313		9 a2
Manual Cnstr Div	Store House, Regmtl, 20xvar.	1918	620-318		5 d1
Manual Cnstr Div	Northern & Southern Constr Zones	1918	620-320-2-182	X	11a
Manual Cnstr Div	Garage, 65' x 108'	1918	620-322 & 323		9 d1

Sorted by: INSTALLATION

INSTALLATION	BUILDING	DATE	STD_PLAN	DRWNG	TYPE
Manual Cnstr Div	Lav. w/out shwrs: 17x14, 17x21, 17x	1918	620-324		9 b1
Manual Cnstr Div	Detention Hut, 20'x20'	1918	620-326		4
Manual Cnstr Div	Admin. Building, 20' x 84'	1918	620-327		1 c
Manual Cnstr Div	Tel. & Teleg. Bldg, 20x70	1918	620-328		2 b
Manual Cnstr Div	Guard house, Regimental 20'x56'	1918	620-331		1 b
Manual Cnstr Div	Shed - Wagon or Gun, 29xvar.	1918	620-332		5 d2
Manual Cnstr Div	Infirmiry - Medical, Addition, 24'x	1918	620-333		4 a
Manual Cnstr Div	Bath House, 9'x8' to 9'x32'	1918	620-336		9 b1
Manual Cnstr Div	Officers Quarters, 20x49	1918	620-337		9 c2
Manual Cnstr Div	Bakery, 30'x70'	1918	620-340		5 c1
Manual Cnstr Div	Fire Station, 24'x77'	1918	620-341		1 a
Manual Cnstr Div	Barrack, 30'x50'	1918	620-342		9 a2
Manual Cnstr Div	Officers Quarters, 30xvar.	1918	620-343		9 c2
Manual Cnstr Div	Officers Quarters, 20x28	1918	620-344		9 c2
Manual Cnstr Div	Lavatory w/showers, 20x49	1918	620-345		9 b1
Manual Cnstr Div	Lavatory w/showers, 20x42	1918	620-346		9 b1
Manual Cnstr Div	Lavatory w/showers, 20x35	1918	620-347		9 b1
Manual Cnstr Div	Lavatory w/showers, 20x21, x28	1918	620-348		9 b1
Manual Cnstr Div	Lavatory w/showers, 14x14, 14x20	1918	620-349		9 b1
Manual Cnstr Div	Dtchmnt Bar., w/out mess 20' x var.	1918	620-353		9 a2
Manual Cnstr Div	Officers Quarters, 30xvar.	1918	620-354		9 c2
Manual Cnstr Div	Detach. Bar., w/mess 20' x var.	1918	620-355		9 a2
Manual Cnstr Div	Administration Building, 20'x49'	1918	620-356		1 c
Manual Cnstr Div	Post Exchange, 32x91	1918	620-359		7 f
Manual Cnstr Div	Bakery, 40'x136 & 51'x62'	1918	620-361 & 362		5 c1
Manual Cnstr Div	Officers Quarters, 20xvar.	1918	620-363		9
Manual Cnstr Div	Officers Quarters, 20xvar.	1918	620-364		9 c2
Manual Cnstr Div	Fire Station, 31'x88'	1918	620-365		1 a
Manual Cnstr Div	Barrack, 30'x40'	1918	620-366		9 a2
Manual Cnstr Div	Infirmiry - Medical, 30'x77'	1918	620-368 to 375		4 a
Manual Cnstr Div	Officer's Qtrs, 20x21 types A,B,C	1918	620-369		9 c2
Manual Cnstr Div	Magazine, 20'x20'	1918	620-370		5 d2
Manual Cnstr Div	Magazine, 24'x60'	1918	620-371		5 d2
Manual Cnstr Div	Shop, 20x36	1918	620-372		5 a
Manual Cnstr Div	Prisoner's Barrack & Yard, 30'x9	1918	620-373		9 a2
Manual Cnstr Div	Guard Barrack, 30'x90'	1918	620-373-A		9 a2
Manual Cnstr Div	Post Office Building, 32x51	1918	620-374		1 d
Manual Cnstr Div	Stable - open 24xvar.	1918	620-376		10 b1
Manual Cnstr Div	Hay Shed, 60'x165'	1918	620-378		10 b1
Manual Cnstr Div	Bakery, 40'x136'	1918	620-379		5 c1
Manual Cnstr Div	Shop, Clothing etc 30x102	1918	620-381		5 a
Manual Cnstr Div	Infirmiry - Medical, 30'x105'	1918	620-382		4 a
Manual Cnstr Div	Infirmiry - Medical, 30'x112'	1918	620-383 & 384		4 a
Manual Cnstr Div	Warehouse, Clothing, 60x100	1918	620-385 & 386		5 d1
Manual Cnstr Div	Shop, Motor Repair, 60x130	1918	620-387 & 388		10 c2
Manual Cnstr Div	Shop, QMaster, 2 bldgs each, 36x106	1918	620-390		5 a
Manual Cnstr Div	Infirmiry - Medical, 30'x98'	1918	620-392 & 393		4 a
Manual Cnstr Div	Stable Guard , 20x21	1918	620-395		5 a
Manual Cnstr Div	Oil house, 20x30	1918	620-396		6 a
Manual Cnstr Div	Auto & Mtr Serv Sta, 35'x41'	1918	620-397		10
Manual Cnstr Div	Store House, Salvage, 60x168	1918	620-412 & 413		5 d1
Manual Cnstr Div	Telegraph office & Quarters, 20x110	1918	620-418		2 b

Sorted by: INSTALLATION

INSTALLATION	BUILDING	DATE	STD_PLAN	DRWNG	TYPE
Manual Cnstr Div	Bakery, 30'x50'	1918	620-428		5 c1
Manual Cnstr Div	Meat Inspection Platform, 10'x66'	1918	620-429		9 b2
Manual Cnstr Div	Waste & Transfer Station, 20x130	1918	620-432		6 c
Manual Cnstr Div	Rendering Plant, 32x48	1918	620-435		5 b
Manual Cnstr Div	Shop, Cot repair, 40x36	1918	620-436		5 a
Manual Cnstr Div	Shop, Clothing, etc, 60x100	1918	620-437		5 a
Manual Cnstr Div	Shop, Tent Treating, 36x40	1918	620-439		5 a
Manual Cnstr Div	Shop, Tent Repair, 40x60	1918	620-440		5 a
Manual Cnstr Div	Fire Station, 31'x88'	1918	620-441		1 a
Manual Cnstr Div	Mess Building, 30x120 , x132, x144	1918	620-442		9 b2
Manual Cnstr Div	Hose House (Type A & B) 6'x7'	1918	620-445 & 446		6 b
Manual Cnstr Div	Fire Station, 31'x103	1918	620-447		1 a
Manual Cnstr Div	Infirmary - Medical, 30'x56'	1918	620-449		4 a
Manual Cnstr Div	Classroom Building, 30' x 60'	1918	620-450		3 a
Manual Cnstr Div	Shower shelter & wash house, 20x80	1918	620-451		9 b1
Manual Cnstr Div	Magazine, brick w/corr steel rf, 10	1918	620-452		5 d2
Manual Cnstr Div	Barrack & lavatory, 43'x120'	1918	620-457 & 458		9 a2
Manual Cnstr Div	Shop, Clothing, etc 28x132, 28x162	1918	620-467		5 a
Manual Cnstr Div	Classroom Building, 49'x150	1918	620-469 & 470		3 a
Manual Cnstr Div	Refrigeration Plant, 20x72	1918	620-471 & 472		9 b2
Manual Cnstr Div	Refrigeration Cooling Tower,	1918	620-473		9 b2
Manual Cnstr Div	Shop, Motor Repair, 75x96	1918	620-478 & 479		10 c2
Manual Cnstr Div	Coffee Roasting & Grinding Plant	1918	620-490 & 491		5 b
Manual Cnstr Div	Boiler Houses	1918	620-492		6 a
Manual Cnstr Div	Garage for Ambulances, 22'x47'	1918	620-496		4 b
Manual Cnstr Div	Liberty Theatre, 60x120	1918	620-499 & 500		7 g
Manual Cnstr Div	Bakery 33'x51'	1918	620-505		5 c1
Manual Cnstr Div	Classroom Building, 30'x60'	1918	620-507		3 a
Manual Cnstr Div	Ordnance Repair Shop 30x106	1918	620-508		5 a
Manual Cnstr Div	Garage, 30' x var.	1918	620-511		9 d1
Manual Cnstr Div	Lavatory w/showers, 20x50	1918	620-523		9 b1
Manual Cnstr Div	Garage, open, 50'xvar.	1918	620-524		9 d1
Manual Cnstr Div	Garage, closed, 70'x180'	1918	620-525		9 d1
Manual Cnstr Div	Cafeteria, 105x192	1918	6209-113		9 b2
Manual Cnstr Div	Garage, Mechanical Repair, 140x144	1918	6242-5		9 d1
Manual Cnstr Div	Storage Depot/admin Bldg, 140x160	1918	6271-7		5 d1
Manual Cnstr Div	Dormitory for men, 28x113	1918	6307-110		9 a2
Manual Cnstr Div	Housing, 4 families, 38x53	1918	6309-121		9 c1
Manual Cnstr Div	Housing, 1 family, 24x30	1918	6309-150		9 c1
Manual Cnstr Div	Housing, Boarding, 27x38	1918	6309-160		9 c1
Manual Cnstr Div	Housing, 1 family, 24x36	1918	6309-180		9 c1
Manual Cnstr Div	Housing, 1 family, 24x32	1918	6309-190		9 c1
Manual Cnstr Div	Housing, 2 family, 25x36	1918	6309-200		9 c1
Manual Cnstr Div	Garage, 61x164	1918	6311-105		9 d1
Manual Cnstr Div	Delousing Plant, 48x84	1918	632-551		4 a
Manual Cnstr Div	Delousing Plant, 60x204	1918	632-552		4 a
Manual Cnstr Div	Laundry, 72x216, 5-10,000 men	1918	633-130		5 c2
Manual Cnstr Div	Laundry, 36x108, 1-2,000 men	1918	633-140		5 c2
Manual Cnstr Div	Dormitory & Dining Room, 29x136	1918	6339-111		9 a2
Manual Cnstr Div	Cafeteria, 54x189	1918	6339-131		9 b2
Manual Cnstr Div	Cafeteria, 132x173	1918	6370-106		9 b2
Manual Cnstr Div	Cafeteria, 110x171	1918	6383-110		9 b2

Sorted by: INSTALLATION

INSTALLATION	BUILDING	DATE	STD_PLAN	DRWNG	TYPE
Manual Cnstr Div	Welfare Bldg, 84x96	1918	6399-120		1 c
Manual Cnstr Div	Cafeteria, 156x200	1918	6403-111		9
Manual Cnstr Div	Magazine, Smokeless powdr, 32x96	1918	652-146		5 d2
Manual Cnstr Div	Pyrotech Plant Type D, 20x35	1918	652-152		5 b
Manual Cnstr Div	Pyrotech Plant Type 1 & 2, 30x161	1918	652-157		5 b
Manual Cnstr Div	Pyrotech Plant Type J & J1, 20x35	1918	652-158		5 b
Manual Cnstr Div	Shed, Dock, 60x122	1918	652-165		5 d2
Manual Cnstr Div	Magazine, Type 13, 26x42	1918	652-169		5 d2
Manual Cnstr Div	Garage, Ordinance, 50xvar.	1918	652-17		9 d1
Manual Cnstr Div	Primer & Fuse house #1, 32x96	1918	652-173		5 d2
Manual Cnstr Div	Primer & Fuse house #2, 32x96	1918	652-174		5 d2
Manual Cnstr Div	Magazine, Type 10, 49x208	1918	652-179		5 d2
Manual Cnstr Div	Magazine, Type 11, H.E. 26x42	1918	652-180		5 d2
Manual Cnstr Div	Storage, Vehicles # 3, 161xvar	1918	652-188		10 c2
Manual Cnstr Div	Shop, Ordinance Repair, 30x80	1918	652-19		5 a
Manual Cnstr Div	Guard House, Type 1, 20x56	1918	652-214		1 b
Manual Cnstr Div	Magazine, Type 12, 26x42	1918	652-31		5 d2
Manual Cnstr Div	Storehouse, General, #1, 161x501	1918	652-41		5 d1
Manual Cnstr Div	Storage, Vehicles, #1, 113x513	1918	652-43		10 c2
Manual Cnstr Div	Storehouse, General, #2	1918	652-74		5 d1
Manual Cnstr Div	Transformer Sta. Type 1, 20x36	1918	652-81		6 a
Manual Cnstr Div	Road Cross Section, Typical	1918	LA-1	X	11 a
Manual Cnstr Div	Road Cross Sections, Typical	1918	LA-2	X	11a
Manual Cnstr Div	Standard Railway Trestle	1918	RR-1	X	10 d1
Manual Cnstr Div	Std. Railway Coal Trestle	1918	RR-2	X	10 d1
Manual Cnstr Div	Std. Timber Coal Pocket	1918	RR-3	X	10
Manual Cnstr Div	Turnout & Crossover, Railways	1918	RR-4	X	10 d2
Manual Cnstr Div	Std. Trestle Bumper, Railways	1918	RR-5	X	10 d1
Manual Cnstr Div	Roadbed Sectons, Railways	1918	RR-6	X	10 d2
Manual Cnstr Div	Terminal General Plan	1918	RR-7	X	11a
Manual Cnstr Div	Terminals General Plans	1918	RR-8	X	11a
Manual Cnstr Div	Typical 1 Story Building	1918	SB 1	X	11a
Manual Cnstr Div	Typ Em'gncy Str'g Whse Toilet Rms	1918	SB 10	X	5 d1
Manual Cnstr Div	Elec Distrib Syst, Street Lighting	1918	SB 11	X	6a
Manual Cnstr Div	Elec Distrib Syst, 2ndary Lines	1918	SB 12	X	6a
Manual Cnstr Div	Typ Hospital Kitchen Layouts	1918	SB 13	X	9 b2
Manual Cnstr Div	Hospital Typ Kitchen Layouts	1918	SB 14	X	4 b
Manual Cnstr Div	Typical Mess Buildings	1918	SB 15	X	9 b2
Manual Cnstr Div	Store House, Divisional, 60x168	1918	SB 16	X	5 d1
Manual Cnstr Div	Stable - closed, 29xvar.	1918	SB 17	X	10 b1
Manual Cnstr Div	Det Hut & Kitchen, Det & Qrtn Camp	1918	SB 18	X	9 b2
Manual Cnstr Div	Recruit Exam. Bldg / Shop	1918	SB 19	X	4 a
Manual Cnstr Div	Typical 2 Story Building	1918	SB 2	X	11a
Manual Cnstr Div	Standard Laundry, 10-20,000 men	1918	SB 20		5 c2
Manual Cnstr Div	Delousing Plant, 54x120	1918	SB 21	X	4 a
Manual Cnstr Div	Dormitories w/Mess	1918	SB 22	X	9 a2
Manual Cnstr Div	Magazine, Type 1 & Type 2	1918	SB 23	X	5 d2
Manual Cnstr Div	Auditorium, 200x300	1918	SB 24	X	7 a
Manual Cnstr Div	Emg'ncy Whse C'prtmt & Group Plan	1918	SB 25	X	5 d1
Manual Cnstr Div	Typ. Em'gncy Str'g Whse Admin Bldg	1918	SB 26	X	5 d
Manual Cnstr Div	Emg'ncy Whse, Open Shed	1918	SB 27	X	5 d1
Manual Cnstr Div	Refrigerating & Ice Making Plant	1918	SB 28	X	5 b

Sorted by: INSTALLATION

INSTALLATION	BUILDING	DATE	STD_PLAN	DRWNG	TYPE
Manual Cnstr Div	Typical 2 Sty Building, Details	1918	SB 3	X	11a
Manual Cnstr Div	Typical Barracks, 66 Men	1918	SB 4	X	9 a2
Manual Cnstr Div	Typical 2 Story Officers Qtrs	1918	SB 5	X	9 c2
Manual Cnstr Div	Typical Lavatories	1918	SB 6	X	9 b1
Manual Cnstr Div	Typical Lavatories Details	1918	SB 7	X	9 b1
Manual Cnstr Div	Standard Incinerator	1918	SB 8	X	6 c
Manual Cnstr Div	Standard Steel & Wood Hangars	1919	SB 9	X	10 a1
Manual Cnstr Div	Layout: Hospital	1918	SGO-A	X	4 b
Manual Cnstr Div	Layout: Head House	1918	SGO-A1	X	4 b
Manual Cnstr Div	Typical Hosp Admin Bldg	1918	SGO-B	X	4 b
Manual Cnstr Div	Typical Hosp Laboratory Bldg	1918	SGO-F	X	4 b
Manual Cnstr Div	Typical Hosp Operating Pavillion	1918	SGO-G	X	4 b
Manual Cnstr Div	Typical Hosp General Mess & Kitchen	1918	SGO-I1 & I32	X	4 b
Manual Cnstr Div	Typical Hosp General Mess & Kitchen	1918	SGO-I28	X	4 b
Manual Cnstr Div	Typical Hosp Receiving Ward	1918	SGO-J	X	4 b
Manual Cnstr Div	Typical Hosp Single Wards	1918	SGO-K1	X	4 b
Manual Cnstr Div	Typical Hosp Single Wards	1918	SGO-K34	X	4 b
Manual Cnstr Div	Typical Hosp Single Wards	1918	SGO-K35	X	4 b
Manual Cnstr Div	Typ. Hosp Phys Thrpy & Amusmnt Hall	1918	SGO-S & T	X	4 b
Manual for QMC	Kit. & Dining Rm, 72 Men, Mob. Cmps	1916	15-6	X	9 b2
Manual for QMC	Temporary Bldgs for Mob Camps	1916	16-1	X	11a
Manual for QMC	Admin Building, Mobilization Camps	1916	16-10	X	1 c
Manual for QMC	Guard House, Mobilization Camps	1916	16-11	X	1 b
Manual for QMC	Store House, Mobilization Camps	1916	16-12	X	5 d1
Manual for QMC	Hospital, Mobilization Camps	1916	16-13	X	4 b
Manual for QMC	Ward Building, Mobilization Camps	1916	16-14	X	4 b
Manual for QMC	Post Exchange, Mobilization Camps	1916	16-15	X	7 f
Manual for QMC	Field Bakery, Mobilization Camps	1916	16-16	X	5 c1
Manual for QMC	Animal Shelter, Mobilization Camps	1916	16-17	X	10 b1
Manual for QMC	Vehicle Shelter, Mobilization Camps	1916	16-18	X	10 c2
Manual for QMC	Officers Quarters, Lge, Mob. Camps	1916	16-2	X	9 a1
Manual for QMC	Officers Quarters, Sml, Mob. Camps	1916	16-3	X	9 a1
Manual for QMC	NCO Barracks, Mobilization Camps	1916	16-4	X	9 a2
Manual for QMC	Barrack, Enl'std Men, Mob. Camps	1916	16-5	X	9 a2
Manual for QMC	Mess Building, Mobilization Camps	1916	16-6	X	9 b2
Manual for QMC	Kitchen, Mobilization Camps	1916	16-7	X	9 b2
Manual for QMC	Latrine, Mobilization Camps	1916	16-8	X	9 b1
Manual for QMC	Bath House, Mobilization Camps	1916	16-9	X	9 b1
Marshall Field	Operations Building	1940	613-9365		1 c
Marshall Field,	Operations Building	1940	6139-366		1 c
Marshall Field,	Barracks	1938	621-1072	X	9 a2
Marshall Field,	Field Officers Quarters	1932	625-1301	X	9 c2
Marshall Field,	Field Officers Quarters	1933	625-1340	X	9 c2
Marshall Field,	Company Officers Quarters	1932	625-2491	X	9 c2
Marshall Field,	Paint Oil & Dope House	1940	702-118	X	5 d1
Office of QMG	Typ L'scp Pl'tg: CO & Dbl CO Qtrs	1935	630-100	X	11 a
Office of QMG	Typical Street Tree Planting	1935	630-102	X	11 a
Office of QMG	Typ L'scp Pl'tg: Th'tre, Hosp, Chpl	1935	630-103	X	11 a
Office of QMG	Typ. L'scp Pl'tg: HQ, Admin, BOQ	1935	630-Illegible	X	11 a

Sorted by: BUILDING NAME

BUILDING	DATE	STD_PLAN	DRWNG	TYPE	INSTALLATION
112 Man Mess	1916	800-847		9 b2	Fort Chaffee
152 Man Mess	1916	7093-921		9 b2	Fort Chaffee
4 Family Apt. House, Company Ofcrs	1928	625-803		9 c2	Fort Riley, KS
4 Family Apt. House, Company Ofcrs	1930	625-806	X	9 c2	Fort Riley, KS
4 Set Officers Quarters	1911	237-B		9 c2	F.E. Warren AFB
4-Set Officers Qtrs	1911	267-B		9 c2	Fort D.A. Russel
Academic Building	1938	6139-310	X	3 a	Fort Riley, KS
Admin Bldg? No Title	N.D.	6139-307	X	1 c	Fort Riley, KS
Admin Building (Artillery)	1911	122-F		1 c	F.E. Warren AFB
Admin Building, Mobilization Camps	1916	16-10	X	1 c	Manual for QMC
Admin. Building, 20' x 84'	1918	620-327		1 c	Manual Cnstr Div
Administration Bldg.	1916	800-204		1 c	Fort Chaffee
Administration Bldg. (Hosp.)	1916	800-1417		1 c	Fort Chaffee
Administration Building	1911	112-F		1 c	F.E. Warren AFB
Administration Building	N.D.	Geo. E. Pond		1 c	Fort Riley, KS
Administration Building, 20'x49'	1918	620-356		1 c	Manual Cnstr Div
Air Corps Hangar	1930	695-272	X	10 a1	Chief of Air Corps
Air Corps Hangar, E Design	1931	695-284	X	10 a1	Chief of Air Corps
Airplane Hangar	N.D.	Butler Mfg Co	X	10 a1	Fort Riley, KS
Ammunition Storehouse	1910	262		5 d2	F.E. Warren AFB
Animal Shelter, Mobilization Camps	1916	16-17	X	10 b1	Manual for QMC
Armament	1916	800-210		5 d2	Fort Chaffee
Artillery Barracks, 80 Men	1896	Geo. E. Pond	X	9 a2	Fort Riley, KS
Artillery or Infantry Stables	1908	139-K		10 b1	F.E. Warren AFB
Artillery Shop	1908	59-V		5 a	F.E. Warren AFB
Artillery Stables	1904	139-C		10 b1	F.E. Warren AFB
Artillery Barracks	1904	150		9 a2	F.E. Warren AFB
Artillery Barracks	1908	181		9 a2	F.E. Warren AFB
Artillery Exchange	1910	122-B		7 f	F.E. Warren AFB
Artillery Gun Shed	1909	209		5 d2	F.E. Warren AFB
Artillery Workshop	1904	59-K		5 a	F.E. Warren AFB
Artillery Guard House	1908	A-13-9	X	1 b	Fort Riley, KS
Auditorium, 200x300	1918	SB 24	X	7 a	Manual Cnstr Div
Auto & Mtr Serv Sta, 35'x41'	1918	620-397		10 c1	Manual Cnstr Div
B.O.Q	1902	152	X	9 a1	Fort Riley, KS
B.O.Q.	N.D.	188	X	9 a1	Fort Riley, KS
Bachelor Officers Quarters	1908	152-G		9 a1	F.E. Warren AFB
Bachelor Officers Quarters	1910	152-L		9 a1	F.E. Warren AFB
Bakery	1916	800-682		5 c1	Fort Chaffee
Bakery	1902	49H	X	5 c1	Fort Riley, KS
Bakery 33'x51'	1918	620-505		5 c1	Manual Cnstr Div
Bakery, 30'x50'	1918	620-428		5 c1	Manual Cnstr Div
Bakery, 30'x70'	1918	620-340		5 c1	Manual Cnstr Div
Bakery, 40'x136 & 51'x62'	1918	620-361 & 362		5 c1	Manual Cnstr Div
Bakery, 40'x136'	1918	620-379		5 c1	Manual Cnstr Div
Band Barracks	1907	61-F	X	9 a2	Fort Riley, KS
Band Stand, Cavalry & Artillery	1911	64-B		7 g	F.E. Warren AFB
Barrack & lavatory, 43'x120'	1918	620-457 & 458		9 a2	Manual Cnstr Div
Barrack, 30'x40'	1918	620-366		9 a2	Manual Cnstr Div
Barrack, 30'x50'	1918	620-342		9 a2	Manual Cnstr Div
Barrack, 30'x60'	1918	620-313		9 a2	Manual Cnstr Div
Barrack, Enl'std Men, Mob. Camps	1916	16-5	X	9 a2	Manual for QMC

Sorted by: BUILDING NAME

BUILDING	DATE	STD_PLAN	DRWNG	TYPE	INSTALLATION
Barracks	1938	A-19-14		9 a2	Fort Riley, KS
Barracks	1938	621-1072	X	9 a2	Marshall Field,
Bath House, 9'x8' to 9'x32'	1918	620-336		9 b1	Manual Cnstr Div
Bath House, Mobilization Camps	1916	16-9	X	9 b1	Manual for QMC
Battery Workshops	N.D.	Geo. E. Pond	X	5 a	Fort Riley, KS
Battery Stables	N.D.	E.B. Williston	X	10 b1	Fort Riley, KS
Boiler Houses	1918	620-492		6 a	Manual Cnstr Div
Boiler/Pump House	1905	132-H		6 a	Fort McPherson
BOQ, 33x140, 33x45, 12x33	1904	152-B	X	9 a1	Fort McPherson
C & E Repair Shop	1916	800-1000		5 a	Fort Chaffee
C.O.'s Quarters	1903	95-A		9 c2	F.E. Warren AFB
Cafeteria, 105x192	1918	6209-113		9 b2	Manual Cnstr Div
Cafeteria, 110x171	1918	6383-110		9 b2	Manual Cnstr Div
Cafeteria, 132x173	1918	6370-106		9 b2	Manual Cnstr Div
Cafeteria, 156x200	1918	6403-111		9 b2	Manual Cnstr Div
Cafeteria, 54x189	1918	6339-131		9 b2	Manual Cnstr Div
Cantonment: Camp Center	1918	610-232	X	11 a	Manual Cnstr Div
Cantonment: Depot Brgd HQ	1918	610-233	X	11 a	Manual Cnstr Div
Cantonment: Div HQ	1918	610-221 & 227	X	11 a	Manual Cnstr Div
Cantonment: Qrnt'n Camp 1000 men	1918	610-274	X	11 a	Manual Cnstr Div
Cantonment: R'mnt Sta 7500 Animals	1918	404-48	X	10 b1	Manual Cnstr Div
Cantonment: Rgmt Inf, Brigd HQ	1918	610-222	X	11 a	Manual Cnstr Div
Cantonment: Rgmt Lt Art'ly	1918	610-225	X	11 a	Manual Cnstr Div
Cantonment: RR Terminal	1918	610-238	X	10d1	Manual Cnstr Div
Cavalry Stable	1906	139		10 b1	F.E. Warren AFB
Cavalry Stable Guard Building	1896	George Ruhlen	X	1 b	Fort Riley, KS
Cavalry Band Barracks	1909	61-F		9 a2	F.E. Warren AFB
Cavalry Barracks	1910	75-M		9 a2	F.E. Warren AFB
Cavalry Barracks	1902	75	X	9 a2	Fort Riley, KS
Cavalry Barracks	N.D.	Geo. E. Pond	X	9 a2	Fort Riley, KS
Cavalry Drill Hall	1907	97-A		3 b	F.E. Warren AFB
Cavalry Granary	1909	193-A		5 d1	F.E. Warren AFB
Cavalry Post Exchange	1910	122-b		7 f	F.E. Warren AFB
Cavalry Stables	N.D.	Geo. E. Pond	X	10 b1	Fort Riley, KS
Chapel	1916	700-1800		7 c	Fort Chaffee
Civillian Employees Quarters	1911	82-P		9 c1	F.E. Warren AFB
Classroom Building, 30' x 60'	1918	620-450		3 a	Manual Cnstr Div
Classroom Building, 30'x60'	1918	620-507		3 a	Manual Cnstr Div
Classroom Building, 49'x150	1918	620-469 & 470		3 a	Manual Cnstr Div
Clinic	1916	700-476		4 a	Fort Chaffee
Clinic	1916	700-484		4 a	Fort Chaffee
Clinic	1916	800-1513		4 a	Fort Chaffee
Clinic 28 beds, 34x130, 9x30	1930	6217-36 to 45		5 d1	Fort McPherson
Coal Shed	1904	67-B		5 d1	F.E. Warren AFB
Coal Shed	1909	67-J		5 d1	F.E. Warren AFB
Coffee Roasting & Grinding Plant	1918	620-490 & 491		5 b	Manual Cnstr Div
Cold Storage	1916	700-1265R		5 d1	Fort Chaffee
Cold Storage Bldg	?	800-1226	X	5 d1	Fort Riley, KS
Commissary Building	1910	186		7 f	F.E. Warren AFB
Commissary Store House	1905	A-19-1	X	5 d1	Fort Riley, KS
Company Ofcr 4 Set Apt	1931	129		9 c2	F.E. Warren AFB
Company Officer's Quarters	1932	625-1486 & 87		9 c2	F.E. Warren AFB

Sorted by: BUILDING NAME

BUILDING	DATE	STD_PLAN	DRWNG	TYPE	INSTALLATION
Company Officers Quarters	1932	625-2491	X	9 c2	Marshall Field,
Company Officrs Qtrs	N.D.	625-1486 & 1487		9 c2	Fort D.A. Russel
Contonment: Rgmt Hvy Art'ly	1918	610-226	X	11 a	Manual Cnstr Div
Crematory	1908	1-620-B		6 c	F.E. Warren AFB
Crematory	1908	1-620-B		6 c	Fort D.A. Russel
Dbl Mess Hall & Kit, 140x42,	1906	93-K		9 b2	Fort McPherson
Delousing Plant, 48x84	1918	632-551		4 a	Manual Cnstr Div
Delousing Plant, 54x120	1918	SB 21	X	4 a	Manual Cnstr Div
Delousing Plant, 60x204	1918	632-552		4 a	Manual Cnstr Div
Dental Clinic	1916	700-467		4 a	Fort Chaffee
Dental Clinic	1916	800-1445		4 a	Fort Chaffee
Dental Clnc & Cont. Ward, 34x130	1939	6217-65, 74, 76		4 a	Fort McPherson
Det Hut & Kitchen, Det & Qrntr Camp	1918	SB 18	X	9 b2	Manual Cnstr Div
Detach. Bar., w/mess 20' x var.	1918	620-355		9 a2	Manual Cnstr Div
Detachment Barracks	1931	621-850 & 851		9 a2	F.E. Warren AFB
Detention Hut, 20'x20'	1918	620-326		4 b	Manual Cnstr Div
Detention Ward	1916	800.-1424		4 b	Fort Chaffee
Dispatcher's Office	1939	A-19-4		10 c2	Fort Riley, KS
Dispatching House	1916	800-661		10 c2	Fort Chaffee
Dispensary	N.D.	Geo. E. Pond	X	4 a	Fort Riley, KS
Dispensary (Cavalry)	1909	247		4 a	F.E. Warren AFB
Dormitories w/Mess	1918	SB 22	X	9 a2	Manual Cnstr Div
Dormitory & Dining Room, 29x136	1918	6339-111		9 a2	Manual Cnstr Div
Dormitory for men, 28x113	1918	6307-110		9 a2	Manual Cnstr Div
Double barracks, 39x150	1904	75-G		9 a2	Fort McPherson
Double Lieutenants Quarters	1909	120-F		9 c2	F.E. Warren AFB
Double NCO Quarters	1931	8682-D		9 c1	F.E. Warren AFB
Double NCO Quarters	1931	625-1543 & 1544		9 c1	Fort D.A. Russel
Double NCO Quarters	1933	625-2510 & 2511		9 c1	Fort D.A. Russel
Double NCO Quarters 2 sty, brick	1930	625-1530	X	9 c1	Fort Riley, KS
Double NCO Quarters, 2 story stone	1938	625-3572-3	X	9 c1	Fort Riley, KS
Double NCO Quarters, 2 story, stone	1938	625-3571-3	X	9 c1	Fort Riley, KS
Double NCO Quarters, 2 sty, brick	1930	625-1444		9 c1	Fort Riley, KS
Double NCO Quarters, 2 sty, brick	1935	625-3571	X	9 c1	Fort Riley, KS
Double NCO Quarters, 2 sty, brick	1935	625-3572	X	9 c1	Fort Riley, KS
Double NCO Quarters, 2 sty, stone	1938	625-3570-3	X	9 c1	Fort Riley, KS
Double NCO Quarters, type A	1933	625-2510 - 2511		9 c1	F.E. Warren AFB
Double NCO Quarters, type B	1933	625-2510 & 2518		9 c1	F.E. Warren AFB
Double NCO Quarters, w sty, brick	1930	625-1543		9 c1	Fort Riley, KS
Double Officers Quarters	1906	142-A		9 c2	F.E. Warren AFB
Double Officers Quarters	1909	142-B		9 c2	F.E. Warren AFB
Double Quarters for Officer	1902	SPL 3-368	X	9 c2	Fort Riley, KS
Double Set N.C.S.O. Quarters	1885	82-D		9 c1	F.E. Warren AFB
Double Set Officer's Quarters	1905	120-C		9 c2	F.E. Warren AFB
Double Set Officer's Quarters	1905	90		9 c2	F.E. Warren AFB
Double Set Officers Quarters	1905	120-D		9 c2	F.E. Warren AFB
Dtchmnt Bar., w/out mess 20' x var.	1918	620-353		9 a2	Manual Cnstr Div
E.M. Mess	1916	800-849		9 b2	Fort Chaffee
E.M. Mess (M-248 less one 8'bay)	1916	800-851		9 b2	Fort Chaffee
Elec Distrib Syst, 2ndary Lines	1918	SB 12	X	6a	Manual Cnstr Div
Elec Distrib Syst, Street Lighting	1918	SB 11	X	6a	Manual Cnstr Div
Electric Sub Station, 10x12	1909	4-936		6 a	Fort McPherson

Sorted by: BUILDING NAME

BUILDING	DATE	STD_PLAN	DRWNG	TYPE	INSTALLATION
Emg'ncy Whse C'prtmt & Group Plan	1918	SB 25	X	5 d1	Manual Cnstr Div
Emg'ncy Whse, Open Shed	1918	SB 27	X	5 d1	Manual Cnstr Div
Exchange	1916	700-297		7 f	Fort Chaffee
Field Bakery, Mobilization Camps	1916	16-16	X	5 c1	Manual for QMC
Field Officers Qtrs	1909	215		9 c2	Fort D.A. Russel
Field Officers Quarters	1905	145		9 c2	F.E. Warren AFB
Field Officers Quarters	1909	145-D		9 c2	F.E. Warren AFB
Field Officers Quarters	1910	145-F		9 c2	F.E. Warren AFB
Field Officers Quarters	1911	235-A		9 c2	F.E. Warren AFB
Field Officers Quarters	1932	625-1341	X	9 c2	Fort Riley, KS
Field Officers Quarters	1932	625-1301	X	9 c2	Marshall Field,
Field Officers Quarters	1933	625-1340	X	9 c2	Marshall Field,
Film Vault, size illegible	?	6217-127?		5 d1	Fort McPherson
Fire Station	1909	98-E		1 a	F.E. Warren AFB
Fire Station	1909	98-G		1 a	F.E. Warren AFB
Fire Station	1916	800-800		1 a	Fort Chaffee
Fire Station, 24'x77'	1918	620-341		1 a	Manual Cnstr Div
Fire Station, 31'x103	1918	620-447		1 a	Manual Cnstr Div
Fire Station, 31'x88'	1918	620-365		1 a	Manual Cnstr Div
Fire Station, 31'x88'	1918	620-441		1 a	Manual Cnstr Div
Fld. Office	1916	7093-451		1 c	Fort Chaffee
Fld. Office Water Stg. Tank	1916	7093-454.2		5 d1	Fort Chaffee
Four Family Apartment House	1930	625-808	X	9 c2	Fort Riley, KS
Four Set Civillian's Quarters	1909	82-N	X	9 c1	Fort Riley, KS
Frame Quarters for NCO	1928	Geo. E. Pond	X	9 c1	Fort Riley, KS
Garage for Ambulances, 22'x47'	1918	620-496		4 b	Manual Cnstr Div
Garage, 30' x var.	1918	620-511		9 d1	Manual Cnstr Div
Garage, 50' x var.	1918	620-301		9 d1	Manual Cnstr Div
Garage, 61x164	1918	6311-105		9 d1	Manual Cnstr Div
Garage, 65' x 108'	1918	620-322 & 323		9 d1	Manual Cnstr Div
Garage, closed, 70'x180'	1918	620-525		9 d1	Manual Cnstr Div
Garage, Mechanical Repair, 140x144	1918	6242-5		9 d1	Manual Cnstr Div
Garage, open, 50'xvar.	1918	620-524		9 d1	Manual Cnstr Div
Garage, Ordinance, 50xvar.	1918	652-17		9 d1	Manual Cnstr Div
Gas Instruction, 16x30	1918	6143-2		3 a	Manual Cnstr Div
Gas Sta. & Pump House	1916	800-601		10 c1	Fort Chaffee
Granary	1907	193	X	5 d1	Fort Riley, KS
Grease Rack & Insp. Rack	1916	800-1026		10 c2	Fort Chaffee
Guard Barrack, 30'x90'	1918	620-373-A		9 a2	Manual Cnstr Div
Guard House	1911	206		1 b	F.E. Warren AFB
Guard House, 60x85	1891	9		1 b	Fort McPherson
Guard House, Mobilization Camps	1916	16-11	X	1 b	Manual for QMC
Guard house, Regimental 20'x56'	1918	620-331		1 b	Manual Cnstr Div
Guard House, Type 1, 20x56	1918	652-214		1 b	Manual Cnstr Div
Guest House	1916	700-1290		9 a1	Fort Chaffee
Gymnasium	1940	6560-145 - 179		7 b	Fort D.A. Russel
Hay Shed	1909	102-G		10 b1	F.E. Warren AFB
Hay Shed	1926	102-F		10 b1	F.E. Warren AFB
Hay Shed, 60'x165'	1918	620-378		10 b1	Manual Cnstr Div
Heating Plant	1916	7093-501		6 a	Fort Chaffee
Hose House (Type A & B) 6'x7'	1918	620-445 & 446		6 b	Manual Cnstr Div
Hose House, 30x50	1898	Post		6 b	Fort McPherson

Sorted by: BUILDING NAME

BUILDING	DATE	STD_PLAN	DRWNG	TYPE	INSTALLATION
Hosp Corps Bar.	1908	1-729-S.P.S.		9 a2	Fort D.A. Russel
Hospital Corps Barracks	1912	276		9 a2	F.E. Warren AFB
Hospital Corps Barracks	1912	2-76		9 a2	Fort D.A. Russel
Hospital Sergant's Quarters	1905	Unknown		9 c1	F.E. Warren AFB
Hospital Typ Kitchen Layouts	1918	SB 14	X	4 b	Manual Cnstr Div
Hospital, Mobilization Camps	1916	16-13	X	4 b	Manual for QMC
Housing, 1 family, 24x30	1918	6309-150		9 c1	Manual Cnstr Div
Housing, 1 family, 24x32	1918	6309-190		9 c1	Manual Cnstr Div
Housing, 1 family, 24x36	1918	6309-180		9 c1	Manual Cnstr Div
Housing, 2 family, 25x36	1918	6309-200		9 c1	Manual Cnstr Div
Housing, 4 families, 38x53	1918	6309-121		9 c1	Manual Cnstr Div
Housing, Boarding, 27x38	1918	6309-160		9 c1	Manual Cnstr Div
Ice House	1910	196-A		6 b	F.E. Warren AFB
Ice Storage	1916	800-777		5 d1	Fort Chaffee
Incinerator	1916	414/43/330		6 c	Fort Chaffee
Incinerator	1938	A-13-1		6 c	Fort Riley, KS
Incinerator - trash only	1939	414-43-228		6 c	F.E. Warren AFB
Infirm./Dntl Dorm Bldg, 30'x88'	1918	620-310 & 311		4 a	Manual Cnstr Div
Infirmary	1916	800-1429		4 a	Fort Chaffee
Infirmary & Dental Ops Bldg. 30'x88	1918	620-307 & 308		4 a	Manual Cnstr Div
Infirmary - Large	1940	700-279		4 a	Fort Riley, KS
Infirmary - Medical, 30'x105'	1918	620-382		4 a	Manual Cnstr Div
Infirmary - Medical, 30'x112'	1918	620-383 & 384		4 a	Manual Cnstr Div
Infirmary - Medical, 30'x56'	1918	620-449		4 a	Manual Cnstr Div
Infirmary - Medical, 30'x63'	1918	620-302		4 a	Manual Cnstr Div
Infirmary - Medical, 30'x77'	1918	620-368 to 375		4 a	Manual Cnstr Div
Infirmary - Medical, 30'x98'	1918	620-392 & 393		4 a	Manual Cnstr Div
Infirmary - Medical, Addition, 24'x	1918	620-333		4 a	Manual Cnstr Div
Kit. & Dining Rm, 72 Men, Mob. Crmps	1916	15-6	X	9 b2	Manual for QMC
Kitchen & Mess, 24x100, 31x33	1930	6217-47 to 57		9 b2	Fort McPherson
Kitchen, Mobilization Camps	1916	16-7	X	9 b2	Manual for QMC
Lab Building for Vet Hosp	1907	A-14-16	X	8 a	Fort Riley, KS
Latrine, Mobilization Camps	1916	16-8	X	9 b1	Manual for QMC
Laundry	1911	234-B		5 c2	F.E. Warren AFB
Laundry	1911	243-B		5 c2	F.E. Warren AFB
Laundry	1916	800-1029		5 c2	Fort Chaffee
Laundry Steam Plant	1916	800-1619		5 c2	Fort Chaffee
Laundry, 36x108, 1-2,000 men	1918	633-140		5 c2	Manual Cnstr Div
Laundry, 72x216, 5-10,000 men	1918	633-130		5 c2	Manual Cnstr Div
Lav. w/out shwrs: 17x14, 17x21, 17x	1918	620-324		9 b1	Manual Cnstr Div
Lavatory	1916	700-285		9 b1	Fort Chaffee
Lavatory w/showers, 14x14, 14x20	1918	620-349		9 b1	Manual Cnstr Div
Lavatory w/showers, 20x21, x28	1918	620-348		9 b1	Manual Cnstr Div
Lavatory w/showers, 20x35	1918	620-347		9 b1	Manual Cnstr Div
Lavatory w/showers, 20x42	1918	620-346		9 b1	Manual Cnstr Div
Lavatory w/showers, 20x49	1918	620-345		9 b1	Manual Cnstr Div
Lavatory w/showers, 20x50	1918	620-523		9 b1	Manual Cnstr Div
Layout: Head House	1918	SGO-A1	X	4 b	Manual Cnstr Div
Layout: Hospital	1918	SGO-A	X	4 b	Manual Cnstr Div
Lecture Hall, 51x77	1918	608-104		7 a	Manual Cnstr Div
Liberty Theatre, 60x120	1918	620-499 & 500		7 g	Manual Cnstr Div
Light Battery Gun Shed	1905	104		5 d2	F.E. Warren AFB

Sorted by: BUILDING NAME

BUILDING	DATE	STD_PLAN	DRWNG	TYPE	INSTALLATION
Light Battery Gun Shed	1908	104-F		5 d2	F.E. Warren AFB
Magazine, 12x15, brick	1893	46		5 d2	Fort McPherson
Magazine, 20'x20'	1918	620-370		5 d2	Manual Cnstr Div
Magazine, 24'x60'	1918	620-371		5 d2	Manual Cnstr Div
Magazine, Black P'wdr, 16x22	1918	6196-104		5 d2	Manual Cnstr Div
Magazine, brick w/corr steel rf, 10	1918	620-452		5 d2	Manual Cnstr Div
Magazine, Post Ordnance	1934	19-2-70	X	5 d2	Fort Lewis, WA
Magazine, Smokeless powdr, 32x96	1918	652-146		5 d2	Manual Cnstr Div
Magazine, Type 1 & Type 2	1918	SB 23	X	5 d2	Manual Cnstr Div
Magazine, Type 10, 49x208	1918	652-179		5 d2	Manual Cnstr Div
Magazine, Type 11, H.E. 26x42	1918	652-180		5 d2	Manual Cnstr Div
Magazine, Type 12, 26x42	1918	652-31		5 d2	Manual Cnstr Div
Magazine, Type 13, 26x42	1918	652-169		5 d2	Manual Cnstr Div
Magazines igloo type	1916	642-535		5 d2	Fort Chaffee
Magazines igloo type	1916	652-535		5 d2	Fort Chaffee
Meat Inspection Platform, 10'x66'	1918	620-429		9 b2	Manual Cnstr Div
Med Dtchmnt Bar (and 6560-140--142)	1939	621-1325--1346		9 a2	F.E. Warren AFB
Med. Detachment Admin. Bldg.	1916	800-A101210		1 c	Fort Chaffee
Med. Detachment Barracks	1916	700-1204		9 a2	Fort Chaffee
Med. Detachment Barracks	1939	6560-140 - 142		9 a2	Fort D.A. Russel
Med. Detachment Recr.	1916	800-459		7 a	Fort Chaffee
Medical Detachment Bar	1939	6560-140--142		9 a2	F.E. Warren AFB
Medical Detachment Mess	1916	700-446		9 b2	Fort Chaffee
Mess Building, 30x120 , x132, x144	1918	620-442		9 b2	Manual Cnstr Div
Mess Building, Mobilization Camps	1916	16-6	X	9 b2	Manual for QMC
Mess Hall, 144x177, 800 men	1893	42		9 b2	Fort McPherson
Mess Patients	1916	700-44+A476		9 b2	Fort Chaffee
Morgue	1916	800-1454		4.b	Fort Chaffee
Motor Repair Shop	1916	700-1390		10 c2	Fort Chaffee
Motor Repair Shop	1916	700+A42-374		10 c2	Fort Chaffee
Motor Repair Shop	1916	800-606		10 c2	Fort Chaffee
Motor School	1916	700-374		10 c2	Fort Chaffee
N.C.O. Quarters	1909	82-K		9 c1	F.E. Warren AFB
NCO Barracks, Mobilization Camps	1916	16-4	X	9 a2	Manual for QMC
NCO Double Quarters	1930	625-541	X	9 c1	Fort Riley, KS
NCO Garages	1940	A-20-7	X	9 d1	Fort Riley, KS
NCO Quarters - type c - brick	1932	625-1556	X	9 c1	Fort Riley, KS
Non-Commissioned Officers Quarters	N.D.	Geo. E. Pond	X	9 c1	Fort Riley, KS
Northern & Southern Constr Zones	1918	620-320-2-182	X	11a	Manual Cnstr Div
Nurses Quarters	1906	152-E		9 a1	F.E. Warren AFB
Nurses Quarters, 13 nurses	1933	707-102 to 107		9 a1	Fort McPherson
Nurses Recreation Room	1916	800-451		7 a	Fort Chaffee
Nurses' Mess	1916	700-451		9 b2	Fort Chaffee
Nurses' Quarters	1916	700-1240		9 a1	Fort Chaffee
Officer's Qtrs, 20x21 types A,B,C	1918	620-369		9 c2	Manual Cnstr Div
Officers Mess	1916	700-1127		9 b2	Fort Chaffee
Officers Quarters	1888	(illegible)2		9 c2	F.E. Warren AFB
Officers Quarters	1910	120-H		9 c2	F.E. Warren AFB
Officers Quarters	1910	142-D		9 c2	F.E. Warren AFB
Officers Quarters	1902	SPL 3-381		9 c2	Fort Riley, KS
Officers Quarters 4 Officers	1909	237-A	X	9 c2	Fort Riley, KS
Officers Quarters, 20x28	1918	620-344		9 c2	Manual Cnstr Div

Sorted by: BUILDING NAME

BUILDING	DATE	STD_PLAN	DRWNG	TYPE	INSTALLATION
Officers Quarters, 20x49	1918	620-337		9 c2	Manual Cnstr Div
Officers Quarters, 20xvar.	1918	620-363		9 c2	Manual Cnstr D
Officers Quarters, 20xvar.	1918	620-364		9 c2	Manual Cnstr Div
Officers Quarters, 30xvar.	1918	620-343		9 c2	Manual Cnstr Div
Officers Quarters, 30xvar.	1918	620-354		9 c2	Manual Cnstr Div
Officers Quarters, Lge, Mob. Camps	1916	16-2	X	9 a1	Manual for QMC
Officers Quarters, Sml, Mob. Camps	1916	16-3	X	9 a1	Manual for QMC
Officers' Mess	1916	700-450		9 b2	Fort Chaffee
Officers' Quarters	1916	700-1257		9 c2	Fort Chaffee
Officers' Quarters	1916	800-307		9 c2	Fort Chaffee
Officers' Club	1916	800-809		7 d	Fort Chaffee
Officers' Quarters	1916	700-1254		9 c2	Fort Chaffee
Officers Quarters	1916	800-306		9 c2	Fort Chaffee
Oil House 25x 49'	1916	700-323		6 a	Fort Chaffee
Oil house, 20x30	1918	620-396		6 a	Manual Cnstr Div
Oil Shed	1916	700-384		6 a	Fort Chaffee
Operations Building	1940	613-9365		1 c	Marshall Field
Operations Building	1940	6139-366		1 c	Marshall Field,
Ordnance Repair Shop 30x106	1918	620-508		5 a	Manual Cnstr Div
Ordnance Shop Boiler House	1916	652-423		5 a	Fort Chaffee
Ordnance Shop w/crane	1916	652-419		5 a	Fort Chaffee
Ordnance Store House	N.D.	Geo. E. Pond	X	5 d2	Fort Riley, KS
Ordnance Storehouse, 30x50	1897	103-A		5 d1	Fort McPherson
Outhouse for Cavalry Barracks	N.D.	Geo. E. Pond	X	9 b1	Fort Riley, KS
Packing & Crating shop	1938	A-8-12	X	5 a	Fort Riley, KS
Paint Oil & Dope House	1940	702-118	X	5 d1	Marshall Field,
Physiotherapy	1916	700-348		4 b	Fort Chaffee
Post & Telegraph Office	1907	177		1 d	F.E. Warren AFB
Post Bakery	1903	1-1180		5 c1	F.E. Warren AFB
Post Exchange	1905	158		7 f	F.E. Warren AFB
Post Exchange	1916	800-1412		7 f	Fort Chaffee
Post Exchange & Gymnasium	1906	174	X	7 a	Fort Riley, KS
Post Exchange & Gymnasium	N.D.	Geo. E. Pond	X	7 a	Fort Riley, KS
Post Exchange, 32x91	1918	620-359		7 f	Manual Cnstr Div
Post Exchange, Mobilization Camps	1916	16-15	X	7 f	Manual for QMC
Post Guard House	1901	30-C		1 b	F.E. Warren AFB
Post Headquarters	1909	1-729 S.P.S.		1 c	F.E. Warren AFB
Post Office	1916	800-217		1 d	Fort Chaffee
Post Office Building, 32x51	1918	620-374		1 d	Manual Cnstr Div
Post Office, Type PO-1	1937	700-298	X	1 d	Fort Riley, KS
Powder Magazine	1910	263		5 d2	F.E. Warren AFB
Primer & Fuse house #1, 32x96	1918	652-173		5 d2	Manual Cnstr Div
Primer & Fuse house #2, 32x96	1918	652-174		5 d2	Manual Cnstr Div
Prisoner's Barrack & Yard, 30'x9	1918	620-373		9 a2	Manual Cnstr Div
Prisoner's Barracks	1916	800-443		9 a2	Fort Chaffee
Proposed Administration Building	N.D.	Geo. E. Pond		1 c	Fort Riley, KS
Proposed Field Officers Quarters	N.D.	Geo. E. Pond	X	9 c2	Fort Riley, KS
Pump House (& N.C.O. Quarters)	1905	132-E		6 b	F.E. Warren AFB
Pyrotech Plant Type 1 & 2, 30x161	1918	652-157		5 b	Manual Cnstr Div
Pyrotech Plant Type D, 20x35	1918	652-152		5 b	Manual Cnstr Di
Pyrotech Plant Type J & J1, 20x35	1918	652-158		5 b	Manual Cnstr Div
Q.M. Barracks for M.T.	1900	53-D		9 a2	F.E. Warren AFB

Sorted by: BUILDING NAME

BUILDING	DATE	STD_PLAN	DRWNG	TYPE	INSTALLATION
Q.M. Forage Storehouse	1908	53-A		5 d1	F.E. Warren AFB
Q.M. Gas Station	1932	A-5-21	X	10 c1	Fort Riley, KS
Q.M. Store House, Artillery	1909	198		5 d2	F.E. Warren AFB
Q.M. Utility Shop	1916	800-603		5 a	Fort Chaffee
Quartermaster Stable, 129x67	1908	139-H		10 b1	Fort McPherson
Quartermaster Stable, 145x67	1910	139-L		10 b1	Fort McPherson
Quarters for Civilian Employees	1909	258	X	9 c1	Fort Riley, KS
Quarters for Commanding Officer	N.D.	Geo. E. Pond	X	9 c2	Fort Riley, KS
Quarters for Field Officer	1905	145-D	X	9 c2	Fort Riley, KS
Quarters for Packers	N.D.	A-2-17	X	9 a2	Fort Riley, KS
Quarters for Steam Heating Engineer	N.D.	Geo. E. Pond	X	9 c1	Fort Riley, KS
Quarters for Two Lieutenants	1907	120-H	X	9 c2	Fort Riley, KS
Quarters, no designation	1938	A-4-9	X	9 c2	Fort Riley, KS
Quarters, no designation	1939	A-2-3	X	9 c1	Fort Riley, KS
Quarters, no designation	1939	A-4-7	X	9 c2	Fort Riley, KS
Radio Range Bldg.	1916	800-905		2 a	Fort Chaffee
Recreation Bldg.	1916	800-460		7 a	Fort Chaffee
Recreation Bldg. Patients	1916	700-520		4 b	Fort Chaffee
Recreational Bldg.	1916	700-310		7 a	Fort Chaffee
Recruit Exam. Bldg / Shop	1918	SB 19	X	4 a	Manual Cnstr Div
Refrigerating & Ice Making Plant	1918	SB 28	X	5 b	Manual Cnstr Div
Refrigeration Plant, 20x72	1918	620-471 & 472		9 b2	Manual Cnstr Div
Refrigeration Cooling Tower,	1918	620-473		9 b2	Manual Cnstr Div
Rendering Plant, 32x48	1918	620-435		5 b	Manual Cnstr Div
Revised Plan of Engineer Garage	1937	A-20-12	X	9 d1	Fort Riley, KS
Rm. & Storage Bays	1916	800-607		5 d1	Fort Chaffee
Road Cross Section, Typical	1918	LA-1	X	10c2	Manual Cnstr Div
Road Cross Sections, Typical	1918	LA-2	X	10c2	Manual Cnstr Div
Roadbed Sectons, Railways	1918	RR-6	X	10 d2	Manual Cnstr Div
Salvage Warehouse	1916	800-652		5 d1	Fort Chaffee
Service Club	1916	700-1775		7 d	Fort Chaffee
Sewage Treat. Plnt, Cntrl Hse	1942	408-204	X	6 b	Fort Riley, KS
Shed - Wagon or Gun, 29xvar.	1918	620-332		5 d2	Manual Cnstr Div
Shed, Dock, 60x122	1918	652-165		5 d2	Manual Cnstr Div
Shop - Utilities	1937	700-317	X	5 a	Fort Riley, KS
Shop Building	1916	407	X	5 a	Fort Riley, KS
Shop, 20x36	1918	620-372		5 a	Manual Cnstr Div
Shop, Clothing etc 30x102	1918	620-381		5 a	Manual Cnstr Div
Shop, Clothing, etc 28x132, 28x162	1918	620-467		5 a	Manual Cnstr Div
Shop, Clothing, etc, 60x100	1918	620-437		5 a	Manual Cnstr Div
Shop, Cot repair, 40x36	1918	620-436		5 a	Manual Cnstr Div
Shop, Motor Repair, 60x130	1918	620-387 & 388		10 c2	Manual Cnstr Div
Shop, Motor Repair, 75x96	1918	620-478 & 479		10 c2	Manual Cnstr Div
Shop, Ordnance Repair, 30x80	1918	652-19		5 a	Manual Cnstr Div
Shop, QMaster, 2 bldgs each, 36x106	1918	620-390		5 a	Manual Cnstr Div
Shop, Tent Repair, 40x60	1918	620-440		5 a	Manual Cnstr Div
Shop, Tent Treating, 36x40	1918	620-439		5 a	Manual Cnstr Div
Shower shelter & wash house, 20x80	1918	620-451		9 b1	Manual Cnstr Div
Sm Finance. Bldg.	1916	800-219		1 c	Fort Chaffee
Sports Arena	1916	800-465		7 b	Fort Chaffee
Sta. HQ. Office	1916	800-214		1 c	Fort Chaffee
Stable	1938	A-14-4		10 b1	Fort Riley, KS

Sorted by: BUILDING NAME

BUILDING	DATE	STD_PLAN	DRWNG	TYPE	INSTALLATION
Stable - closed, 29xvar.	1918	SB 17	X	10 b1	Manual Cnstr Div
Stable - open 24xvar.	1918	620-376		10 b1	Manual Cnstr D
Stable - School of Equitation	1939	A-14-12	X	10 b1	Fort Riley, KS
Stable for Inf. & Officers Mounts	1908	139-Q		10 b1	F.E. Warren AFB
Stable Guard & Shops	1909	39-N		10 b1	F.E. Warren AFB
Stable Guard & shops	1911	39-Q		10 b1	F.E. Warren AFB
Stable Guard , 20x21	1918	620-395		5 a	Manual Cnstr Div
Stable Guard House	1909	39-L		10 b1	F.E. Warren AFB
Stable Guard House	lleg	39-C		10 b1	Fort Riley, KS
Stable Guard House & Shops	1909	39-G		10 b1	F.E. Warren AFB
Stable Guard House, DBL Building	1905	39-C	X	10 b1	F.E. Warren AFB
Stables	1938	14-7-illegible	X	10 b1	Fort Riley, KS
Stables	1938	14-9-illegible	X	10 b1	Fort Riley, KS
Standard All Steel Airplane Hangar	?	6342-158 ?	X	10 a1	Chief of Air Servc
Standard Incinerator	1918	SB 8	X	6 c	Manual Cnstr Div
Standard Laundry, 10-20,000 men	1918	SB 20		5 c2	Manual Cnstr Div
Standard Railway Trestle	1918	RR-1	X	10 d1	Manual Cnstr Div
Standard Steel & Wood Hangars	1919	SB 9	X	10 a1	Manual Cnstr Div
Station QM Office Boiler Hs.	1916	800-201		6 a	Fort Chaffee
Std. Railway Coal Trestle	1918	RR-2	X	10 d1	Manual Cnstr Div
Std. Timber Coal Pocket	1918	RR-3	X	10 d1	Manual Cnstr Div
Std. Trestle Bumper, Railways	1918	RR-5	X	10 d1	Manual Cnstr Div
Storage Depot/admin Bldg, 140x160	1918	6271-7		5 d1	Manual Cnstr Div
Storage, Vehicles # 3, 161xvar	1918	652-188		10 c2	Manual Cnstr Div
Storage, Vehicles, #1, 113x513	1918	652-43		10 c2	Manual Cnstr Div
Store House, Divisional, 60x168	1918	SB 16	X	5 d1	Manual Cnstr Div
Store House, Mobilization Camps	1916	16-12	X	5 d1	Manual for QMC
Store House, Regmtl, 20xvar.	1918	620-318		5 d1	Manual Cnstr Div
Store House, Salvage, 60x168	1918	620-412 & 413		5 d1	Manual Cnstr Div
Storehouse	1916	700-461		5 d1	Fort Chaffee
Storehouse	1916	800-663		5 d1	Fort Chaffee
Storehouse	1916	800-664		5 d1	Fort Chaffee
Storehouse, General, #1, 161x501	1918	652-41		5 d1	Manual Cnstr Div
Storehouse, General, #2	1918	652-74		5 d1	Manual Cnstr Div
Subsistence Storehouse	1897	106		5 d1	Fort McPherson
Teamsters Quarters	1910	258		9 a2	F.E. Warren AFB
Tel. & TeL Bldg.	1916	800-907		2 b	Fort Chaffee
Tel. & Teleg. Bldg, 20x70	1918	620-328		2 b	Manual Cnstr Div
Telegraph office & Quarters, 20x110	1918	620-418		2 b	Manual Cnstr Div
Temporary Bldgs for Mob Camps	1916	16-1	X	11 a	Manual for QMC
Terminal General Plan	1918	RR-7	X	11a	Manual Cnstr Div
Terminals General Plans	1918	RR-8	X	11a	Manual Cnstr Div
Theatre w/Stage	1916	700-1212.1		7 g	Fort Chaffee
Theatre, Class a, 120x187	1918	608-24		7 g	Manual Cnstr Div
Theatre, Liberty, Class D	1918	608-31to34&106		7 g	Manual Cnstr Div
Transformer Sta. Type 1, 20x36	1918	652-81		6 a	Manual Cnstr Div
Trestle, Coal	1918	RR 9	X	10 d1	Fort Lewis, WA
Turnout & Crossover, Railways	1918	RR-4	X	10 d2	Manual Cnstr Div
Typ L'scp Pl'tg: CO & Dbl CO Qtrs	1935	630-100	X	11 a	Office of QMG
Typ Em'gncy Str'g Whse Toilet Rms	1918	SB 10	X	5 d1	Manual Cnstr Div
Typ Hospital Kitchen Layouts	1918	SB 13	X	9 b2	Manual Cnstr Div
Typ L'scp Pl'tg: Th'tre, Hosp, Chpl	1935	630-103	X	11 a	Office of QMG

Sorted by: BUILDING NAME

BUILDING	DATE	STD_PLAN	DRWNG	TYPE	INSTALLATION
Typ. Em'gncy Str'g Whse Admin Bldg	1918	SB 26	X	5 d1	Manual Cnstr Div
Typ. Hosp Phys Thrpy & Amusmnt Hall	1918	SGO-S & T	X	4 b	Manual Cnstr Div
Typ. L'scp Pl'tg: HQ, Admin, BOQ	1935	630-Illegible	X	11 a	Office of QMG
Typical 1 Story Building	1918	SB 1	X	11a	Manual Cnstr Div
Typical 2 Story Building	1918	SB 2	X	11a	Manual Cnstr Div
Typical 2 Story Officers Qtrs	1918	SB 5	X	9 c2	Manual Cnstr Div
Typical 2 Sty Building, Details	1918	SB 3	X	11a	Manual Cnstr Div
Typical Barracks, 66 Men	1918	SB 4	X	9 a2	Manual Cnstr Div
Typical Dry Cleaning Plant	1930	633-165		5 c2	Fort Riley, KS
Typical Hosp Admin Bldg	1918	SGO-B	X	4 b	Manual Cnstr Div
Typical Hosp General Mess & Kitchen	1918	SGO-I1 & I32	X	4 b	Manual Cnstr Div
Typical Hosp General Mess & Kitchen	1918	SGO-I28	X	4 b	Manual Cnstr Div
Typical Hosp Laboratory Bldg	1918	SGO-F	X	4 b	Manual Cnstr Div
Typical Hosp Operating Pavillion	1918	SGO-G	X	4 b	Manual Cnstr Div
Typical Hosp Receiving Ward	1918	SGO-J	X	4 b	Manual Cnstr Div
Typical Hosp Single Wards	1918	SGO-K1	X	4 b	Manual Cnstr Div
Typical Hosp Single Wards	1918	SGO-K34	X	4 b	Manual Cnstr Div
Typical Hosp Single Wards	1918	SGO-K35	X	4 b	Manual Cnstr Div
Typical Lavatories	1918	SB 6	X	9 b1	Manual Cnstr Div
Typical Lavatories Details	1918	SB 7	X	9 b1	Manual Cnstr Div
Typical Mess Buildings	1918	SB 15	X	9 b2	Manual Cnstr Div
Typical Street Tree Planting	1935	630-102	X	11 a	Office of QMG
Unit Guardhouse	1916	700-260		1 b	Fort Chaffee
Unit Guardhouse	1916	700-260.1		1 b	Fort Chaffee
Utility Office	1931	59-U		6 b	F.E. Warren AFB
Vehicle Shed	1910	60-H		10 c2	F.E. Warren AFB
Vehicle Shelter, Mobilization Camps	1916	16-18	X	10 c2	Manual for QMC
Veterinary Hospital	1908	166		10 b1	F.E. Warren AFB
Wagon Shed	1906	60-G		10 b1	F.E. Warren AFB
War Dept Theater	1939	608-360 - 366		7 g	Fort D.A. Russel
War Dept Theatre	1939	608-360 to 366		7 g	F.E. Warren AFB
War Dept Theatre, 85x49	1939	6217-105 to 107		7 g	Fort McPherson
Ward Building, Mobilization Camps	1916	16-14	X	4 b	Manual for QMC
Ward Combination	1916	700-463		4 b	Fort Chaffee
Warehouse (Insulated)	1916	800-654		5 d1	Fort Chaffee
Warehouse, Clothing, 60x100	1918	620-385 & 386		5 d1	Manual Cnstr Div
Waste & Transfer Station, 20x130	1918	620-432		6 c	Manual Cnstr Div
Water Tank (tower)	1903	68-C		6 b	F.E. Warren AFB
Welfare Bldg, 84x96	1918	6399-120		1 c	Manual Cnstr Div
X-Ray Building	1916	700-462		4 b	Fort Chaffee

Sorted by: DATE

INSTALLATION	BUILDING	DATE	STD_PLAN	DRWNG	TYPE
Chief of Air Ser	Standard All Steel Airplane Hangar	None	6342-158 ?	X	10 a1
Fort McPherson	Film Vault, size illegible	None	6217-127?		5 d1
Fort Riley, KS	Stable Guard House	lleg	39-C		10 b1
F.E. Warren AFB	Double Set N.C.S.O. Quarters	1885	82-D		9 c1
F.E. Warren AFB	Officers Quarters	1888	(Illegible)2		9 c2
Fort McPherson	Guard House, 60x85	1891	9		1 b
Fort McPherson	Magazine, 12x15, brick	1893	46		5 d2
Fort McPherson	Mess Hall, 144x177, 800 men	1893	42		9 b2
Fort Riley, KS	Cavalry Stable Guard Building	1896	George Ruhlen	X	1 b
Fort Riley, KS	Artillery Barracks, 80 Men	1896	Geo. E. Pond	X	9 a2
Fort McPherson	Ordnance Storehouse, 30x50	1897	103-A		5 d1
Fort McPherson	Subsistence Storehouse	1897	106		5 d1
Fort McPherson	Hose House, 30x50	1898	Post		6 b
F.E. Warren AFB	Q.M. Barracks for M.T.	1900	53-D		9 a2
F.E. Warren AFB	Post Guard House	1901	30-C		1 b
Fort Riley, KS	Bakery	1902	49H	X	5 c1
Fort Riley, KS	B.O.Q	1902	152	X	9 a1
Fort Riley, KS	Cavalry Barracks	1902	75	X	9 a2
Fort Riley, KS	Double Quarters for Officer	1902	SPL 3-368	X	9 c2
Fort Riley, KS	Officers Quarters	1902	SPL 3-381		9 c2
F.E. Warren AFB	Post Bakery	1903	1-1180		5 c1
F.E. Warren AFB	Water Tank (tower)	1903	68-C		6 b
F.E. Warren AFB	C.O.'s Quarters	1903	95-A		9 c2
F.E. Warren AFB	Artillery Stables	1904	139-C		10 b1
F.E. Warren AFB	Artillery Workshop	1904	59-K		5 a
F.E. Warren AFB	Coal Shed	1904	67-B		5 d1
Fort McPherson	BOQ, 33x140, 33x45, 12x33	1904	152-B	X	9 a1
F.E. Warren AFB	Artillery Barracks	1904	150		9 a2
Fort McPherson	Double barracks, 39x150	1904	75-G		9 a2
F.E. Warren AFB	Stable Guard House, DBL Building	1905	39-C	X	10 b1
Fort Riley, KS	Commissary Store House	1905	A-19-1	X	5 d1
F.E. Warren AFB	Light Battery Gun Shed	1905	104		5 d2
Fort McPherson	Boiler/Pump House	1905	132-H		6 a
F.E. Warren AFB	Pump House (& N.C.O. Quarters)	1905	132-E		6 b
F.E. Warren AFB	Post Exchange	1905	158		7 f
F.E. Warren AFB	Hospital Sergant's Quarters	1905	Unknown		9 c1
F.E. Warren AFB	Double Set Officer's Quarters	1905	120-C		9 c2
F.E. Warren AFB	Double Set Officers Quarters	1905	120-D		9 c2
F.E. Warren AFB	Field Officers Quarters	1905	145		9 c2

Sorted by: DATE

INSTALLATION	BUILDING	DATE	STD_PLAN	DRWNG	TYPE
F.E. Warren AFB	Double Set Officer's Quarters	1905	90		9 c2
Fort Riley, KS	Quarters for Field Officer	1905	145-D	X	9 c2
F.E. Warren AFB	Cavalry Stable	1906	139		10 b1
F.E. Warren AFB	Wagon Shed	1906	60-G		10 b1
Fort Riley, KS	Post Exchange & Gymnasium	1906	174	X	7 a
F.E. Warren AFB	Nurses Quarters	1906	152-E		9 a1
Fort McPherson	Dbl Mess Hall & Kit, 140x42,	1906	93-K		9 b2
F.E. Warren AFB	Double Officers Quarters	1906	142-A		9 c2
F.E. Warren AFB	Post & Telegraph Office	1907	177		1 d
F.E. Warren AFB	Cavalry Drill Hall	1907	97-A		3 b
Fort Riley, KS	Granary	1907	193	X	5 d1
Fort Riley, KS	Lab Building for Vet Hosp	1907	A-14-16	X	8 a
Fort Riley, KS	Band Barracks	1907	61-F	X	9 a2
Fort Riley, KS	Quarters for Two Lieutanants	1907	120-H	X	9 c2
Fort Riley, KS	Artillery Guard House	1908	A-13-9	X	1 b
F.E. Warren AFB	Artillery or Infantry Stables	1908	139-K		10 b1
F.E. Warren AFB	Stable for Inf. & Officers Mounts	1908	139-Q		10 b1
F.E. Warren AFB	Veterinary Hospital	1908	166		10 b1
Fort McPherson	Quartermaster Stable, 129x67	1908	139-H		10 b1
F.E. Warren AFB	Artillery Shop	1908	59-V		5 a
F.E. Warren AFB	Q.M. Forage Storehouse	1908	53-A		5 d1
F.E. Warren AFB	Light Battery Gun Shed	1908	104-F		5 d2
F.E. Warren AFB	Crematory	1908	1-620-B		6 c
Fort D.A. Russel	Crematory	1908	1-620-B		6 c
F.E. Warren AFB	Bachelor Officers Quarters	1908	152-G		9 a1
F.E. Warren AFB	Artillery Barracks	1908	181		9 a2
Fort D.A. Russel	Hosp Corps Bar.	1908	1-729-S.P.S.		9 a2
F.E. Warren AFB	Fire Station	1909	98-E		1 a
F.E. Warren AFB	Fire Station	1909	98-G		1 a
F.E. Warren AFB	Post Headquarters	1909	1-729 S.P.S.		1 c
F.E. Warren AFB	Hay Shed	1909	102-G		10 b1
F.E. Warren AFB	Stable Guard House & Shops	1909	39-G		10 b1
F.E. Warren AFB	Stable Guard House	1909	39-L		10 b1
F.E. Warren AFB	Stable Guard & Shops	1909	39-N		10 b1
F.E. Warren AFB	Dispensary (Cavalry)	1909	247		4 a
F.E. Warren AFB	Cavalry Granary	1909	193-A		5 d1
F.E. Warren AFB	Coal Shed	1909	67-J		5 d1
F.E. Warren AFB	Q.M. Store House, Artillery	1909	198		5 d2
F.E. Warren AFB	Artillery Gun Shed	1909	209		5 d2
Fort McPherson	Electric Sub Station, 10x12	1909	4-936		6 a
F.E. Warren AFB	Cavalry Band Barracks	1909	61-F		9 a2
F.E. Warren AFB	N.C.O. Quarters	1909	82-K		9 c1
Fort Riley, KS	Quarters for Civilian Employees	1909	258	X	9 c1
Fort Riley, KS	Four Set Civillian's Quarters	1909	82-N	X	9 c1
F.E. Warren AFB	Double Lieutenants Quarters	1909	120-F		9 c2
F.E. Warren AFB	Double Officers Quarters	1909	142-B		9 c2
F.E. Warren AFB	Field Officers Quarters	1909	145-D		9 c2
Fort D.A. Russel	Field Officers Qtrs	1909	215		9 c2

Sorted by: DATE

INSTALLATION	BUILDING	DATE	STD_PLAN	DRWNG	TYPE
Fort Riley, KS	Officers Quarters 4 Officers	1909	237-A	X	9 c2
Fort McPherson	Quartermaster Stable, 145x67	1910	139-L		10 b1
F.E. Warren AFB	Vehicle Shed	1910	60-H		10 c2
F.E. Warren AFB	Ammunition Storehouse	1910	262		5 d2
F.E. Warren AFB	Powder Magazine	1910	263		5 d2
F.E. Warren AFB	Ice House	1910	196-A		6 b
F.E. Warren AFB	Artillery Exchange	1910	122-B		7 f
F.E. Warren AFB	Cavalry Post Exchange	1910	122-b		7 f
F.E. Warren AFB	Commissary Building	1910	186		7 f
F.E. Warren AFB	Bachelor Officers Quarters	1910	152-L		9 a1
F.E. Warren AFB	Teamsters Quarters	1910	258		9 a2
F.E. Warren AFB	Cavalry Barracks	1910	75-M		9 a2
F.E. Warren AFB	Officers Quarters	1910	120-H		9 c2
F.E. Warren AFB	Officers Quarters	1910	142-D		9 c2
F.E. Warren AFB	Field Officers Quarters	1910	145-F		9 c2
F.E. Warren AFB	Guard House	1911	206		1 b
F.E. Warren AFB	Administration Building	1911	112-F		1 c
F.E. Warren AFB	Admin Building (Artillery)	1911	122-F		1 c
F.E. Warren AFB	Stable Guard & shops	1911	39-Q		10 b1
F.E. Warren AFB	Laundry	1911	234-B		5 c2
F.E. Warren AFB	Laundry	1911	243-B		5 c2
F.E. Warren AFB	Band Stand, Cavalry & Artillery	1911	64-B		7 g
F.E. Warren AFB	Civillian Employees Quarters	1911	82-P		9 c1
F.E. Warren AFB	Field Officers Quarters	1911	235-A		9 c2
F.E. Warren AFB	4 Set Officers Quarters	1911	237-B		9 c2
Fort D.A. Russel	4-Set Officers Qtrs	1911	267-B		9 c2
F.E. Warren AFB	Hospital Corps Barracks	1912	276		9 a2
Fort D.A. Russel	Hospital Corps Barracks	1912	2-76		9 a2
Fort Chaffee	Fire Station	1916	800-800		1 a
Fort Chaffee	Unit Guardhouse	1916	700-260		1 b
Fort Chaffee	Unit Guardhouse	1916	700-260.1		1 b
Manual for QMC	Guard House, Mobilization Camps	1916	16-11	X	1 b
Fort Chaffee	Fld. Office	1916	7093-451		1 c
Fort Chaffee	Administration Bldg. (Hosp.)	1916	800-1417		1 c
Fort Chaffee	Administration Bldg.	1916	800-204		1 c
Fort Chaffee	Sta. HQ. Office	1916	800-214		1 c
Fort Chaffee	Sm Finance. Bldg.	1916	800-219		1 c
Fort Chaffee	Med. Detachment Admin. Bldg.	1916	800-A101210		1 c
Manual for QMC	Admin Building, Mobilization Camps	1916	16-10	X	1 c
Fort Chaffee	Post Office	1916	800-217		1 d
Manual for QMC	Animal Shelter, Mobilization Camps	1916	16-17	X	10 b1
Fort Chaffee	Gas Sta. & Pump House	1916	800-601		10 c1
Fort Chaffee	Motor Repair Shop	1916	700-1390		10 c2
Fort Chaffee	Motor School	1916	700-374		10 c2
Fort Chaffee	Motor Repair Shop	1916	700+A42-374		10 c2
Fort Chaffee	Grease Rack & Insp. Rack	1916	800-1026		10 c2
Fort Chaffee	Motor Repair Shop	1916	800-606		10 c2
Fort Chaffee	Dispatching House	1916	800-661		10 c2

Sorted by: DATE

INSTALLATION	BUILDING	DATE	STD_PLAN	DRWNG	TYPE
Manual for QMC	Vehicle Shelter, Mobilization Camps	1916	16-18	X	10 c2
Manual for QMC	Temporary Bldgs for Mob Camps	1916	16-1	X	11 b
Fort Chaffee	Radio Range Bldg.	1916	800-905		2 a
Fort Chaffee	Tel. & TeL Blg.	1916	800-907		2 b
Fort Chaffee	Dental Clinic	1916	700-467		4 a
Fort Chaffee	Clinic	1916	700-476		4 a
Fort Chaffee	Clinic	1916	700-484		4 a
Fort Chaffee	Infirmary	1916	800-1429		4 a
Fort Chaffee	Dental Clinic	1916	800-1445		4 a
Fort Chaffee	Clinic	1916	800-1513		4 a
Fort Chaffee	Physiotherapy	1916	700-348		4 b
Fort Chaffee	X-Ray Building	1916	700-462		4 b
Fort Chaffee	Ward Combination	1916	700-463		4 b
Fort Chaffee	Recreation Bldg. Patients	1916	700-520		4 b
Fort Chaffee	Morgue	1916	800-1454		4 b
Fort Chaffee	Detention Ward	1916	800.-1424		4 b
Manual for QMC	Hospital, Mobilization Camps	1916	16-13	X	4 b
Manual for QMC	Ward Building, Mobilization Camps	1916	16-14	X	4 b
Fort Chaffee	Ordnance Shop w/crane	1916	652-419		5 a
Fort Chaffee	Ordnance Shop Boiler House	1916	652-423		5 a
Fort Chaffee	C & E Repair Shop	1916	800-1000		5 a
Fort Chaffee	Q.M. Utility Shop	1916	800-603		5 a
Fort Riley, KS	Shop Building	1916	407	X	5 a
Fort Chaffee	Bakery	1916	800-682		5 c1
Manual for QMC	Field Bakery, Mobilization Camps	1916	16-16	X	5 c1
Fort Chaffee	Laundry	1916	800-1029		5 c2
Fort Chaffee	Laundry Steam Plant	1916	800-1619		5 c2
Fort Chaffee	Cold Storage	1916	700-1265R		5 d1
Fort Chaffee	Storehouse	1916	700-461		5 d1
Fort Chaffee	Fld. Office Water Stg. Tank	1916	7093-454.2		5 d1
Fort Chaffee	Rm. & Storage Bays	1916	800-607		5 d1
Fort Chaffee	Salvage Warehouse	1916	800-652		5 d1
Fort Chaffee	Warehouse (Insulated)	1916	800-654		5 d1
Fort Chaffee	Storehouse	1916	800-663		5 d1
Fort Chaffee	Storehouse	1916	800-664		5 d1
Fort Chaffee	Ice Storage	1916	800-777		5 d1
Manual for QMC	Store House, Mobilization Camps	1916	16-12	X	5 d1
Fort Chaffee	Magazines igloo type	1916	642-535		5 d2
Fort Chaffee	Magazines igloo type	1916	652-535		5 d2
Fort Chaffee	Armament	1916	800-210		5 d2
Fort Chaffee	Oil House 25x 49'	1916	700-323		6 a
Fort Chaffee	Oil Shed	1916	700-384		6 a
Fort Chaffee	Heating Plant	1916	7093-501		6 a
Fort Chaffee	Station QM Office Boiler Hs.	1916	800-201		6 a
Fort Chaffee	Incinerator	1916	414/43/330		6 c
Fort Chaffee	Recreational Bldg.	1916	700-310		7 a
Fort Chaffee	Nurses Recreation Room	1916	800-451		7 a
Fort Chaffee	Med. Detachment Recr.	1916	800-459		7 a
Fort Chaffee	Recreation Bldg.	1916	800-460		7 a
Fort Chaffee	Sports Arena	1916	800-465		7 b
Fort Chaffee	Chapel	1916	700-1800		7 c
Fort Chaffee	Service Club	1916	700-1775		7 d

Sorted by: DATE

INSTALLATION	BUILDING	DATE	STD_PLAN	DRWNG	TYPE
Fort Chaffee	Officers'Club	1916	800-809		7 d
Fort Chaffee	Exchange	1916	700-297		7 f
Fort Chaffee	Post Exchange	1916	800-1412		7 f
Manual for QMC	Post Exchange, Mobilization Camps	1916	16-15	X	7 f
Fort Chaffee	Theatre w/Stage	1916	700-1212.1		7 g
Fort Chaffee	Nurses' Quarters	1916	700-1240		9 a1
Fort Chaffee	Guest House	1916	700-1290		9 a1
Manual for QMC	Officers Quarters, Lge, Mob. Camps	1916	16-2	X	9 a1
Manual for QMC	Officers Quarters, Sml, Mob. Camps	1916	16-3	X	9 a1
Fort Chaffee	Med. Detachment Barracks	1916	700-1204		9 a2
Fort Chaffee	Prisoner's Barracks	1916	800-443		9 a2
Manual for QMC	NCO Barracks, Mobilization Camps	1916	16-4	X	9 a2
Manual for QMC	Barrack, Enl'std Men, Mob. Camps	1916	16-5	X	9 a2
Fort Chaffee	Lavatory	1916	700-285		9 b1
Manual for QMC	Latrine, Mobilization Camps	1916	16-8	X	9 b1
Manual for QMC	Bath House, Mobilization Camps	1916	16-9	X	9 b1
Fort Chaffee	Officers Mess	1916	700-1127		9 b2
Fort Chaffee	Mess Patients	1916	700-44+A476		9 b2
Fort Chaffee	Medical Detachment Mess	1916	700-446		9 b2
Fort Chaffee	Officers' Mess	1916	700-450		9 b2
Fort Chaffee	Nurses' Mess	1916	700-451		9 b2
Fort Chaffee	152 Man Mess	1916	7093-921		9 b2
Fort Chaffee	112 Man Mess	1916	800-847		9 b2
Fort Chaffee	E.M. Mess	1916	800-849		9 b2
Fort Chaffee	E.M. Mess (M-248 less one 8'bay)	1916	800-851		9 b2
Manual for QMC	Kit. & Dining Rm, 72 Men, Mob. Cmps	1916	15-6	X	9 b2
Manual for QMC	Mess Building, Mobilization Camps	1916	16-6	X	9 b2
Manual for QMC	Kitchen, Mobilization Camps	1916	16-7	X	9 b2
Fort Chaffee	Officers'Quarters	1916	700-1254		9 c2
Fort Chaffee	Officers' Quarters	1916	700-1257		9 c2
Fort Chaffee	OfficersQuarters	1916	800-306		9 c2
Fort Chaffee	Officers' Quarters	1916	800-307		9 c2
Manual Cnstr Div	Fire Station, 24'x77'	1918	620-341		1 a
Manual Cnstr Div	Fire Station, 31'x88'	1918	620-365		1 a
Manual Cnstr Div	Fire Station, 31'x88'	1918	620-441		1 a
Manual Cnstr Div	Fire Station, 31'x103	1918	620-447		1 a
Manual Cnstr Div	Guard house, Regimental 20'x56'	1918	620-331		1 b
Manual Cnstr Div	Guard House, Type 1, 20x56	1918	652-214		1 b
Manual Cnstr Div	Admin. Building, 20' x 84'	1918	620-327		1 c
Manual Cnstr Div	Administration Building, 20'x49'	1918	620-356		1 c
Manual Cnstr Div	Welfare Bldg, 84x96	1918	6399-120		1 c
Manual Cnstr Div	Post Office Building, 32x51	1918	620-374		1 d
Manual Cnstr Div	Cantonment: R'mnt Sta 7500 Animals	1918	404-48	X	10 b1
Manual Cnstr Div	Stable - open 24xvar.	1918	620-376		10 b1
Manual Cnstr Div	Hay Shed, 60'x165'	1918	620-378		10 b1
Manual Cnstr Div	Stable - closed, 29xvar.	1918	SB 17	X	10 b1
Manual Cnstr Div	Auto & Mtr Serv Sta, 35'x41'	1918	620-397		10 c1
Manual Cnstr Div	Shop, Motor Repair, 60x130	1918	620-387 & 388		10 c2
Manual Cnstr Div	Shop, Motor Repair, 75x96	1918	620-478 & 479		10 c2
Manual Cnstr Div	Storage, Vehicles # 3, 161xvar	1918	652-188		10 c2
Manual Cnstr Div	Storage, Vehicles, #1, 113x513	1918	652-43		10 c2

Sorted by: DATE

INSTALLATION	BUILDING	DATE	STD_PLAN	DRWNG	TYPE
Fort Lewis, WA	Trestle, Coal	1918	RR 9	X	10 d1
Manual Cnstr Div	Standard Railway Trestle	1918	RR-1	X	10 d1
Manual Cnstr Div	Std. Railway Coal Trestle	1918	RR-2	X	10 d1
Manual Cnstr Div	Std. Timber Coal Pocket	1918	RR-3	X	10 d1
Manual Cnstr Div	Std. Trestle Bumper, Railways	1918	RR-5	X	10 d1
Manual Cnstr Div	Turnout & Crossover, Railways	1918	RR-4	X	10 d2
Manual Cnstr Div	Roadbed Sectons, Railways	1918	RR-6	X	10 d2
Manual Cnstr Div	Cantonment: Div HQ	1918	610-221 & 227	X	11 a
Manual Cnstr Div	Cantonment: Rgmt Inf, Brigd HQ	1918	610-222	X	11 a
Manual Cnstr Div	Cantonment: Rgmt Lt Art'ly	1918	610-225	X	11 a
Manual Cnstr Div	Contonment: Rgmt Hvy Art'ly	1918	610-226	X	11 a
Manual Cnstr Div	Cantonment: Camp Center	1918	610-232	X	11 a
Manual Cnstr Div	Cantonment: Depot Brgd HQ	1918	610-233	X	11 a
Manual Cnstr Div	Cantonment: RR Terminal	1918	610-238	X	10 d1
Manual Cnstr Div	Cantonment: Qrnt'n Camp 1000 men	1918	610-274	X	11 a
Manual Cnstr Div	Road Cross Section, Typical	1918	LA-1	X	10 c2
Manual Cnstr Div	Elec Distrib Syst, Street Lighting	1918	SB 11	X	6a
Manual Cnstr Div	Elec Distrib Syst, 2ndary Lines	1918	SB 12	X	6a
Manual Cnstr Div	Northern & Southern Constr Zones	1918	620-320-2-182	X	11a
Manual Cnstr Div	Typical 1 Story Building	1918	SB 1	X	11a
Manual Cnstr Div	Typical 2 Story Building	1918	SB 2	X	11a
Manual Cnstr Div	Typical 2 Sty Building, Details	1918	SB 3	X	11a
Manual Cnstr Div	Road Cross Sections, Typical	1918	LA-2	X	10c2
Manual Cnstr Div	Terminal General Plan	1918	RR-7	X	11a
Manual Cnstr Div	Terminals General Plans	1918	RR-8	X	11a
Manual Cnstr Div	Tel. & Teleg. Bldg, 20x70	1918	620-328		2 b
Manual Cnstr Div	Telegraph office & Quarters. 20x110	1918	620-418		2 b
Manual Cnstr Div	Gas Instruction, 16x30	1918	6143-2		3 a
Manual Cnstr Div	Classroom Building, 30' x 60'	1918	620-450		3 a
Manual Cnstr Div	Classroom Building, 49'x150	1918	620-469 & 470		3 a
Manual Cnstr Div	Classroom Building, 30'x60'	1918	620-507		3 a
Manual Cnstr Div	Infirmary - Medical, 30'x63'	1918	620-302		4 a
Manual Cnstr Div	Infirmary & Dental Ops Bldg. 30'x88	1918	620-307 & 308		4 a
Manual Cnstr Div	Infirm./Dntl Dorm Bldg, 30'x88'	1918	620-310 & 311		4 a
Manual Cnstr Div	Infirmary - Medical, Addition, 24'x	1918	620-333		4 a
Manual Cnstr Div	Infirmary - Medical, 30'x77'	1918	620-368 to 375		4 a
Manual Cnstr Div	Infirmary - Medical, 30'x105'	1918	620-382		4 a
Manual Cnstr Div	Infirmary - Medical, 30'x112'	1918	620-383 & 384		4 a
Manual Cnstr Div	Infirmary - Medical, 30'x98'	1918	620-392 & 393		4 a
Manual Cnstr Div	Infirmary - Medical, 30'x56'	1918	620-449		4 a
Manual Cnstr Div	Delousing Plant, 48x84	1918	632-551		4 a
Manual Cnstr Div	Delousing Plant, 60x204	1918	632-552		4 a
Manual Cnstr Div	Recruit Exam. Bldg / Shop	1918	SB 19	X	4 a
Manual Cnstr Div	Delousing Plant, 54x120	1918	SB 21	X	4 a
Manual Cnstr Div	Detention Hut, 20'x20'	1918	620-326		4 b
Manual Cnstr Div	Garage for Ambulances, 22'x47'	1918	620-496		4 b
Manual Cnstr Div	Hospital Typ Kitchen Layouts	1918	SB 14	X	4 b
Manual Cnstr Div	Layout: Hospital	1918	SGO-A	X	4 b
Manual Cnstr Div	Layout: Head House	1918	SGO-A1	X	4 b
Manual Cnstr Div	Typical Hosp Admin Bldg	1918	SGO-B	X	4 b
Manual Cnstr Div	Typical Hosp Laboratory Bldg	1918	SGO-F	X	4 b
Manual Cnstr Div	Typical Hosp Operating Pavillion	1918	SGO-G	X	4 b

Sorted by: DATE

INSTALLATION	BUILDING	DATE	STD_PLAN	DRWNG	TYPE
Manual Cnstr Div	Typical Hosp General Mess & Kitchen	1918	SGO-I1 & I32	X	4 b
Manual Cnstr Div	Typical Hosp General Mess & Kitchen	1918	SGO-I28	X	4 b
Manual Cnstr Div	Typical Hosp Receiving Ward	1918	SGO-J	X	4 b
Manual Cnstr Div	Typical Hosp Single Wards	1918	SGO-K1	X	4 b
Manual Cnstr Div	Typical Hosp Single Wards	1918	SGO-K34	X	4 b
Manual Cnstr Div	Typical Hosp Single Wards	1918	SGO-K35	X	4 b
Manual Cnstr Div	Typ. Hosp Phys Thrpy & Amusmnt Hall	1918	SGO-S & T	X	4 b
Manual Cnstr Div	Shop, 20x36	1918	620-372		5 a
Manual Cnstr Div	Shop, Clothing etc 30x102	1918	620-381		5 a
Manual Cnstr Div	Shop, QMaster, 2 bldgs each, 36x106	1918	620-390		5 a
Manual Cnstr Div	Stable Guard , 20x21	1918	620-395		5 a
Manual Cnstr Div	Shop, Cot repair, 40x36	1918	620-436		5 a
Manual Cnstr Div	Shop, Clothing, etc, 60x100	1918	620-437		5 a
Manual Cnstr Div	Shop, Tent Treating, 36x40	1918	620-439		5 a
Manual Cnstr Div	Shop, Tent Repair, 40x60	1918	620-440		5 a
Manual Cnstr Div	Shop, Clothing, etc 28x132, 28x162	1918	620-467		5 a
Manual Cnstr Div	Ordnance Repair Shop 30x106	1918	620-508		5 a
Manual Cnstr Div	Shop, Ordnance Repair, 30x80	1918	652-19		5 a
Manual Cnstr Div	Rendering Plant, 32x48	1918	620-435		5 b
Manual Cnstr Div	Coffee Roasting & Grinding Plant	1918	620-490 & 491		5 b
Manual Cnstr Div	Pyrotech Plant Type D, 20x35	1918	652-152		5 b
Manual Cnstr Div	Pyrotech Plant Type 1 & 2, 30x161	1918	652-157		5 b
Manual Cnstr Div	Pyrotech Plant Type J & J1, 20x35	1918	652-158		5 b
Manual Cnstr Div	Refrigerating & Ice Making Plant	1918	SB 28	X	5 b
Manual Cnstr Div	Bakery, 30'x70'	1918	620-340		5 c1
Manual Cnstr Div	Bakery, 40'x136 & 51'x62'	1918	620-361 & 362		5 c1
Manual Cnstr Div	Bakery, 40'x136'	1918	620-379		5 c1
Manual Cnstr Div	Bakery, 30'x50'	1918	620-428		5 c1
Manual Cnstr Div	Bakery 33'x51'	1918	620-505		5 c1
Manual Cnstr Div	Laundry, 72x216, 5-10,000 men	1918	633-130		5 c2
Manual Cnstr Div	Laundry, 36x108, 1-2,000 men	1918	633-140		5 c2
Manual Cnstr Div	Standard Laundry, 10-20,000 men	1918	SB 20		5 c2
Manual Cnstr Div	Store House, Regmtl, 20xvar.	1918	620-318		5 d1
Manual Cnstr Div	Warehouse, Clothing, 60x100	1918	620-385 & 386		5 d1
Manual Cnstr Div	Store House, Salvage, 60x168	1918	620-412 & 413		5 d1
Manual Cnstr Div	Storage Depot/admin Bldg, 140x160	1918	6271-7		5 d1
Manual Cnstr Div	Storehouse, General, #1, 161x501	1918	652-41		5 d1
Manual Cnstr Div	Storehouse, General, #2	1918	652-74		5 d1
Manual Cnstr Div	Typ Em'gncy Str'g Whse Toilet Rms	1918	SB 10	X	5 d1
Manual Cnstr Div	Store House, Divisional, 60x168	1918	SB 16	X	5 d1
Manual Cnstr Div	Em'gncy Whse C'prmt & Group Plan	1918	SB 25	X	5 d1
Manual Cnstr Div	Typ. Em'gncy Str'g Whse Admin Bldg	1918	SB 26	X	5 d1
Manual Cnstr Div	Em'gncy Whse, Open Shed	1918	SB 27	X	5 d1
Manual Cnstr Div	Magazine, Black P'wdr, 16x22	1918	6196-104		5 d2
Manual Cnstr Div	Shed - Wagon or Gun, 29xvar.	1918	620-332		5 d2
Manual Cnstr Div	Magazine, 20'x20'	1918	620-370		5 d2
Manual Cnstr Div	Magazine, 24'x60'	1918	620-371		5 d2
Manual Cnstr Div	Magazine, brick w/corr steel rf, 10	1918	620-452		5 d2
Manual Cnstr Div	Magazine, Smokeless pwdr, 32x96	1918	652-146		5 d2
Manual Cnstr Div	Shed, Dock, 60x122	1918	652-165		5 d2
Manual Cnstr Div	Magazine, Type 13, 26x42	1918	652-169		5 d2
Manual Cnstr Div	Primer & Fuse house #1, 32x96	1918	652-173		5 d2

Sorted by: DATE

INSTALLATION	BUILDING	DATE	STD_PLAN	DRWNG	TYPE
Manual Cnstr Div	Primer & Fuse house #2, 32x96	1918	652-174		5 d2
Manual Cnstr Div	Magazine, Type 10, 49x208	1918	652-179		5 d2
Manual Cnstr Div	Magazine, Type 11, H.E. 26x42	1918	652-180		5 d2
Manual Cnstr Div	Magazine, Type 12, 26x42	1918	652-31		5 d2
Manual Cnstr Div	Magazine, Type 1 & Type 2	1918	SB 23	X	5 d2
Manual Cnstr Div	Oil house, 20x30	1918	620-396		6 a
Manual Cnstr Div	Boiler Houses	1918	620-492		6 a
Manual Cnstr Div	Transformer Sta. Type 1, 20x36	1918	652-81		6 a
Manual Cnstr Div	Hose House (Type A & B) 6'x7'	1918	620-445 & 446		6 b
Manual Cnstr Div	Waste & Transfer Station, 20x130	1918	620-432		6 c
Manual Cnstr Div	Standard Incinerator	1918	SB 8	X	6 c
Manual Cnstr Div	Lecture Hall, 51x77	1918	608-104		7 a
Manual Cnstr Div	Auditorium, 200x300	1918	SB 24	X	7 a
Manual Cnstr Div	Post Exchange, 32x91	1918	620-359		7 f
Manual Cnstr Div	Theatre, Class a, 120x187	1918	608-24		7 g
Manual Cnstr Div	Theatre, Liberty, Class D	1918	608-31to34&106		7 g
Manual Cnstr Div	Liberty Theatre, 60x120	1918	620-499 & 500		7 g
Manual Cnstr Div	Barrack, 30'x60'	1918	620-313		9 a2
Manual Cnstr Div	Barrack, 30'x50'	1918	620-342		9 a2
Manual Cnstr Div	Dtchmnt Bar., w/out mess 20' x var.	1918	620-353		9 a2
Manual Cnstr Div	Detach. Bar., w/mess 20' x var.	1918	620-355		9 a2
Manual Cnstr Div	Barrack, 30'x40'	1918	620-366		9 a2
Manual Cnstr Div	Prisoner's Barrack & Yard, 30'x9	1918	620-373		9 a2
Manual Cnstr Div	Guard Barrack, 30'x90'	1918	620-373-A		9 a2
Manual Cnstr Div	Barrack & lavatory, 43'x120'	1918	620-457 & 458		9 a2
Manual Cnstr Div	Dormitory for men, 28x113	1918	6307-110		9 a2
Manual Cnstr Div	Dormitory & Dining Room, 29x136	1918	6339-111		9 a2
Manual Cnstr Div	Dormitories w/Mess	1918	SB 22	X	9 a2
Manual Cnstr Div	Typical Barracks, 66 Men	1918	SB 4	X	9 a2
Manual Cnstr Div	Lav. w/out shwrs: 17x14, 17x21, 17x	1918	620-324		9 b1
Manual Cnstr Div	Bath House, 9'x8' to 9'x32'	1918	620-336		9 b1
Manual Cnstr Div	Lavatory w/showers, 20x49	1918	620-345		9 b1
Manual Cnstr Div	Lavatory w/showers, 20x42	1918	620-346		9 b1
Manual Cnstr Div	Lavatory w/showers, 20x35	1918	620-347		9 b1
Manual Cnstr Div	Lavatory w/showers, 20x21, x28	1918	620-348		9 b1
Manual Cnstr Div	Lavatory w/showers, 14x14, 14x20	1918	620-349		9 b1
Manual Cnstr Div	Shower shelter & wash house, 20x80	1918	620-451		9 b1
Manual Cnstr Div	Lavatory w/showers, 20x50	1918	620-523		9 b1
Manual Cnstr Div	Typical Lavatories	1918	SB 6	X	9 b1
Manual Cnstr Div	Typical Lavatories Details	1918	SB 7	X	9 b1
Manual Cnstr Div	Meat Inspection Platform, 10'x66'	1918	620-429		9 b2
Manual Cnstr Div	Mess Building, 30x120 , x132, x144	1918	620-442		9 b2
Manual Cnstr Div	Refrigeration Plant, 20x72	1918	620-471 & 472		9 b2
Manual Cnstr Div	Regrigeration Cooling Tower,	1918	620-473		9 b2
Manual Cnstr Div	Cafeteria, 105x192	1918	6209-113		9 b2
Manual Cnstr Div	Cafeteria, 54x189	1918	6339-131		9 b2
Manual Cnstr Div	Cafeteria, 132x173	1918	6370-106		9 b2
Manual Cnstr Div	Cafeteria, 110x171	1918	6383-110		9 b2
Manual Cnstr Div	Cafeteria, 156x200	1918	6403-111		9 b2
Manual Cnstr Div	Typ Hospital Kitchen Layouts	1918	SB 13	X	9 b2
Manual Cnstr Div	Typical Mess Buildings	1918	SB 15	X	9 b2
Manual Cnstr Div	Det Hut & Kitchen, Det & Qrntn Camp	1918	SB 18	X	9 b2

Sorted by: DATE

INSTALLATION	BUILDING	DATE	STD_PLAN	DRWNG	TYPE
Manual Cnstr Div	Housing, 4 families, 38x53	1918	6309-121		9 c1
Manual Cnstr Div	Housing, 1 family, 24x30	1918	6309-150		9 c1
Manual Cnstr Div	Housing, Boarding, 27x38	1918	6309-160		9 c1
Manual Cnstr Div	Housing, 1 family, 24x36	1918	6309-180		9 c1
Manual Cnstr Div	Housing, 1 family, 24x32	1918	6309-190		9 c1
Manual Cnstr Div	Housing, 2 family, 25x36	1918	6309-200		9 c1
Manual Cnstr Div	Officers Quarters, 20x49	1918	620-337		9 c2
Manual Cnstr Div	Officers Quarters, 30xvar.	1918	620-343		9 c2
Manual Cnstr Div	Officers Quarters, 20x28	1918	620-344		9 c2
Manual Cnstr Div	Officers Quarters, 30xvar.	1918	620-354		9 c2
Manual Cnstr Div	Officers Quarters, 20xvar.	1918	620-363		9 c2
Manual Cnstr Div	Officers Quarters, 20xvar.	1918	620-364		9 c2
Manual Cnstr Div	Officer's Qtrs, 20x21 types A,B,C	1918	620-369		9 c2
Manual Cnstr Div	Typical 2 Story Officers Qtrs	1918	SB 5	X	9 c2
Manual Cnstr Div	Garage, 50' x var.	1918	620-301		9 d1
Manual Cnstr Div	Garage, 65' x 108'	1918	620-322 & 323		9 d1
Manual Cnstr Div	Garage, 30' x var.	1918	620-511		9 d1
Manual Cnstr Div	Garage, open, 50'xvar.	1918	620-524		9 d1
Manual Cnstr Div	Garage, closed, 70'x180'	1918	620-525		9 d1
Manual Cnstr Div	Garage, Mechanical Repair, 140x144	1918	6242-5		9 d1
Manual Cnstr Div	Garage, 61x164	1918	6311-105		9 d1
Manual Cnstr Div	Garage, Ordinance, 50xvar.	1918	652-17		9 d1
Manual Cnstr Div	Standard Steel & Wood Hangars	1919	SB 9	X	10 a1
F.E. Warren AFB	Hay Shed	1926	102-F		10 b
Fort Riley, KS	Frame Quarters for NCO	1928	Geo. E. Pond	X	9 c1
Fort Riley, KS	4 Family Apt. House, Company Ofcrs	1928	625-803		9 c2
Chief of Air Cor	Air Corps Hangar	1930	695-272	X	10 a1
Fort Riley, KS	Typical Dry Cleaning Plant	1930	633-165		5 c2
Fort McPherson	Clinic 28 beds, 34x130, 9x30	1930	6217-36 to 45		5 d1
Fort McPherson	Kitchen & Mess, 24x100, 31x33	1930	6217-47 to 57		9 b2
Fort Riley, KS	Double NCO Quarters, 2 sty, brick	1930	625-1444		9 c1
Fort Riley, KS	Double NCO Quarters 2 sty, brick	1930	625-1530	X	9 c1
Fort Riley, KS	Double NCO Quarters, w sty, brick	1930	625-1543		9 c1
Fort Riley, KS	NCO Double Quarters	1930	625-541	X	9 c1
Fort Riley, KS	4 Family Apt. House, Company Ofcrs	1930	625-806	X	9 c2
Fort Riley, KS	Four Family Apartment House	1930	625-808	X	9 c2
Chief of Air Cor	Air Corps Hangar, E Design	1931	695-284	X	10 a1
F.E. Warren AFB	Utility Office	1931	59-U		6 b
F.E. Warren AFB	Detachment Barracks	1931	621-850 & 851		9 a2
F.E. Warren AFB	Double NCO Quarters	1931	8682-D		9 c1
Fort D.A. Russel	Double NCO Quarters	1931	625-1543 & 1544		9 c1
F.E. Warren AFB	Company Ofcr 4 Set Apt	1931	129		9 c2
Fort Riley, KS	Q.M. Gas Station	1932	A-5-21	X	10 c1
Fort Riley, KS	NCO Quarters - type c - brick	1932	625-1556	X	9 c1
F.E. Warren AFB	Company Officer's Quarters	1932	625-1486 & 87		9 c2
Fort Riley, KS	Field Officers Quarters	1932	625-1341	X	9 c2

Sorted by: DATE

INSTALLATION	BUILDING	DATE	STD_PLAN	DRWNG	TYPE
Marshall Field,	Field Officers Quarters	1932	625-1301	X	9 c2
Marshall Field,	Company Officers Quarters	1932	625-2491	X	9 c2
Fort McPherson	Nurses Quarters, 13 nurses	1933	707-102 to 107		9 a1
F.E. Warren AFB	Double NCO Quarters, type B	1933	625-2510 & 2518		9 c1
F.E. Warren AFB	Double NCO Quarters, type A	1933	625-2510 - 2511		9 c1
Fort D.A. Russel	Double NCO Quarters	1933	625-2510 & 2511		9 c1
Marshall Field,	Field Officers Quarters	1933	625-1340	X	9 c2
Fort Lewis, WA	Magazine, Post Ordnance	1934	19-2-70	X	5 d2
Office of QMG	Typ L'scp Pl'tg: CO & Dbl CO Qtrs	1935	630-100	X	11 a
Office of QMG	Typical Street Tree Planting	1935	630-102	X	11 a
Office of QMG	Typ L'scp Pl'tg: Th'tre, Hosp, Chpl	1935	630-103	X	11 a
Office of QMG	Typ. L'scp Pl'tg: HQ, Admin, BOQ	1935	630-Illegible	X	11 a
Fort Riley, KS	Double NCO Quarters, 2 sty, brick	1935	625-3571	X	9 c1
Fort Riley, KS	Double NCO Quarters, 2 sty, brick	1935	625-3572	X	9 c1
Fort Riley, KS	Post Office, Type PO-1	1937	700-298	X	1 d
Fort Riley, KS	Shop - Utilities	1937	700-317	X	5 a
Fort Riley, KS	Revised Plan of Engineer Garage	1937	A-20-12	X	9 d1
Fort Riley, KS	Stables	1938	14-7-illegible	X	10 b1
Fort Riley, KS	Stables	1938	14-9-illegible	X	10 b1
Fort Riley, KS	Stable	1938	A-14-4		10 b1
Fort Riley, KS	Academic Building	1938	6139-310	X	3 a
Fort Riley, KS	Packing & Crating shop	1938	A-8-12	X	5 a
Fort Riley, KS	Incinerator	1938	A-13-1		6 c
Fort Riley, KS	Barracks	1938	A-19-14		9 a2
Marshall Field,	Barracks	1938	621-1072	X	9 a2
Fort Riley, KS	Double NCO Quarters, 2 sty, stone	1938	625-3570-3	X	9 c1
Fort Riley, KS	Double NCO Quarters, 2 story, stone	1938	625-3571-3	X	9 c1
Fort Riley, KS	Double NCO Quarters, 2 story stone	1938	625-3572-3	X	9 c1
Fort Riley, KS	Quarters, no designation	1938	A-4-9	X	9 c2
Fort Riley, KS	Stable - School of Equitation	1939	A-14-12	X	10 b1
Fort Riley, KS	Dispatcher's Office	1939	A-19-4		10 c2
Fort McPherson	Dental Clnc & Cont. Ward, 34x130	1939	6217-65, 74, 76		4 a
F.E. Warren AFB	Incinerator - trash only	1939	414-43-228		6 c
F.E. Warren AFB	War Dept Theatre	1939	608-360 to 366		7 g
Fort D.A. Russel	War Dept Theater	1939	608-360 - 366		7 g
Fort McPherson	War Dept Theatre, 85x49	1939	6217-105 to 107		7 g
F.E. Warren AFB	Med Dchmnt Bar (and 6560-140--142)	1939	621-1325--1346		9 a2
F.E. Warren AFB	Medical Detachment Bar	1939	6560-140--142		9 a2
Fort D.A. Russel	Med. Detachment Barracks	1939	6560-140 - 142		9 a2
Fort Riley, KS	Quarters, no designation	1939	A-2-3	X	9 c1
Fort Riley, KS	Quarters, no designation	1939	A-4-7	X	9 c2
Marshall Field	Operations Building	1940	613-9365		1 c
Marshall Field,	Operations Building	1940	6139-366		1 c
Fort Riley, KS	Infirmary - Large	1940	700-279		4 a
Marshall Field,	Paint Oil & Dope House	1940	702-118	X	5 d1

Sorted by: DATE

INSTALLATION	BUILDING	DATE	STD_PLAN	DRWNG	TYPE
Fort D.A. Russel	Gymnasium	1940	6560-145 - 179		7 b
Fort Riley, KS	NCO Garages	1940	A-20-7	X	9 d
Fort Riley, KS	Sewage Treat. Plnt, Cntrl Hse	1942	408-204	X	6 b
Fort Riley, KS	Cold Storage Bldg	1942	800-1226	X	5 d1
Fort Riley, KS	Admin Bldg? No Title	N.D.	6139-307	X	1 c
Fort Riley, KS	Administration Building	N.D.	Geo. E. Pond		1 c
Fort Riley, KS	Proposed Administration Building	N.D.	Geo. E. Pond		1 c
Fort Riley, KS	Airplane Hangar	N.D.	Butler Mfg Co	X	10 a1
Fort Riley, KS	Battery Stables	N.D.	E.B. Williston	X	10 b1
Fort Riley, KS	Cavalry Stables	N.D.	Geo. E. Pond	X	10 b1
Fort Riley, KS	Dispensary	N.D.	Geo. E. Pond	X	4 a
Fort Riley, KS	Battery Workshops	N.D.	Geo. E. Pond	X	5 a
Fort Riley, KS	Ordnance Store House	N.D.	Geo. E. Pond	X	5 d2
Fort Riley, KS	Post Exchange & Gymnasium	N.D.	Geo. E. Pond	X	7 a
Fort Riley, KS	B.O.Q.	N.D.	188	X	9 a1
Fort Riley, KS	Quarters for Packers	N.D.	A-2-17	X	9 a2
Fort Riley, KS	Cavalry Barracks	N.D.	Geo. E. Pond	X	9 a2
Fort Riley, KS	Outhouse for Cavalry Barracks	N.D.	Geo. E. Pond	X	9 b1
Fort Riley, KS	Non-Commissioned Officers Quarters	N.D.	Geo. E. Pond	X	9 c1
Fort Riley, KS	Quarters for Steam Heating Engineer	N.D.	Geo. E. Pond	X	9 c1
Fort D.A. Russel	Company Officrs Qtrs	N.D.	625-1486 &1487		9 c2
Fort Riley, KS	Proposed Field Officrs Quarters	N.D.	Geo. E. Pond	X	9 c2
Fort Riley, KS	Quarters for Commanding Officer	N.D.	Geo. E. Pond	X	9 c2

G. BIBLIOGRAPHY

1) BOOKS

- Adams, George W., *Doctors in Blue: The Medical History of the Union Army in the Civil War*. New York, Henry Schuman, 1952.
- Anderson, Lieut.-Colonel. "Army Posts, Barracks and Quarters" *Journal of the Military Service Institution of the United States II* (1880).
- Army Times. *History of the U.S. Signal Corps*. New York, G.P. Putnam's Sons, 1961.
- Asburn, Percy. *A History of the Medical Department of the United States Army*. Boston, Houghton Mifflin Company, 1929.
- Brown, Jerold E. *Where Eagles Land: Planning and Development of U.S. Army Airfields 1910-1941*. Westport, Connecticut, Greenwood Press, 1990.
- Carson, J.M. "Now--the Army Apartment" *The Quartermaster Review*. July-August 1921, 71-73.
- Cary, Norman, M. *The Use of the Motor Vehicle in the United States of Army*, Ph.D. diss., University of Georgia, 1980.
- Chambers, Lt. Col. John S., "Quarters for the Army", *The Quartermaster Review*, March-April, 1928.
- Coffman, Edward. *The Old Army*. New York, Oxford University Press, 1986.
- Craig, Lois A., et. al., *The Federal Presence: Architecture, Politics, and National Design*, Cambridge: The MIT Press, 1984.
- DeZurko, Edward. "A Report and Remarks on Cantonment Leavenworth." *Kansas Historical Quarterly XV*, No. 4, November 1947, 353-359.
- Fine, Lenore and Remington, Jesse A. *The Technical Services: The Corps of Engineers: Construction in the United States*, Office of the Chief of Military History, United States Army, Washington, DC, 1972.
- Ford, George B., "New Army Posts for Old", *The Quartermaster Review*, November-December, 1929.
- Garner, John D. *World War II Temporary Military Buildings*. Champaign, Illinois, U.S. Army Construction Engineering Research Laboratory, 1993.

- Gillett, Mary C. *Army Medical Department 1818-1865*, Washington, D.C. Government Printing Office, 1987.
- Goodwin, R. Christopher and Associates, *National Historic Context for Department of Defense Installations, 1790-1940; Volume I, II & III*, Baltimore, MD: United States Army Corps of Engineers, 1995.
- Graham, John Paul, Mary Beth Gatza. and E. Kipling Wright. *The Architectural Heritage of Fort Monroe: Inventory and Documentation of Historic Structures Undertaken by The Historic American Buildings Survey*, Washington, DC, Department of the Interior, National Park Service, Historic American Buildings Survey/Historic American Engineering Record, 1987.
- Grashof, Bethanie C. *A Study of United States Army Family Housing Standardized Plans, 1866-1940*: Atlanta, Georgia: Georgia Institute of Technology for Headquarters Department of the Army and Historic American Buildings Survey (HABS), National Park Service, 1986.
- Hallauer, E. Mack. "Landscaping the Army Post", *The Quartermaster Review*, July-August 1939, 28-31.
- Hucles, Michael E., *From Haversack to Checkout Counter: A Brief History of the Army Commissary System*, Fort Lee, Virginia U.S. Army Troop Support Agency, 1991.
- Interagency Resources Division, National Park Service, "How to Complete the National Register Multiple Property Documentation Form", *National Register Bulletin 16B* Washington, 1991.
- Ireland, Merritte W., *The Medical Department of the United States Army in the World War*. Washington, D.C., Government Printing Office, 1929.
- Kriv, Arlene R., Editor, *World War II and the U.S. Army Mobilization Program: A History of 700 and 800 series Cantonment Construction*, Washington, D.C.: Historic American Building Survey/Historic American Engineering Record, National Park Service for Legacy Resources Management Program, U.S. Department of Defense, 1993.
- Lavoie, Catherine C., *Wright Paterson Air Force Base, Brick Officers' Quarters* Washington: Historic American Engineering Record, HAER NO. OH-103, 1994.
- Manning, Thomas A., "Origins of Randolph AFB", MSS, Air Training Command. History Office, Randolph AFB, Texas, 1987.
- Matloff, Maurice, *American Military History*, Washington, DC, Government Printing Office, 1969.

Maurer, Maurer. *Aviation in the U.S. Army, 1919-1939*, Washington, DC, Government Printing Office, 1987.

Moulton, Robert H., "Semi-Military Buildings in the Army Cantonments", *The Architectural Record*, July, 1918.

National Park Service, Pacific Northwest Region, Cultural Resources Division, *Landscape Development Plan Fort Lewis, Washington: Volume I, Volume I, "Landscape History"* Jane Merritt, project historian, 1990.

Norton, Herman A., *Struggling for Recognition: The United States Army Chaplaincy, 1791-1865*, Washington, DC, Government Printing Office, 1977.

Nurse, 1st Lt. Howard B., "The Planning of Army Posts" in *The Quartermaster Review* September-October, 1928.

Pevsner, Nikolaus. *A History of Building Types*, Princeton, Princeton University Press, 1976.

Risch, Erna, *The Quartermaster Corps: Organization, Supply and Services, Volume I*, Washington, D.C.: Office of the Chief of Military History, United States Army, 1953.

Risch, Erna., *Quartermaster Support for the Army. A History of the Corps 1775-1939*. 1962. Reprint. Washington, D.C.: Government Printing Office, 1989.

Slattery, Thomas J. *An Illustrated History of the Rock Island Arsenal and Arsenal Island, Part Two*, Rock Island, Illinois, Historical Office, U.S. Army Armament, Munitions, and Chemical Command, 1990.

Stanley, Arthur J. "Fort Leavenworth: Dowager Queen of Frontier Posts." *The Kansas Historical Quarterly*. Vol. XIII, No. 1, Spring 1976.

Stover, Ead F. *Up from Handyman: The United States Army Chaplaincy, 1865-1920*. Washington, DC, Government Printing Office, 1977.

Thompson, Harry and Lida Mayo, *The Ordnance Department.- Procurement and Supply*, Washington, DC, Government Printing Office, 1960.

United States, Air Force, Historical Division, *The United States Air Arm, April 1861-1917*, Maxwell AFB, Alabama, Air University, 1958.

United States, Surgeon General's Office, *Plan for a Post Hospital of 24 Beds. (Circular 4)* Washington, DC, Government Printing Office, 1867.

United States, Surgeon General's Office, *Approved Plans and Specifications for Post Hospitals. (Circular No. 2)*, Washington, DC, Government Printing Office, 1871.

- United States. Surgeon General's Office. *Description of the Models of Hospitals and Tents.* (Exhibit-Class 1) New Orleans: The World's Industrial and Cotton Centennial Exposition, 1884.
- United States. War Department. *Annual Reports of the Quartermaster-General.* Washington, DC, Government Printing Office, 1872, 1875, 1893.
- United States, War Department, *Regulations Concerning Barracks and Quarters for the Army of the United States, 1860,* Washington, DC, George W. Bowman, 1861.
- United States, War Department, General Staff, *Manual for the Quartermaster's Department, United States Army, 1904,* Washington, DC, Government Printing Office, 1904.
- United States, War Department, *Manual for the Quartermaster Corps, United States Army, 1916, Volume 2, Appendix,* Washington, 1917.
- United States, War Department, *Manual of the Construction Division of the Army, Section C, Engineering Division, 1918,* Washington, 1919.
- United States, War Department, Inspector General's Office, *Outline Descriptions of the Posts and Station of Troops in the Geographical Divisions and Departments of the United States.* Washington, DC, Government Printing Office, 1872.
- United States, War Department, Surgeon-General's Office, *A Report on Barracks and Hospitals with Descriptions of Military Posts,* (Circular No. 4), Washington, DC, Government Printing Office, 1870.
- United States, War Department, Surgeon-General's Office, *A Report on the Hygiene of the United States Army with Descriptions of Military Posts,* (Circular No. 8) Washington, DC, Government Printing Office, 1875.
- United States, War Department, *Annual Report of the Secretary of War,* Washington, DC, Government Printing Office.
- Walker, Lois E. and Shelby E. Wickam, *From Huffman Prairie to the Moon,* Washington, DC, Government Printing Office, 1984.
- Wheaton, Lt. Col. Francis B. "The Architecture of the Army Post" *The Quartermaster Review.* September-October, 1928,10-13.
- Wood, David L., *A History of Tactical Communication Techniques,* Orlando, Martin Marietta Corporation, 1965.

2) RESOURCES LOCATED AT THE NATIONAL ARCHIVES

Selected records are grouped in Record Groups at the National Archives and may contain valuable information about Quartermaster Corps standardized plans. A record group is the basic of archival control and consists of a body of organizationally related records designated by a number and the name of the government agency, bureau, or activity that created or received them. Researchers usually gain access to records after reviewing guides to records, by using indexes to subjects and agencies and, at the most direct level, finding aids and microfilmed publications.

For example, the Pacific Northwest Regional Office of the National Archives in Seattle, Washington published in 1994 a *Guide to Records in the National Archives—Pacific Northwest Region*. Under the heading for Record Group 18, *Records of the Army Air Forces*, researchers will find a brief administrative history of the Army Air Forces, a short description of the records (dates covered, number of cubic feet of records and major headings), a summary of any finding aids (these range from no finding aids, to a list of box contents and inventory reports written by National Archives staff) and a list of any related microfilm publications

Due to time and budget constraints, it was not possible to examine all record groups (RG) relating to Quartermaster Corps standardized plans. RG 77, *Records of the Office of the Chief of Engineers*, and RG 92, *Records of the Office of the Quartermaster General*, were the focus of research.

Researchers may find that the following record groups also contain useful information. A brief administrative history is provided with each record group. The text for the administrative histories was taken from *Guide to Records in the National Archives—Pacific Northwest Region Seattle, Washington*.¹

RG 18 Records of the Army Air Forces

The Army Air Forces (AAF) originated August 1, 1907, as the Aeronautical Division in the Office of the Chief Signal Officer. After various reorganizations and name changes, the Army Air Forces was established on March 9, 1942, under the Secretary of War and the War Department General Staff.

RG 165 Records of the War Department General and Special Staffs

A War Department General Staff was authorized by Congress on February 14, 1903, to include a Chief of Staff, a General Council, and three divisions, which, after frequent reorganizations, developed into the Personnel Division (G-1), the Military Intelligence Division (G-2), the Organization and Training Division (G-3), the Supply Division (G-4), and

¹ Susan Karren, Laura McCarthy and Nancy Malan, National Archives and Records Administration, Washington, DC, 1994

the War Plans Division (Operations Division after 1942). The General Staff was a separate and distinct staff organization with supervision over most military branches—both line and staff. Its duties were to prepare plans for national defense and mobilization of military forces in time of war, to investigate and report on questions affecting Army efficiency and preparedness, and to give professional aid to the Secretary of War, general officers, and other superior commanders.

Under provisions of the National Security Act of 1947, the War Department became the Department of the Army within the newly created National Military Establishment, which was renamed the Department of Defense in 1949.

RG 219 Records of the Office of Defense Transportation

The Office of Defense Transportation (ODT) was created within the Office for Emergency Management on December 18, 1941, to ensure that the United States domestic transportation facilities were used to win the war in the most efficient manner. The ODT was authorized to coordinate activities of Federal agencies and private groups in adjusting the transportation system to the needs of the war, to determine adequacies of facilities and act to provide additional transportation, to coordinate transportation to prevent congestion, and to determine storage and warehouse requirements. ...After the war, ODT's responsibilities steadily diminished until the agency was terminated on July 1, 1949.

RG 338 Records of the Records of U.S. Army Commands

The present system of U.S. Army commands, which are organized both functionally and geographically, emerged from a War Department reorganization of February 28, 1942. Regional holdings include records of Quartermaster and Ordnance Depots. Related records are to be found in RG 92.

U.S. War Department, *The Annual Report of the Secretary of War*, Washington, DC, Government Printing Office. Annual Reports by The Secretary of War are available from 1852 to 1912. *The Report of the Quartermaster General* is included within the Secretary's reports (these are also published separately as *The Annual Report of the Quartermaster General*). These reports include a vast amount of useful information including budgets, expenditure reports including costs, type and location of buildings; General Orders are included which relate to construction activities; authorization to establish, abandon or sell posts; Etc.

Record Group 77: Records of the Office of the Chief of Engineers – Completion Reports

Standardized plans from the third period of standardization can often be found in this file consisting of at least 116 boxes of files. These files are arranged by post and usually contain separate files on individual buildings. Within the files can be found the Quartermaster Corps procurement authority, project description, construction and financial data, standard plan number, name of building contractor(s) and supplier(s), costs and schedule. Photographs are

often included showing a completed building. Occasionally a blueprint or a photograph of a floor plan will also be included.

Record Group 92, Entry 215 – Consolidated Correspondence Files, 1794-1890. Arranged by subject.

Time and budget constraints did not permit an examination of this huge collection of records. The following description is quoted from Grashof, *A Study of United States Army Family Housing Standardized Plans, Volume 1*, 1986.

“Potentially one of the most valuable files, and definitely one of the most frustrating to work with. It is an extremely large file. Since it is arranged by subject, the subjects barracks, quarters, officers’ quarters, housing family housing, plans, design, architecture, anything that might yield information [about] standardized construction, were requested. The response was that the file was generally arranged according to people, places and posts, though there are a number of boxes labeled Maps and Drawings. Unfortunately, these were reviewed too early in the research so no standardized plans could be recognized. ...Also requested was information on the various Military Departments and Quartermaster Generals. Little of value was found relating to standardized construction under these subject heads. With a number of plans identified from the early period, the next search in this file should be of the specific posts. There are usually plans included in these files which may or may not duplicate those at the Cartographic and Architectural Branch, and also specifications. This search would prove quite valuable.”

Record Group 92, Entry 1058 – *Annual Reports of the Construction and Repair Division, 1903-1915*.

Mimeographed and typed reports that were published, or edited for publication, in the annual reports of the Quartermaster General and the Secretary of War.

Record Group 92 Entry 1061 – *List of Construction Contracts Made for Various Posts, 1885-1899*.

Often indicates the Quartermaster Generals Office plan number used for and gives the building types at various posts.

Record Group 94 – *Records of the Adjutant General's Office, 1917- ----, Central Decimal File 620-625, 630*.

Documents dealing with various topics. Grashof, 1986 indicates that the :

“numbers 620-625, which covered barracks and quarters, officers quarters, etc. were requested. Only a portion of 620 was received, however, so there is much information still to be reviewed. Number 630- Post Buildings might also prove helpful. There does not

appear to be any organization, other than chronologically by date within the boxes of documents.”

A) CARTOGRAPHIC AND ARCHITECTURAL BRANCH
(Located at Archives II in College Park, MD)

Record Group 77	Fortification File
Record Group 77	Miscellaneous Fortification File
Record Group 92	Post and Reservation File
Record Group 156	Office of the Chief of Ordnance
Record Group 393	Posts

Over forty loose-leaf notebooks have been organized alphabetically by post name. Under each post is a listing of all drawings from that post within these files.

Record Group 77 Williams Number Map Collection

Maps showing a number of Army posts are included in this collection. Organized by state and by U.S. military stations, these original maps and blueprints offer a variety of information including proposed building construction, sewer and water lines, artillery range maps, mosaics of aerial photographs, topography,

Record Group 92 Blue Print File

Indexed by individual posts, the entries are arranged roughly by year. The drawings in this RG include topographic maps, post layouts including buildings and streets, floor plans for individual buildings and, in the typical case of Fort Sam Houston, Texas, there are even detail drawings of grease traps “to be used in connection with the proposed new sewer system.”

Record Group 77 – P.I. NM—19 (Entry 410: Index, and Entry 411: Plans) and
Record Group 92 – Post and Reservation File – Fort Anyplace

No specific post is represented in these files. The first, RG 77 – P.I. NM – 19 contains “all of the drawings for all types of post buildings from the second period of standardization.” (Grashof, 1986) The index includes written descriptions for each type. The second, RG 92 – Post and Reservation File – Fort Anyplace, includes blueprints of the drawings listed in NM—19.

B) STILL PHOTOS DIVISION

The following description of records in the Still Photos Division is copied from Grashof, 1986.

Record Group 77-A
and
Record Group 77-AA-

Prints and negatives from Washington Barracks (Ft. McNair) and Willet's Point (Ft. Totten). Some of the negatives are for prints in the 92-F series. Some photographs of quarters built from standard designs are included in this series.

Record Group 77-CA-

Completion photographs of housing from the second period of standardization. The photographs were taken at posts across the country, from Ft. Terry, New York to Ft. Stevens, Oregon. ...An occasional standard design from the first period of standardization was also illustrated.

Record Group 77-CC- Completion Photos of Military Housing Projects, 1927-1936.

There is no volume 1. An excellent source for third period designs. Volumes 2 and 3 have been taken apart and are now in two large archival boxes. Volume 4 is still bound and is sometimes difficult to find.

Record Group 77-SD- Military Installations of the Southern Department, 1920.

Photographs from posts in Texas, New Mexico and Arizona. Of little value except to show where already identified standardized plans were built.

Record Group 77-SFA-

Photographs of the posts around the San Francisco Harbor, especially Ft. Scott (the Presidio). Good photographs of housing built from standard plans of the second period of standardization.

Record Group 92-F Series-

US Military Posts of the late 19th Century. Excellent resource for early photographs of all building types. Arranged by post.

3) NATIONAL ARCHIVES, ALASKA REGION

Record Group 77 Records of the Office of the Chief of Engineers

The holdings of the National Archives, Alaska Region in Anchorage, Alaska, contain over 9,000 architectural and engineering drawings produced by the Alaskan offices of the US Army Corps of Engineers during World War II specifically for posts in Alaska. Since all World War II drawings prepared and archived in the Seattle District (which supervised construction by the Alaska office) were destroyed after the war, the Alaskan drawings constitute a unique record. They were not examined as part of this project as they were found too late in the project.

The drawings were often modified to adapt features of individual building types to Alaska's varied and extreme conditions: Arctic entries were added, roof trusses strengthened, additional insulation specified, Etc. Essentially a collection of construction drawings that provide detailed information about individual building types in Alaska, the collection includes both architectural elevations and floor plans. The drawings are indexed by post and the index appears to have been compiled from a database. No drawing numbers or sheet numbers identify each entry, and only the first one or two words of a drawing's title are included in the index. Roughly 95% of the entries present no problems as "Topography", "Plot Plan", "Elevation", "Motor Repair Shop" and "Warehouse" are helpful descriptions, but "Detector" or "Sleeve" is confusing.

4) ARCHIVES AND UNPUBLISHED MATERIAL

Building Location List, MSS, Directorate of Engineering and Housing, Ft. Monroe, Virginia, N.D.

Building Technology Incorporated, *Historic Properties Report: Fort Lewis Historic District and Vancouver Barracks Historic District*, MSS, Directorate of Environmental Quality, Ft. Lewis, Washington, 1986.

-----, *Historic Properties Report: Rock Island Arsenal, Rock Island, Illinois*, MSS, Army Materiel Command History Office, Rock Island Arsenal, Rock Island, Illinois, 1985.

-----, *Historic Properties Report: Watervliet Arsenal, Watervliet, New York*, MSS, Army Materiel Command History Office, Rock Island Arsenal, Rock Island, Illinois, 1985.

Clary, David A., *A Life Which is Gregarious in the Extreme: A History of Furniture in Barracks, Hospitals, and Guardhouses of the United States Army, 1880-1945*, MSS, Department of the Interior, National Park Service, Harpers Ferry Center, 1983.

-----, *These Relics of Barbarism: A History of Furniture in Barracks and Guardhouses of the United States Army, 1800-1880*, MSS, U.S. Department of the Interior, National Park Service, Harpers Ferry Center, 1983.

Cook, Jody, *Architectural and Historical Survey of Langley Air Force Base and Inventory of Historic Resources Langley Field, Virginia*, Draft MSS. National Park Service, Southeast Regional Office, Atlanta, Georgia, N.D.

Drucker, Lesley M., *Architectural and Historical Documentation of the Original Cantonment Area and Hangars 4 and 5, Pope Air Force Base, North Carolina*, Resource Studies Series 83, Carolina Archeological Services. MSS, Civil Engineering, Pope AFB, North Carolina, 1985.

Fort Leavenworth Historic Building Inventory, MSS, Directorate of Engineering and Housing, Ft. Leavenworth, Kansas, 1983.

National Archives and Records Administration. Record Group 77. Historical Records of Buildings, 1905-1942. Records of the Office of the Chief of Engineers. Standard Plans of Army Post Buildings, 1891-1918; Fortifications File.

National Archives and Records Administration. Records of the Office of the Quartermaster General. Record Group 92. Blueprint File; Consolidated Correspondence File; Post Plans 1904-1905; Post and Reservation File.

National Register of Historic Places Registration Forms. MSS, National Park Service, National Register of Historic Places, Washington, DC.

Peter, Duane et. al. *Phase 1: Cultural Resources Overview of Brooks Air Force Base, San Antonio, Bexar County, Texas*, Draft MSS, Civil Engineering, Brooks AFB, Texas, February 1992.

Robinson Fisher Associates, Inc. *Historic Building Survey: Fort Benning, Georgia*, MSS, Fort Benning, Georgia, 1987.

Simmons, R. Laurie, et al., *Cultural Resources Study: Fitzsimons Army Medical Center*, MSS, U.S. Army Corps of Engineers, Omaha District, 1991.

Schubert, Frank N., *Ft. Robinson, Nebraska: The History of a Military Community, 1874-1916*, Ph.D. diss., University of Toledo, 1976.